

**Canberra**

**4412193**

**1/8**

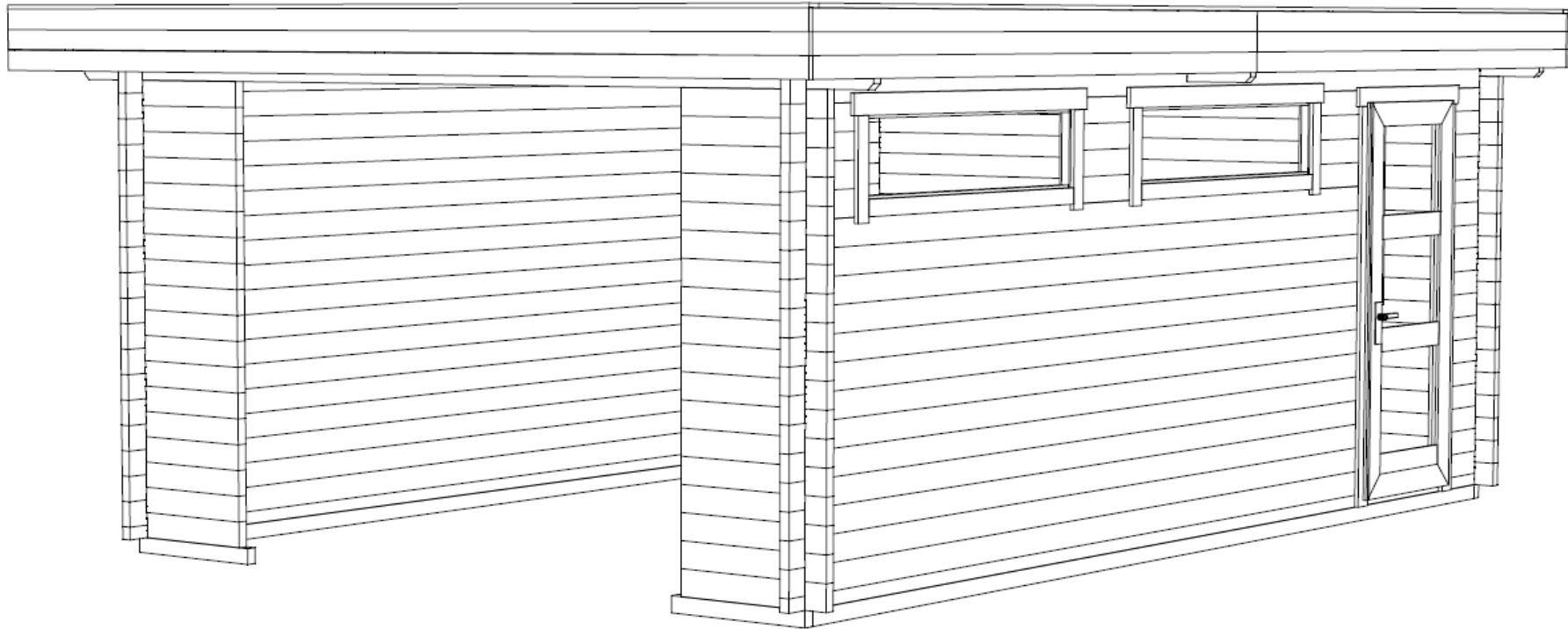

44x114

23.01.2018

Groundplan - Grundplan - Plan de masse - Planimetria - Plattegrond - Põhiplaan

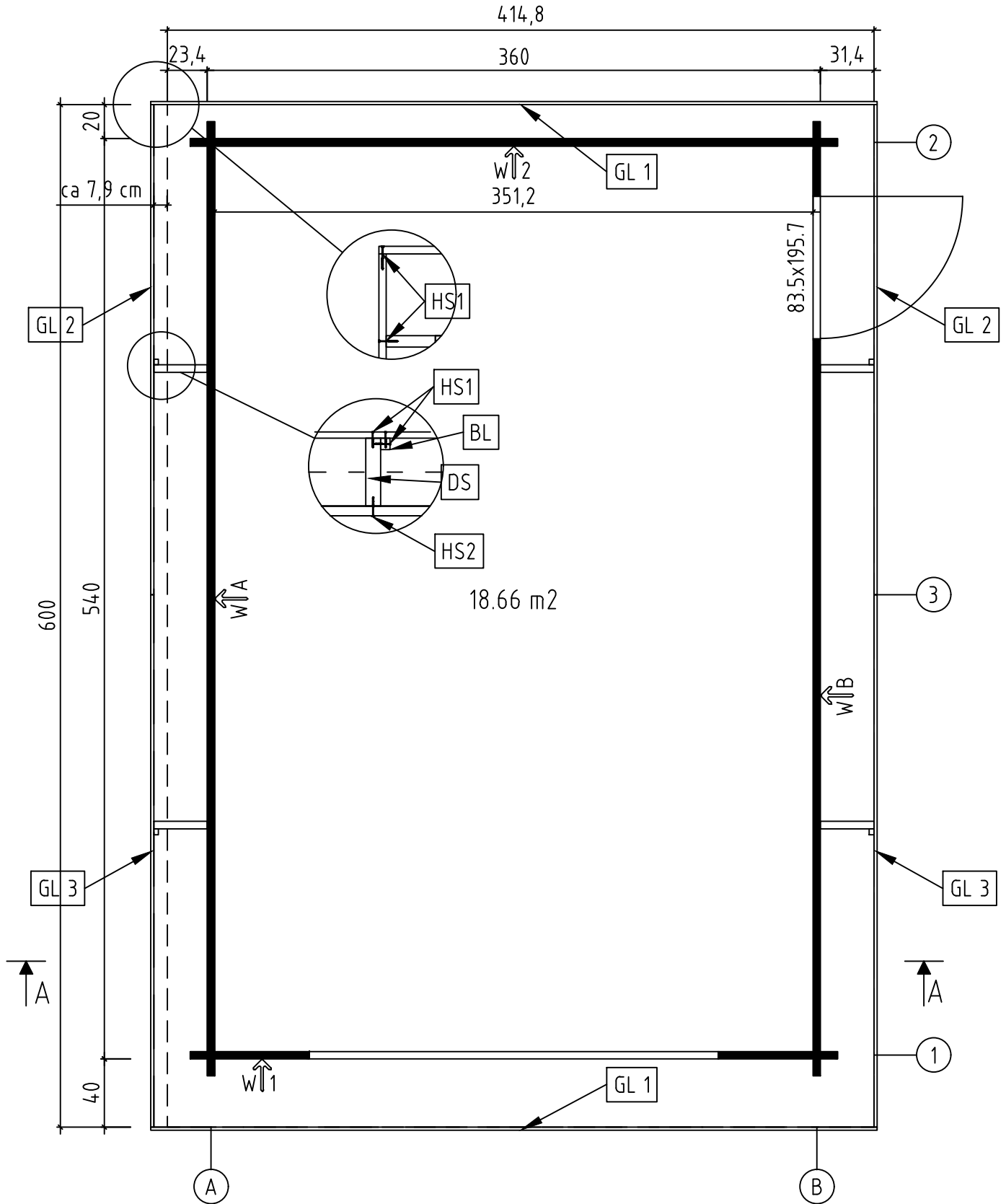

Foundation - Fundament - Fondation - Fondamenta - Fundering - Immutatud alusraam

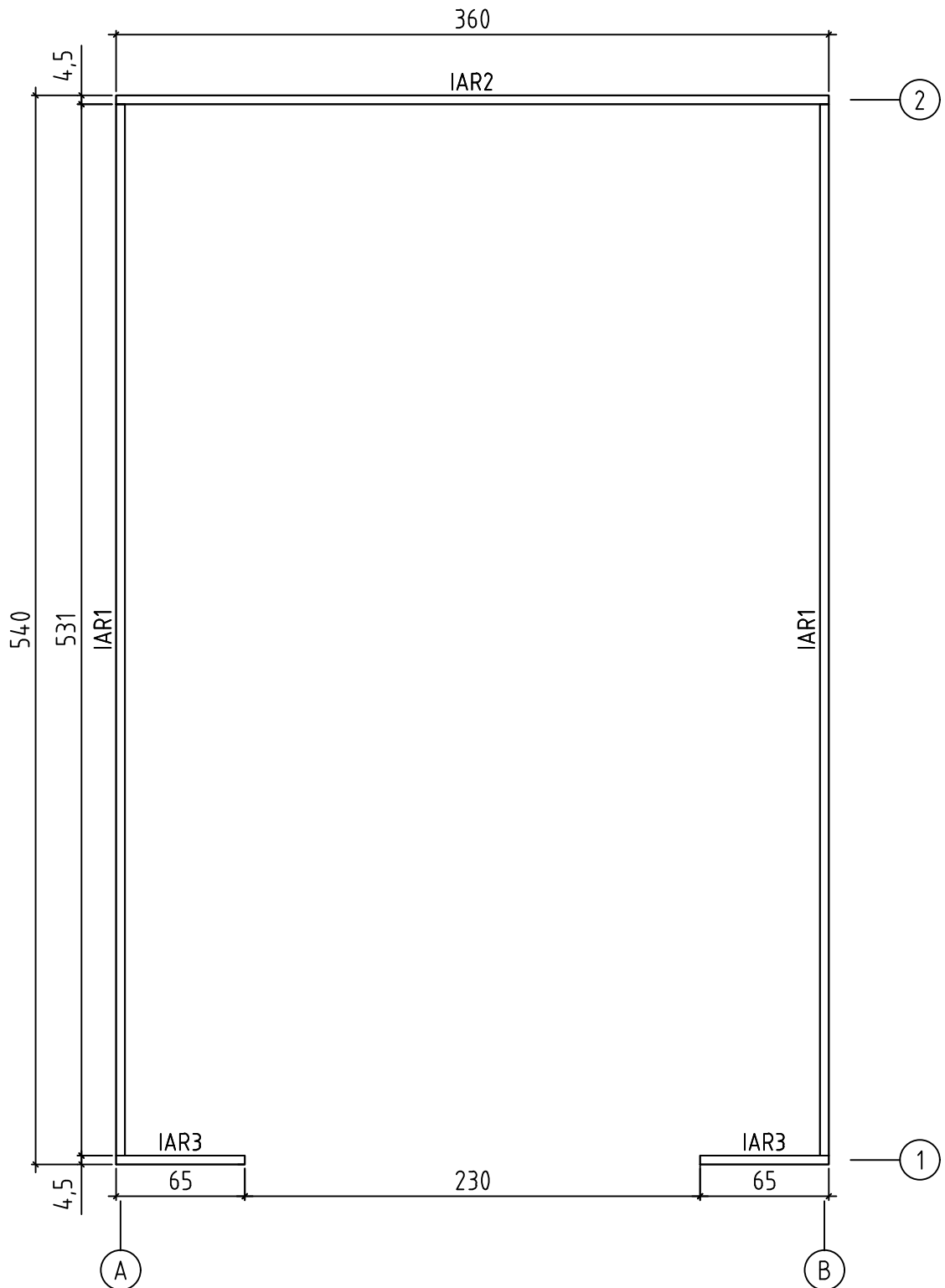

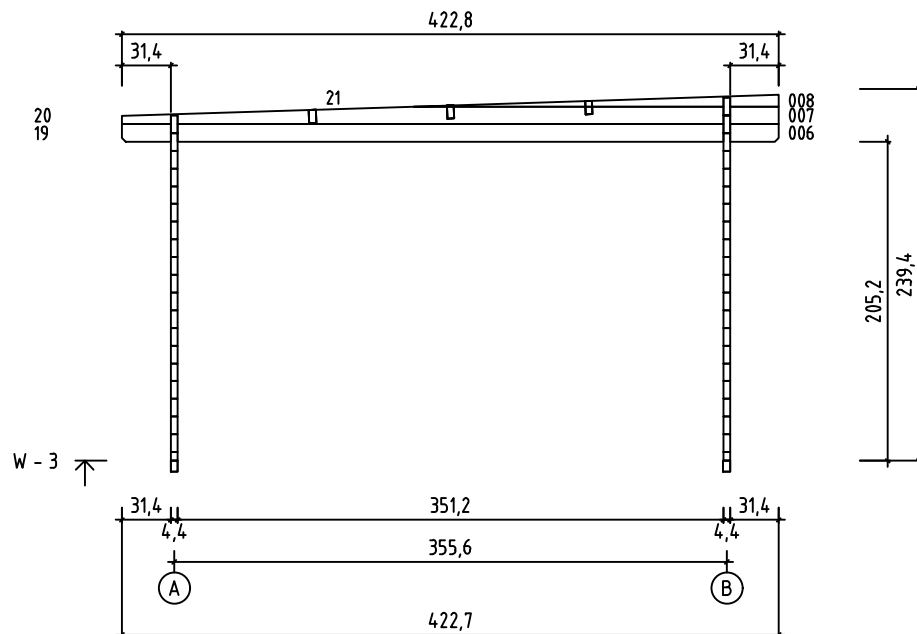
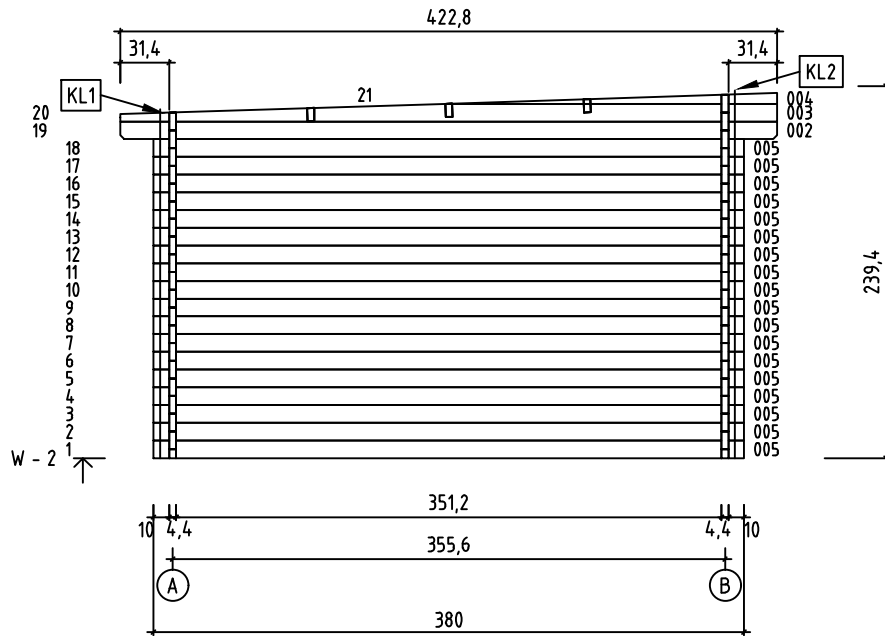
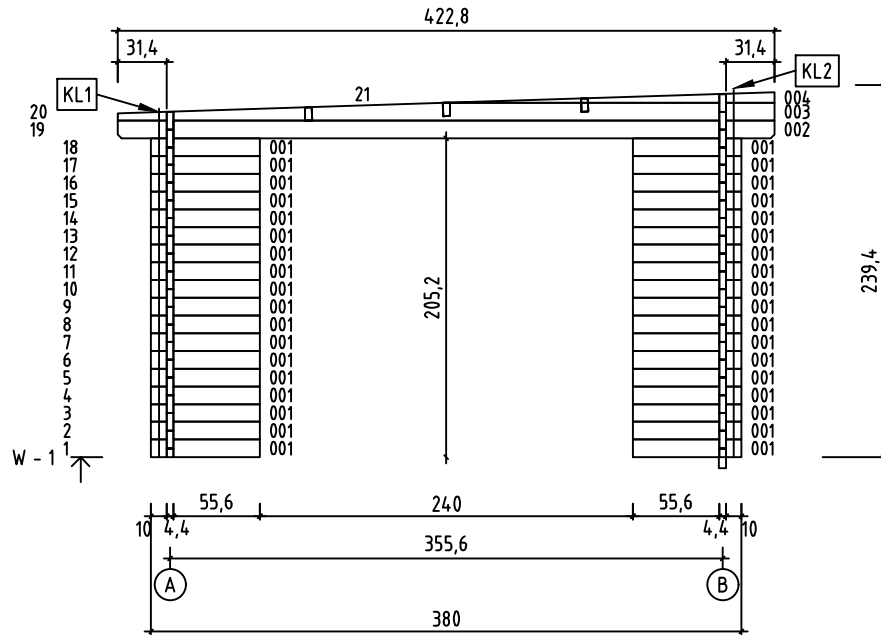





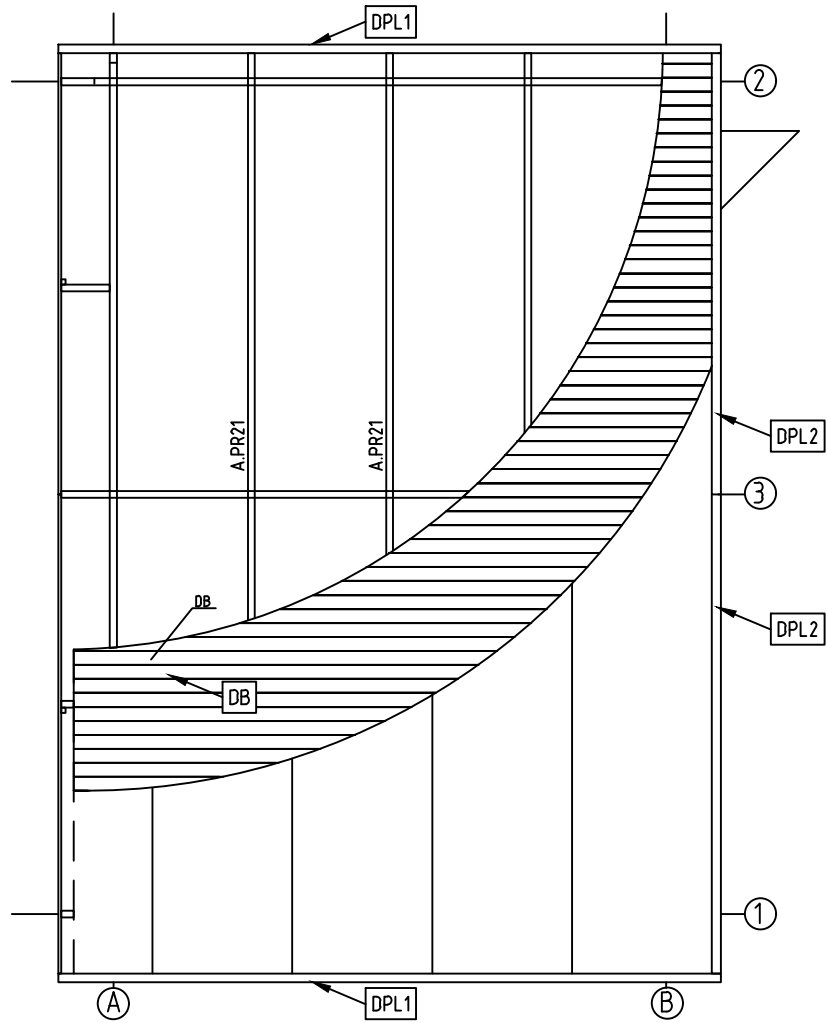



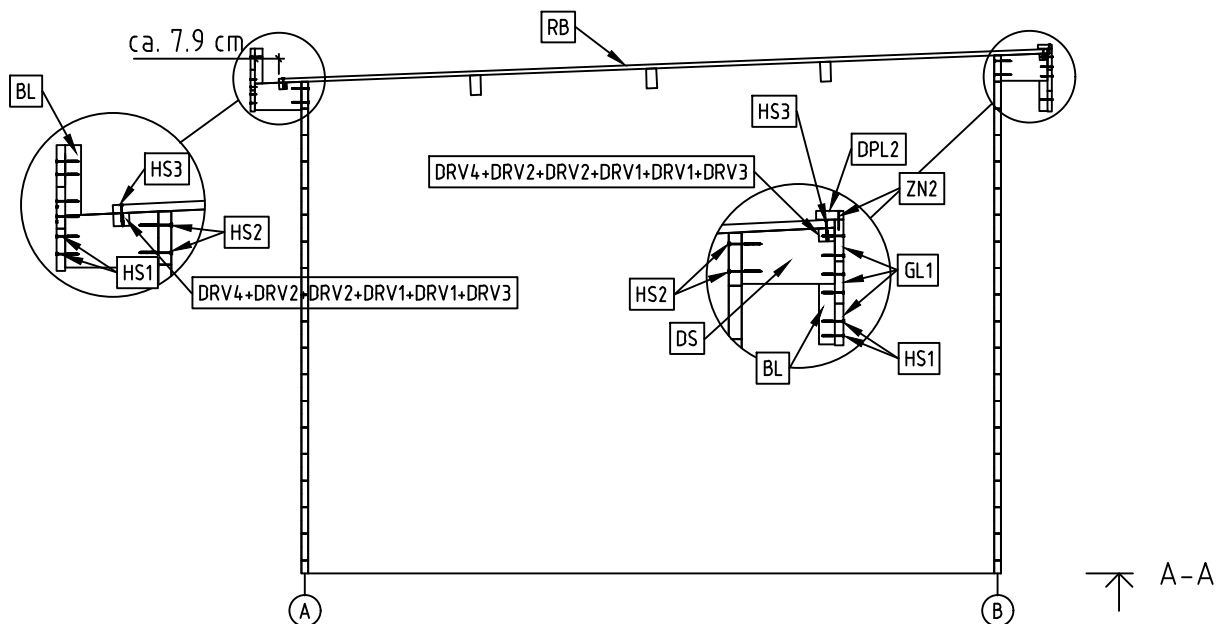

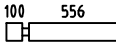
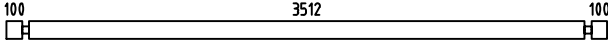
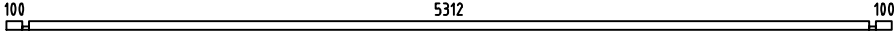
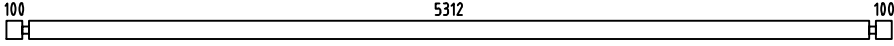
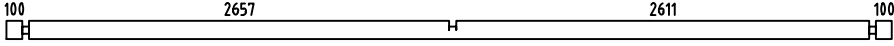
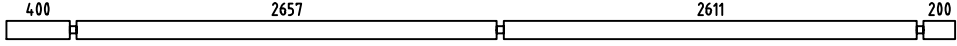
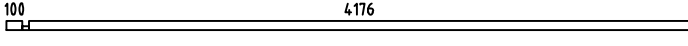

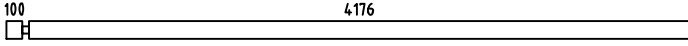



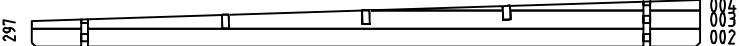
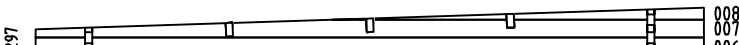
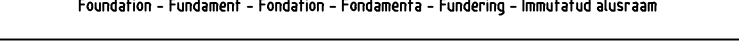
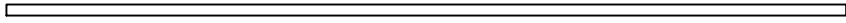
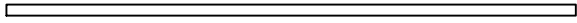
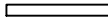
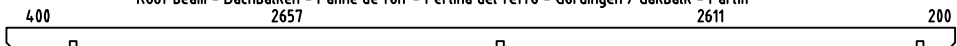



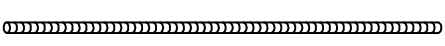
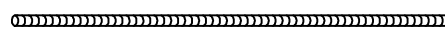
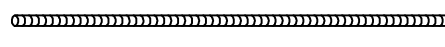

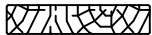
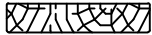
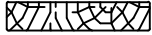



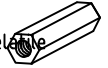

Roof plan - Dach-plan - Plan du toit - Piano del tetto - Dak plattegrond - Katuseplan



Cross section - Schnitt - Vue de coupe - Sezione trasversale - Doorsnede - Lõige

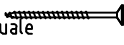

Pos	Piece list - Stückliste - Liste des pièces - Elementi - Stuklijst - Tükítabel 23.01.2018 Art.Nr. 4412193 7/8	Q.	P (mm)	L (mm)
001		36	44x114	700
005		18	44x114	3800
009		1	44x57	5600
010		17	44x114	5600
011		2	44x114	5600
012		2	44x114	6000
013		1	44x57	4320
014		1	44x57	435
015		13	44x114	4320
016		21	44x114	435
017		8	44x114	435
018		1	44x114	6000
W1-1		1		
W2-1		1		
W3-1		1		
IAR1	Foundation - Fundament - Fondation - Fondamenta - Fundering - Immutafud alusraam 	2	45x70	5310
IAR2	Foundation - Fundament - Fondation - Fondamenta - Fundering - Immutafud alusraam 	1	45x70	3600
IAR3	Foundation - Fundament - Fondation - Fondamenta - Fundering - Immutafud alusraam 	2	45x70	650
A.PR21	Roof beam - Dachbalken - Panne de toit - Perlina del tetto - Gordingen / dakbalk - Pärlin 	3	44x140	6000
DB	Roof boards - Dachbretter - Voliges - Perlina per tetto - Dakhout - Katuselaud 	67	90x18	4150
DPL2	Roofing felt fillet - Dachpappenleiste - Baguette de fixation du feutre bitumeux - Asse per fissaggio guaina bituminosa - Afdekljst asfaltpapier - Katusepapiliist 	2	18x58	2960
DPL1	Roofing felt fillet - Dachpappenleiste - Baguette de fixation du feutre bitumeux - Asse per fissaggio guaina bituminosa - Afdekljst asfaltpapier - Katusepapiliist 	2	18x58	4264
BL	Fixing slat for distance spacers - Befestigungsleiste - Renforts planches de rives - Stecca per fissare i distanziatori - Bevestigingslat afstandhouders - Viilulaua kinnitus 	4	28x34	220
KL1	Treaded rod m10 - Gewindestange m10 - Tige filetée m10 - Barra filettata passo m10 - Draadstang 10m - Keermelatt 	2		245
KL2	Treaded rod m10 - Gewindestange m10 - Tige filetée m10 - Barra filettata passo m10 - Draadstang 10m - Keermelatt 	2		365
KL1/KL2	Treaded rod m10 - Gewindestange m10 - Tige filetée m10 - Barra filettata passo m10 - Draadstang 10m - Keermelatt 	4		2000

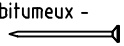
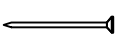

Pos	Piece list - Stückliste - Liste des pièces - Elementi - Stuklijst - Tükitalabel 23.01.2018 Art.Nr. 4412193	8/8	Q.	P (mm)	L (mm)
GL2	Fascia board - Traufbrett - Bandeau de toit - Finitura lati tetto - Gevellijst - Räästalaud		6	18x90	2877
GL3	Fascia board - Traufbrett - Bandeau de toit - Finitura lati tetto - Gevellijst - Räästalaud		6	18x90	3123
GL1	Fascia board - Traufbrett - Bandeau de toit - Finitura lati tetto - Gevellijst - Räästalaud		6	18x90	4264
DRV 1	Roof edge reinforcement - Dachrandverstärkung - Corniere de renfort de bord de toit - Rinforzo x tetto - Dakrand versterking - Räästatugevdus		4	28x34	1284
DRV 2	Roof edge reinforcement - Dachrandverstärkung - Corniere de renfort de bord de toit - Rinforzo x tetto - Dakrand versterking - Räästatugevdus		4	28x34	1306
DRV 3	Roof edge reinforcement - Dachrandverstärkung - Corniere de renfort de bord de toit - Rinforzo x tetto - Dakrand versterking - Räästatugevdus		2	28x34	200
DRV 4	Roof edge reinforcement - Dachrandverstärkung - Corniere de renfort de bord de toit - Rinforzo x tetto - Dakrand versterking - Räästatugevdus		2	28x34	400
	Support beam for gate frame - Stutzbohle für torzarge - Madrier de support du cadre de la porte basculante - Asse di supporto per il telaio della porta - Steunpaal voor poort-/ deurkozijn - Tugipuu		1	44x140	3510
DS	Distance spacers for gable moulding - Dachstützen - Supports extension toiture - Distanziatori per la modanatura del timpano - Daksteun / afstand houder - Viiluladade distantsklots		4	44x120	319
	Lengthening bolt for treaded rod - Verlängerungsmutter für gewindestange - Manchon de raccordement de tige filetée - Bullone per barra filettata passo - Extensie moer voor draadstang - Jätkumutter keermelatile		4		
	Drive nut treaded rod - Einschlagmutter für gewindestange - Écrou a frapper pour tige filetée - Dado guida per barra filettata - Aandrijfmoer / aanslagmoer voor draadstang - Löökmutter keermelatile		4		
	Nut for treaded rod - Mutter für gewindestange - Écrou pour tige filetée - Dado per barra filettata - Moer voor draadstang - Mutter keermelatil		4		
	Plain washer treaded rod - Unterlegscheibe für gewindestange - Rondelle plate pour tige filetée - Rondella per barra filettata - Sluitring voor draadeind - Seib keermelatile		4		
HS1	Screw for fascia boards - Schrauben für traufbretter - Vis pour fixation bandeau de toit - Viti x striscia del tetto - Schroef voor gevellijst - Kruvi räästalaualae		120	3.5x50	
HS3	Screw for roof edge reinforcement - Schrauben für dachrandverstärkung - Vis pour fixation corniere renfort de bord de toit - Viti x rinforzo bordo tetto - Schroef voor dakrand versterking - Kruvi räästatugevdusele		32	4x40	
	Screw for roof beams - Schrauben für dachbalken - Vis pour fixation pannes de toit - Viti per perline del tetto - Schroef voor gordingen / dakbalken - Kruvi pärlinitele		15	5x120	
	Screw for 1. wall beam - Schraube für 1. bohlenreihe - Vis de fixations 1ere rangée de madriers avec poutrelles de fondations - Vite fissaggio alle fondamenta - Schroef voor 1 wandbalk - Kruvi poollauale		8	5x90	
	Screw for foundation - Schrauben zur befestigung fundament - Vis de fixations des poutrelles de fondations - Viti x fondamenta - Schroef voor fundering - Kruvi alusraamile		4	5x90	
HS2	Screw for fixing gable moulding distance spacers to the wall - Schrauben für dachstützen - Vis de supports extension toiture - Viti x fissaggio fascioni - Schroef voor bevestiging gevelpunt tof wand - Kruvi viiluladade distantsklotsi kinnitamiseks seinale		8	5x90	
	Hammer block - Schlagholz - Calle de frappe - Blocco di legno da usare come cuscinetto quando si usa il martello - Slagklos - Löögiklots		1		
ZN2	Zn nail for roofing felt fillet - Zn nägel für dachpappenleiste - Pointe pour baguette de fixation feutre bitumeux - Chiodi x carta bituminosa x tetto - Spijker(nagel) voor asfaltpapier afdekljst - Papiilistunael		33	2x40	
	Zn nail for roof - Zn nägel für dachbretter - Pointe pour fixation voliges de toit - Chiodi x perline tetto - Spijker(nagel) voor dakhout - Nael katuselauale		352	2x50	
	Window - Fenster - Fenetre - Finestra - Raam - Aken	1500x410 AK.1.100.TMM0.k MGC	2		
	Door - Tür - Porte - Porte - Deur - Uks	835x1957 UK.3.030.TMVP.MM MGC	1		

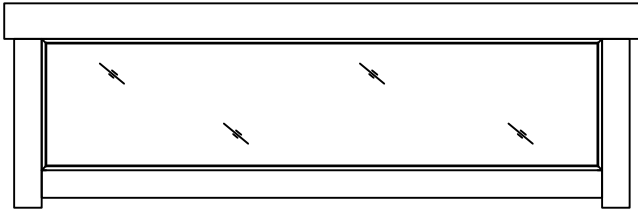

Pos	16.11.2017 Piece list - Stückliste - Liste des pièces - Elementi - Stuklijst - Tükitabel 1500x410 AK.1.100.TMM0.k MGC 1/1	Q	P (mm)	L (mm)
-----	--	---	-----------	-----------

Glass size - Glasgröße - Taille de la vitre - Misura del vetro - Glas afmeting - Klaasi mõõt: 1420x330 mm

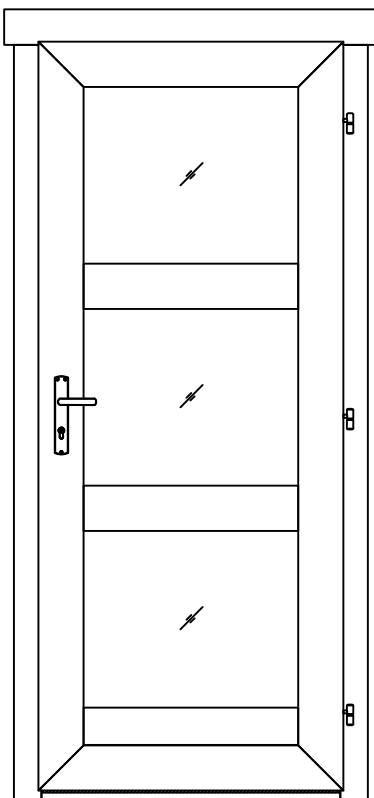
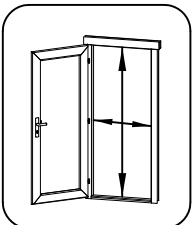
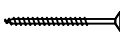
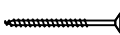

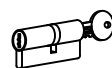
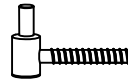
Pos	16.11.2017 Piece list - Stückliste - Liste des pièces - Elementi - Stuklijst - Tükítabel 835x1957 UK.3.030.TMVP.MM MGC 1/1	Q	P (mm)	L (mm)
	<p>Glass size - Glasgröße - Taille de la vitre - Misura del vetro - Glas afmeting - Klaasi mõõt: 561x465 mm</p>   <p>735x1873 mm</p>			
HS25	<p>Screw for doorstep - Schrauben für swelle - Vis pour fixation barre de seuil - Vite per soglia della porta - Schroef voor deurdorpel - Kruvi lävepakule</p> 	2	4.5x65	
HS16	<p>Screw for door jamb - Schraube für türrahmen - Vis de fixation partie haute avec montants du cadre de porte - Viti x fissaggio montanti porte - Schroef voor deurkozijn - Kruvi ukse lengile</p> 	4	5x90	
TL4	<p>Door handle fittings - Türgriff - Poignee de porte - Maniglie - Deurhendel / klink - Ukse käepide</p> 	1		
TL5	<p>Set of door lock covers - Schlossblenden - Set de garnitures de porte - Copertura serrature - Slot sluitplaat set - Ukse lukuplaat</p> 	1		
	<p>Cylinder lock - Zylinderschloss - Barillet de porte - Serratura - Cylinder slot - Ukse lukusüdamik</p> 	1	30x35	
	<p>Male bolt hinge for door - Türband - Partie male de paumelle de porte - Cerniera anube x porta - Scharnier bout - Ukse polthing isane</p> 	3		