

Bodo
Art. Nr. 4021000
1/9

Groundplan - Grundplan - Plan de masse - Planimetria - Plattegrond - Põhiplan

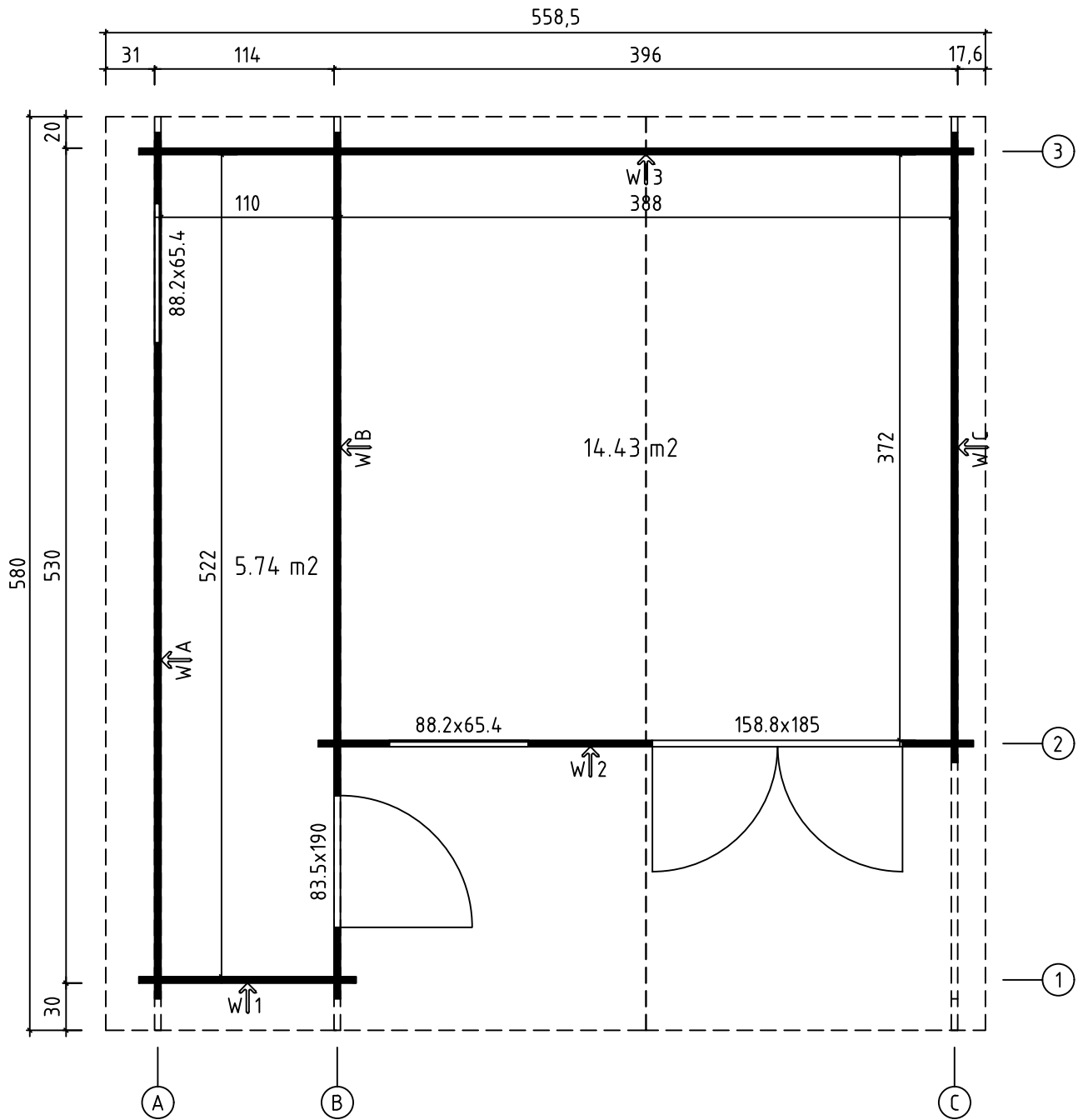

Art. Nr. 4021000

Foundation - Fundament - Fondation - Fondamenta - Fundering - Immutatud alusraam

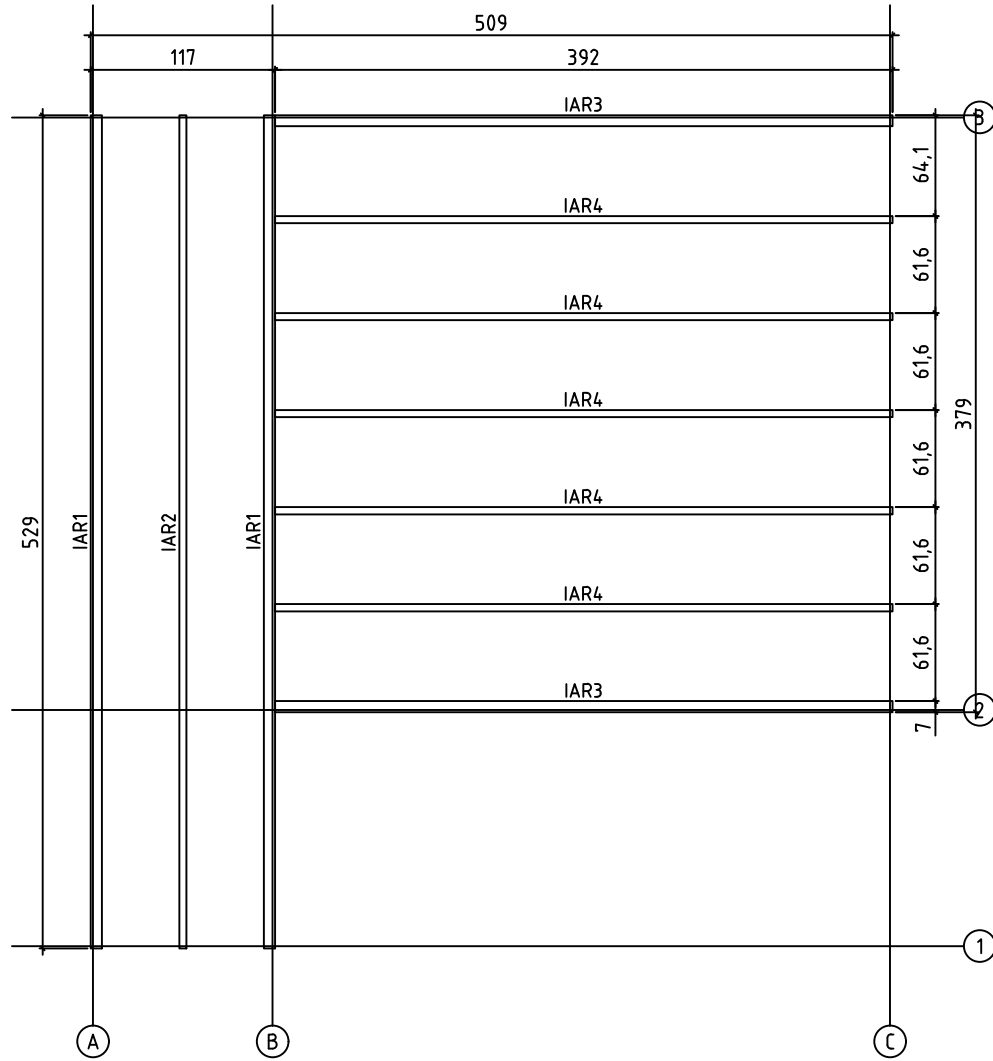



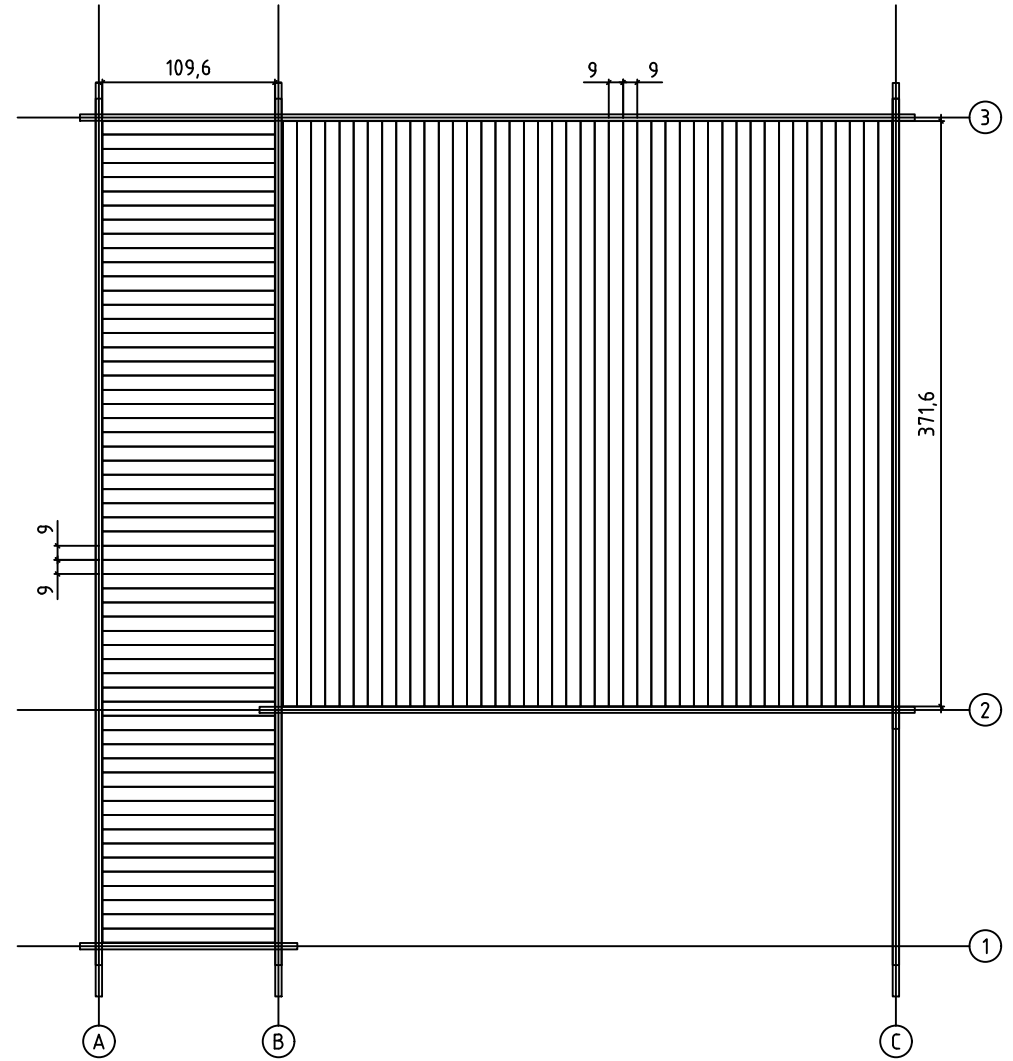

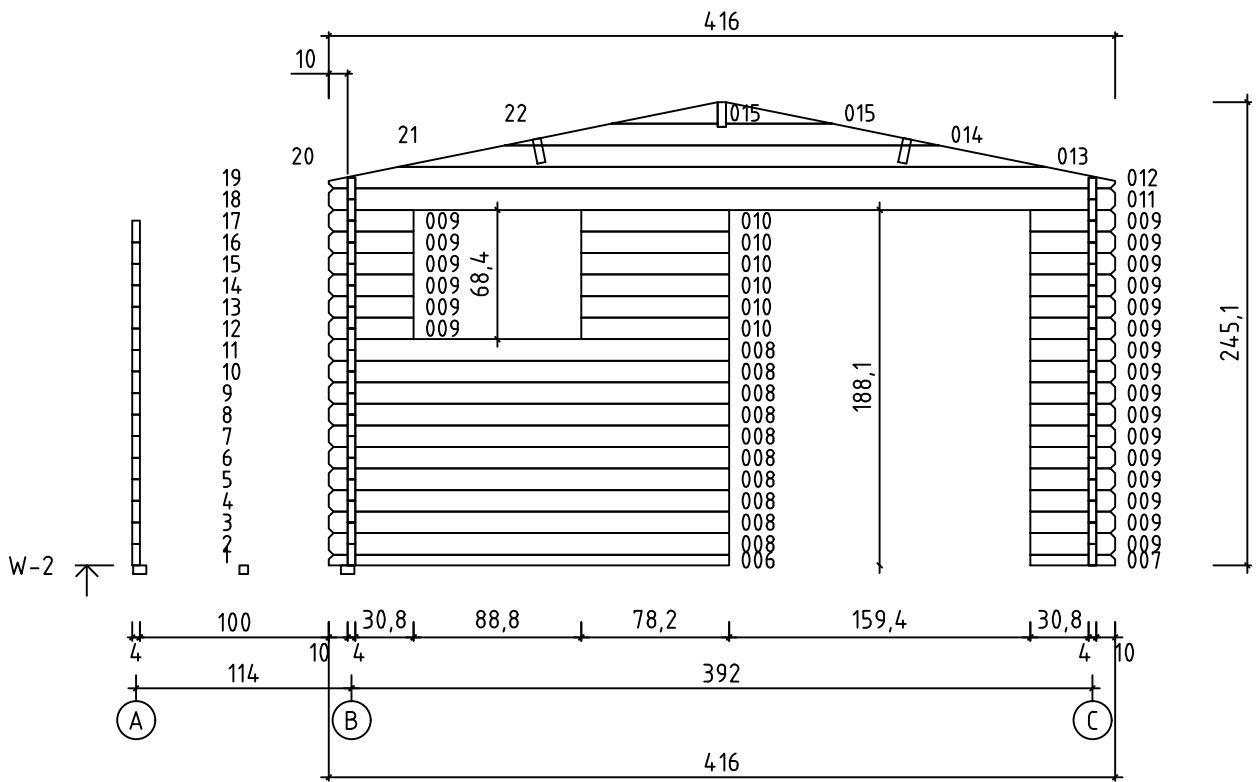
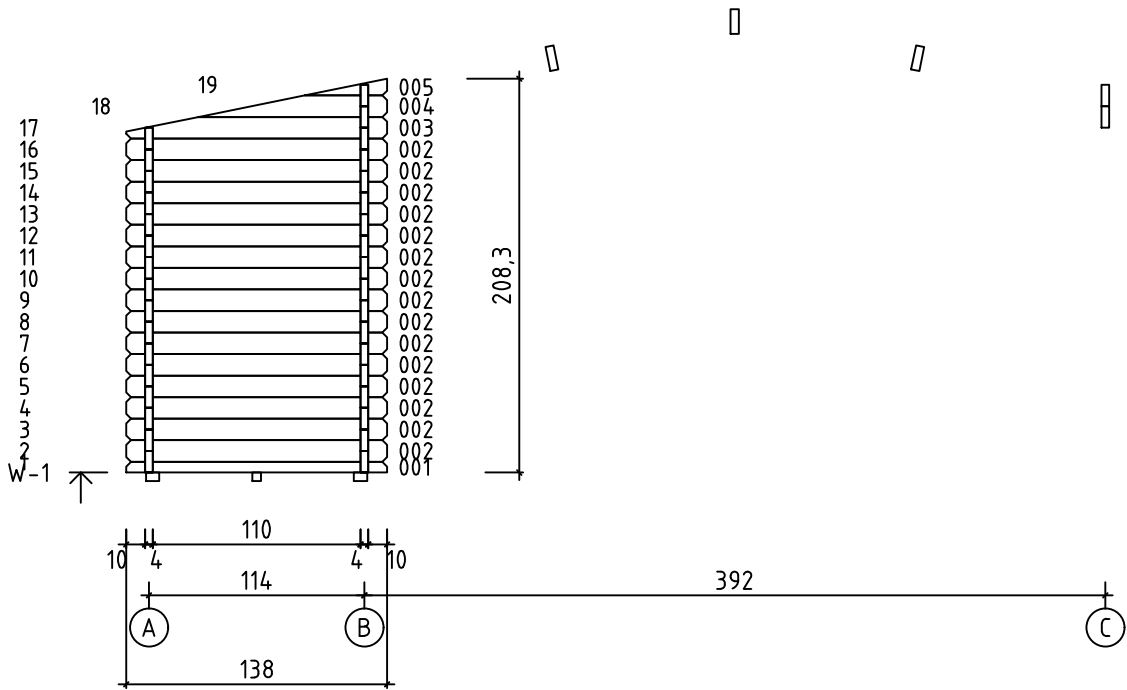

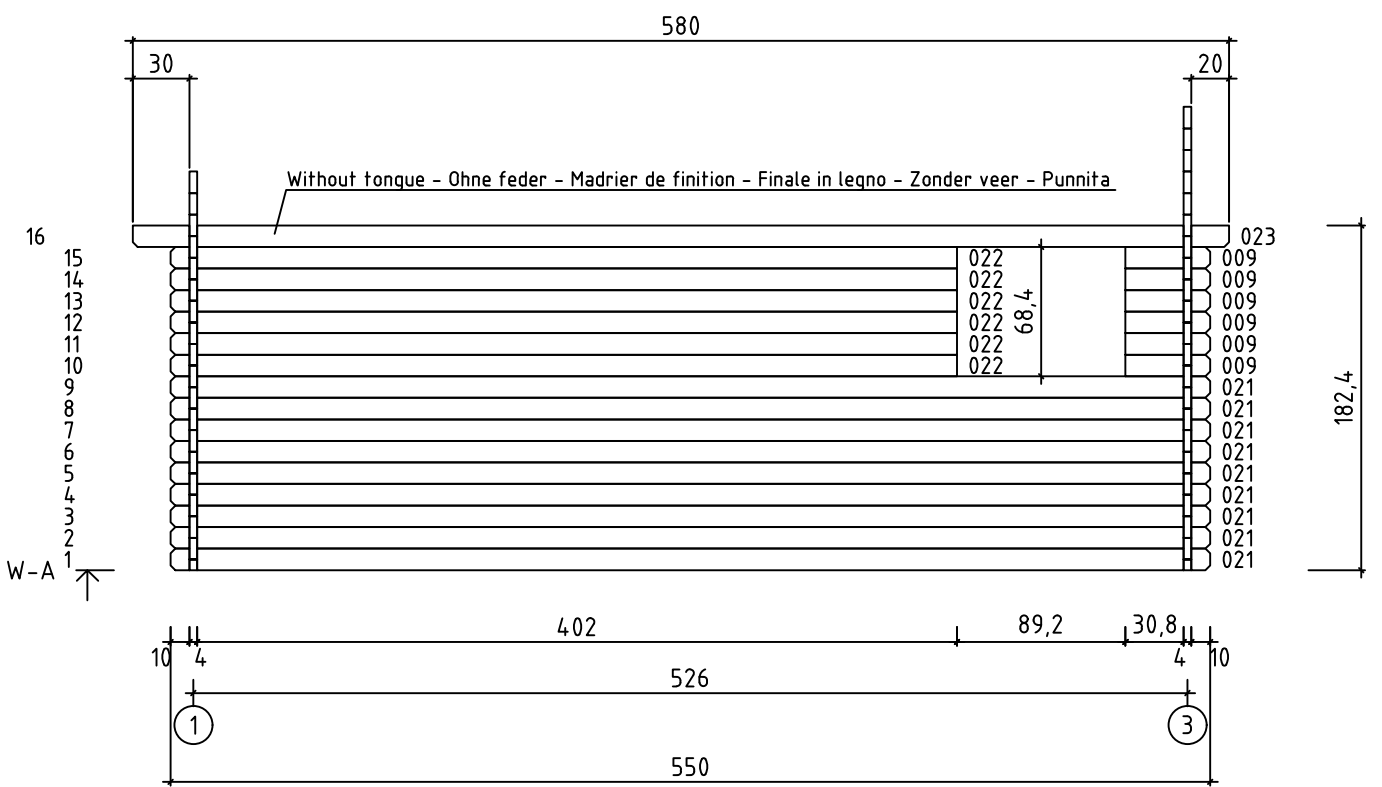
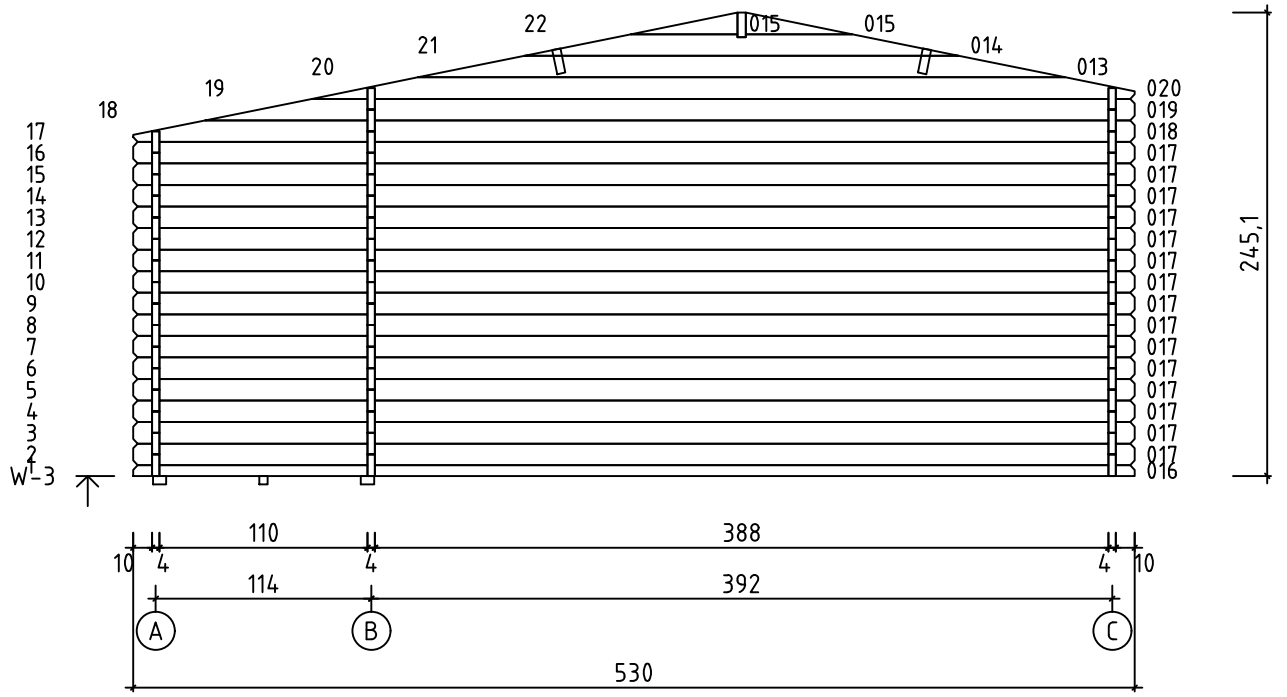
Floor boards - Fussbodenbretter - Plan pose plancher - Pavimento - Vloerhout - Põrandalaudis

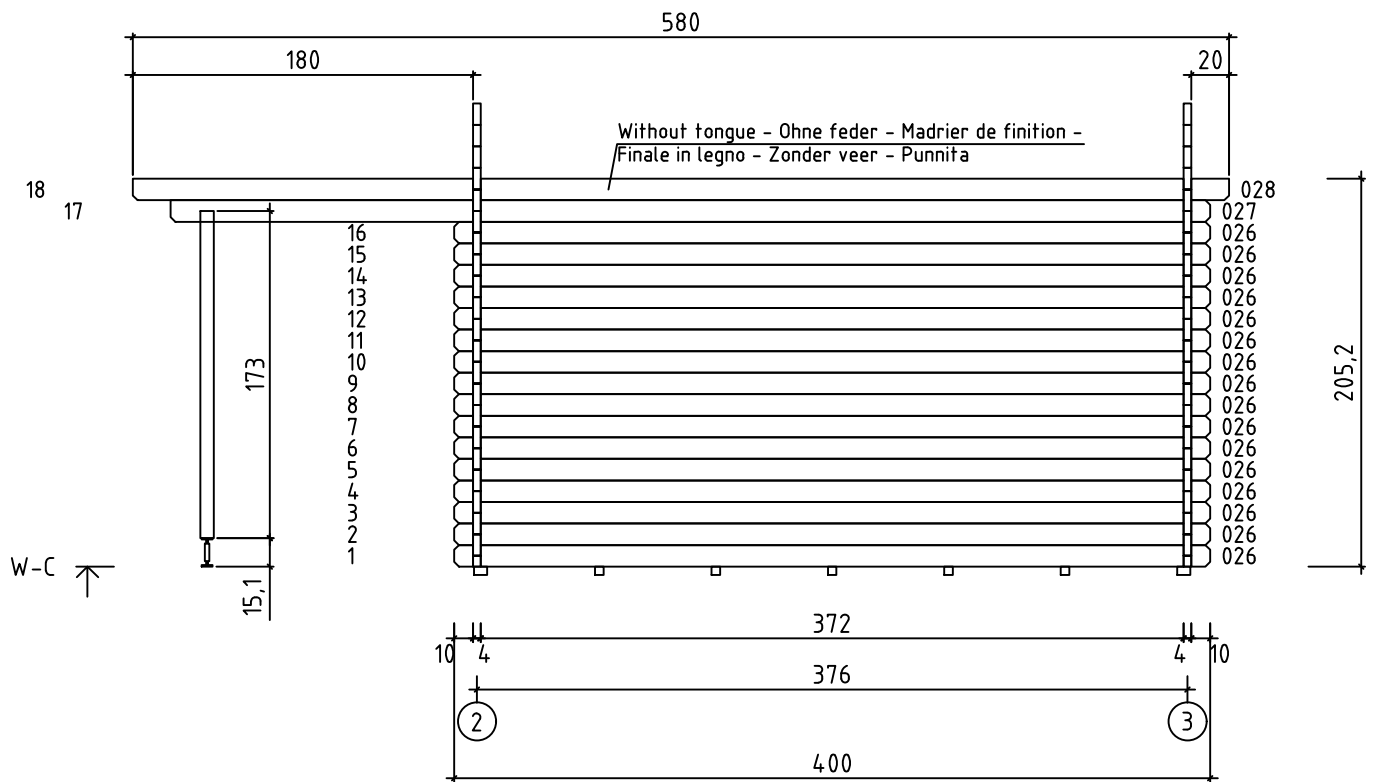
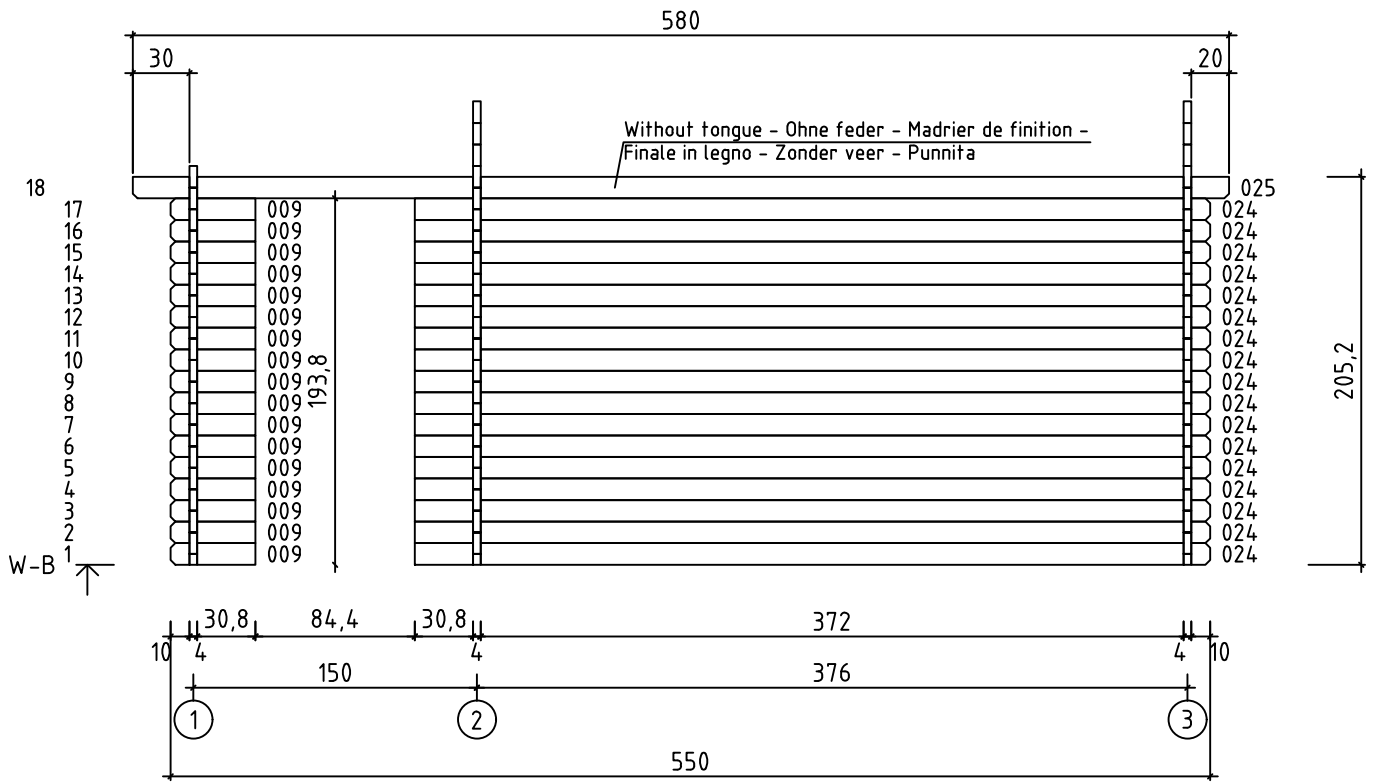

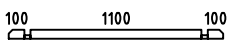
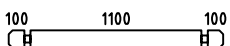
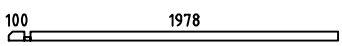

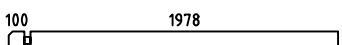

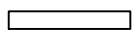
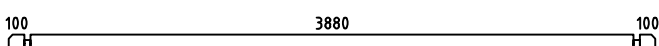
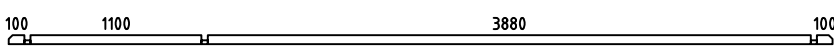
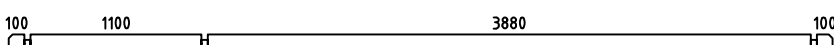
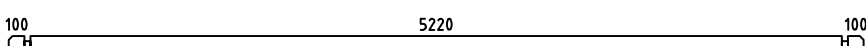
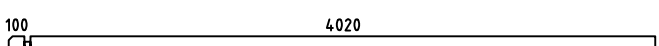
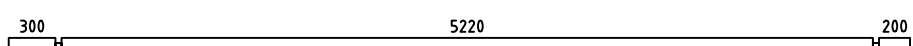
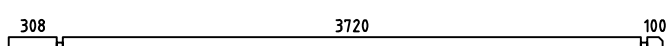
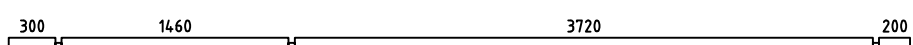
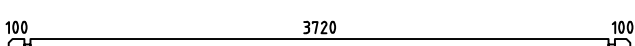
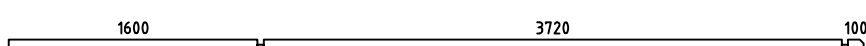

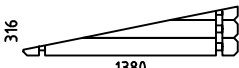
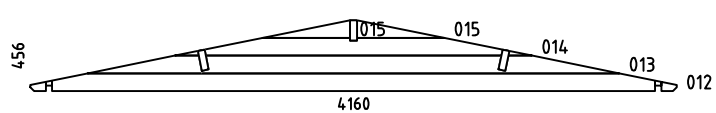
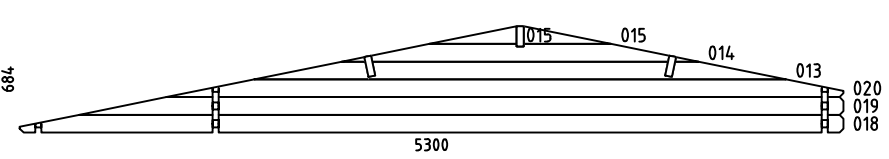



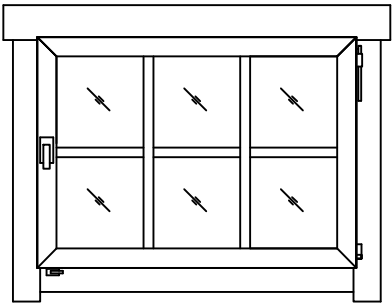
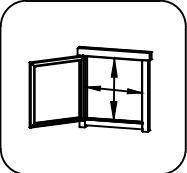
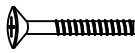
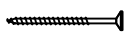

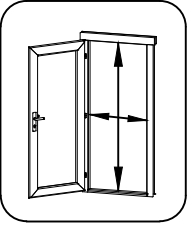
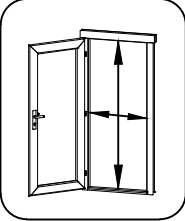
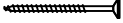
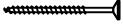
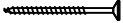

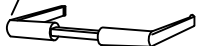

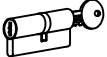
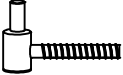
Pos	09.04.2019 Piece list - Stückliste - Liste des pièces - Elementi - Stuklijst - Tükítabel Art. Nr. 4021000 7/9	Q	P (mm)	L (mm)
001		1	40x57	1380
002		15	40x114	1380
006		1	40x57	2118
007		1	40x57	448
008		10	40x114	2118
009		45	40x114	448
010		6	40x114	782
011		1	40x114	4160
016		1	40x57	5300
017		15	40x114	5300
021		9	40x114	5500
022		6	40x114	4160
023		1	40x114	5800
024		17	40x114	4208
025		1	40x114	5800
026		16	40x114	4000
027		1	40x114	5500
028		1	40x114	5800
W1-1		1		
W2-1		1		
W3-1		1		

Pos	09.04.2019 Piece list - Stückliste - Liste des pièces - Elementi - Stuklijst - Tükitalabel Art. Nr. 4021000 8/9	Q	P (mm)	L (mm)
IAR1	Foundation - Fundament - Fondation - Fondamenta - Fundering - Immutatud alusraam 	2	70x45	5290
IAR3	Foundation - Fundament - Fondation - Fondamenta - Fundering - Immutatud alusraam 	2	70x45	3920
IAR2	Foundation - Fundament - Fondation - Fondamenta - Fundering - Immutatud alusraam 	1	45x45	5290
IAR4	Foundation - Fundament - Fondation - Fondamenta - Fundering - Immutatud alusraam 	5	45x45	3920
A-PR1	Roof beam - Dachbalken - Panne de toit - Perlina del tetto - Gordingen / dakbalk - Pärilin 1800 3720 200 	3	44x140	5800
	Floor boards - Fussbodenbretter - Lame de plancher - Pavimento - Vloerhout - Põrandalaud 	44	90x18	3716
	Floor boards - Fussbodenbretter - Lame de plancher - Pavimento - Vloerhout - Põrandalaud 	58	90x18	1096
	Roof boards - Dachbretter - Voliges - Perlina per tetto - Dakhout - Katuselaud 	65	90x18	3500
	Roof boards - Dachbretter - Voliges - Perlina per tetto - Dakhout - Katuselaud 	65	90x18	2200
	Floor fillet - Fussbodenleiste - Corniere de finition du plancher - Finitura per pavimento (battisco pa) - Vloerafwerklijst - Põrandaliist 		18x18	27.81
	Roofing felt fillet - Dachpappenleiste - Baguette de fixation du feutre bitumeux - Asse per fissaggio guaina bituminosa - Afdekljst asfaltpapier - Katusepapiiist 	2	15x45	2250
	Roofing felt fillet - Dachpappenleiste - Baguette de fixation du feutre bitumeux - Asse per fissaggio guaina bituminosa - Afdekljst asfaltpapier - Katusepapiiist 	2	15x45	3550
	Post - Pfosten - Poteau - Piede registrabile - Stijl - Post 	1	70x70	1730
TB-1	Fascia board - Traufbrett - Bandeau de toit - Finitura lati tetto - Gevellijst - Räästalaud 	4	18x58	2900
DRV-1	Roof edge reinforcement - Dachrandverstärkung - Corniere de renfort de bord de toit - Rinforzo x tetto - Dakrand versterking - Räästatugevdus 	4	15x45	2900
KFS-1	Storm protection - Sturmleiste - Latte anti-tempete - Protezione anti vento - Stormverankering / beveiliging - Tormikinnitusliist 	6	22x45	2050
	Gable moulding - Giebelleiste - Planche de rive - Finitura per frontale e retro del tetto - Gevellijst - Viilulaud 	2	18x120	2250
	Gable moulding - Giebelleiste - Planche de rive - Finitura per frontale e retro del tetto - Gevellijst - Viilulaud 	2	18x120	3550
HS8	Screw for gable segment - Schrauben für deckblatt - Vis pour fixation losange de finition - Viti x frontali tetto - Schroef voor gevelpunt segment - Kruvi rombile 	4	3.5x35	
HS9	Screw for gable moulding - Schrauben für giebelleiste - Vis pour fixation planche de rive - Vite per fissare finiture davanti e dietro del tetto - Schroef voor gevellijst - Kruvi viilulauale 	28	3.5x50	
HS4	Screw for roof edge reinforcement - Schrauben für dachrandverstärkung - Vis pour fixation corniere renfort de bord de toit - Viti x rinforzo bordo tetto - Schroef voor dakrand versterking - Kruvi räästatugevdusele 	28	3x30	
HS12	Screw for fascia boards - Schrauben für traufbretter - Vis pour fixation bandeau de toit - Viti x striscia del tetto - Schroef voor gevellijst - Kruvi räästalauale 	28	4x40	
HS13	Screw for post - Schrauben für pfosten - Vis de fixation des poteaux - Viti per inviare - Schroef voor stijlen - Kruvi postale 	2	4x60	

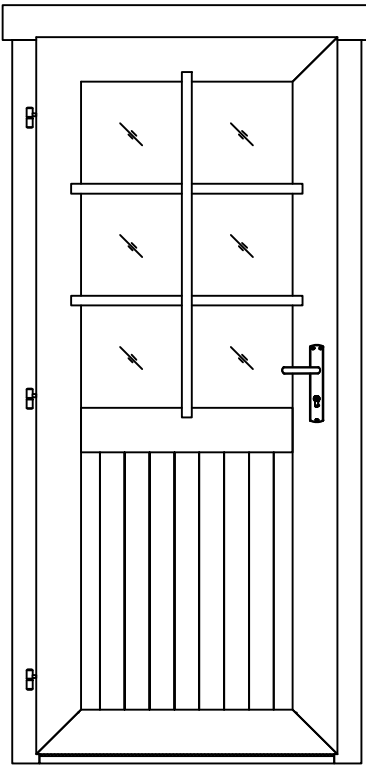
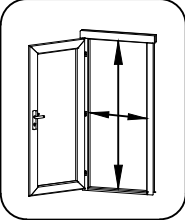
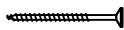
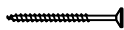
Pos	08.04.2019 Piece list - Stückliste - Liste des pièces - Elementi - Stuklijst - Tükítabel 882x654 AK.1.106.SSP.e SGC	1/1	Q	P (mm)	L (mm)
	<p data-bbox="263 152 1284 183">Glass size - Glasgröße - Taille de la vitre - Misura del vetro - Glas afmeting - Klaasi mõõt: 510x738 mm</p> <div data-bbox="657 241 1050 542" style="text-align: center;">  </div> <div data-bbox="1337 152 1524 324" style="text-align: right;">  <p data-bbox="1369 347 1492 376">782x554 mm</p> </div>				
FS1	Window handle fittings - Fenstergriff - Poignée de fenetre - Maniglia c/ferramenta - Raamhendel -/grendel -/klink - Aknalink		1		
FSP	Bolt for window handle fittings - Bolzen für fenstergriff beschlag - Vis pour fixation poignée de fenetre - Bullone x apertura manuale finestra - Schroef voor raamhendel - Akna käepideme polt		2		
HS1	Screw for georgian bars - Schraube für sprossen - Vis pour croisillons - Viti per unire la griglia georgiana della finestra - Schroeven voor raamverdeling - Kruvi akna petfeliistule		6	2.5x20	

Pos	8.11.2018	Piece list - Stückliste - Liste des pièces - Elementi - Stuklijst - Tükítabel 1588x1850 TUK.1.108.SVP.MMa SGC	1/1	Q	P (mm)	L (mm)
		Glass size - Glasgröße - Taille de la vitre - Misura del vetro - Glas afmeting - Klaasi mõõt: 561x1486 mm			 1488x1768 mm	
						
HS1	Screw for georgian bars - Schraube für sprossen - Vis pour croisillons - Viti per unire la griglia georgiana della finestra - Schroeven voor raamverdeling - Kruvi ukse peffeliistule		16	2.5x20		
HS4	Screw for door fillet - Schraube zur befestigung türleiste - Vis pour fixation baguette d'arret de porte - Viti per massellino della porta - Schroef voor deurlijst - Kruvi ukse kokkuvaltšiliistule		5	3x30		
HS16	Screw for door jamb - Schraube für türrahmen - Vis de fixation partie haute avec montants du cadre de porte - Viti x fissaggio montanti porte - Schroef voor deurkozijn - Kruvi ukse lengile		4	5x90		
HS25	Screw for doorstep - Schrauben für swelle - Vis pour fixation barre de seuil - Vite per soglia della porta - Schroef voor deurdorpel - Kruvi lävepakule		3	4.5x65		
TL4	Door handle fittings - Türgriff - Poignee de porte - Maniglie - Deurhendel / klink - Ukse käepide		1			
TL5	Set of door lock covers - Schlossblenden - Set de garnitures de porte - Copertura serrature - Slot sluitplaat set - Ukse lukuplaat		1			
	Cylinder lock - Zylinderschloss - Barillet de porte - Serratura - Cylinder slot - Ukse lukusüdamik		1	30x35		
	Male bolt hinge for door - Türband - Partie male de paumelle de porte - Cerniera anube x porta - Scharnier bout - Ukse polthing isane		6			
	Striker for barrel bolt - Hülse für grendelriegel - Gache au sol du targette - Boccola per fermo della porta - Huls voor vergrendelingsschuif - Vasturaud ukse servariivile		2			

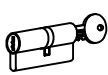
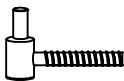
Pos	09.04.2019 Piece list - Stückliste - Liste des pièces - Elementi - Stuklijst - Tükítabel 835x1900 UK.2.056.SVV.MMd SGC	1/1	Q	P (mm)	L (mm)
	<p>Glass size - Glasgröße - Taille de la vitre - Misura del vetro - Glas afmeting - Klaasi mõõt: 561x855 mm</p>   <p>735x1818 mm</p>				
HS1	Screw for georgian bars - Schraube für sprossen - Vis pour croisillons - Viti per unire la griglia georgiana della finestra - Schroeven voor raamverdeling - Kruvi ukse petteliistule		6	2.5x20	
HS16	Screw for door jamb - Schraube für Türrahmen - Vis de fixation partie haute avec montants du cadre de porte - Viti x fissaggio montanti porte - Schroef voor deurkozijn - Kruvi ukse lengile		4	5x90	
HS25	Screw for doorstep - Schrauben für swelle - Vis pour fixation barre de seuil - Vite per soglia della porta - Schroef voor deurdorpel - Kruvi lävepakule		2	4.5x65	
TL4	Door handle fittings - Türgriff - Poignée de porte - Maniglie - Deurhendel / klink - Ukse käepide VU		1		
TL5	Set of door lock covers - Schlossblenden - Set de garnitures de porte - Copertura serrature - Slot sluitplaat set - Ukse lukuplaat		1		
	Cylinder lock - Zylinderschloss - Barillet de porte - Serratura - Cylinder slot - Ukse lukusüdamik		1	30x35	
	Male bolt hinge for door - Türband - Partie male de paumelle de porte - Cerniera anube x porta - Scharnier bout - Ukse polthing isane		3		