

Baltic 16 Hurmi // 170/19

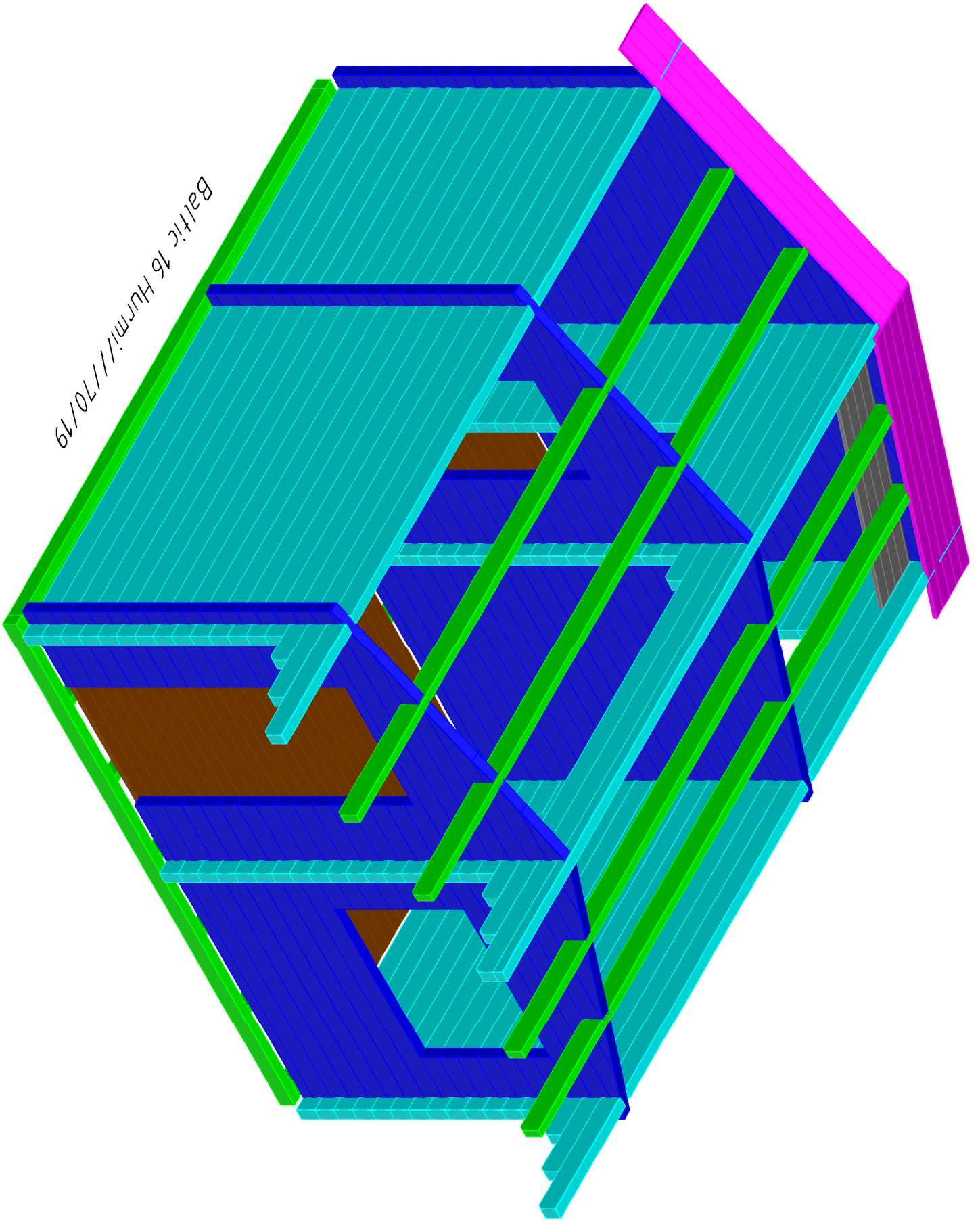

Grundplan

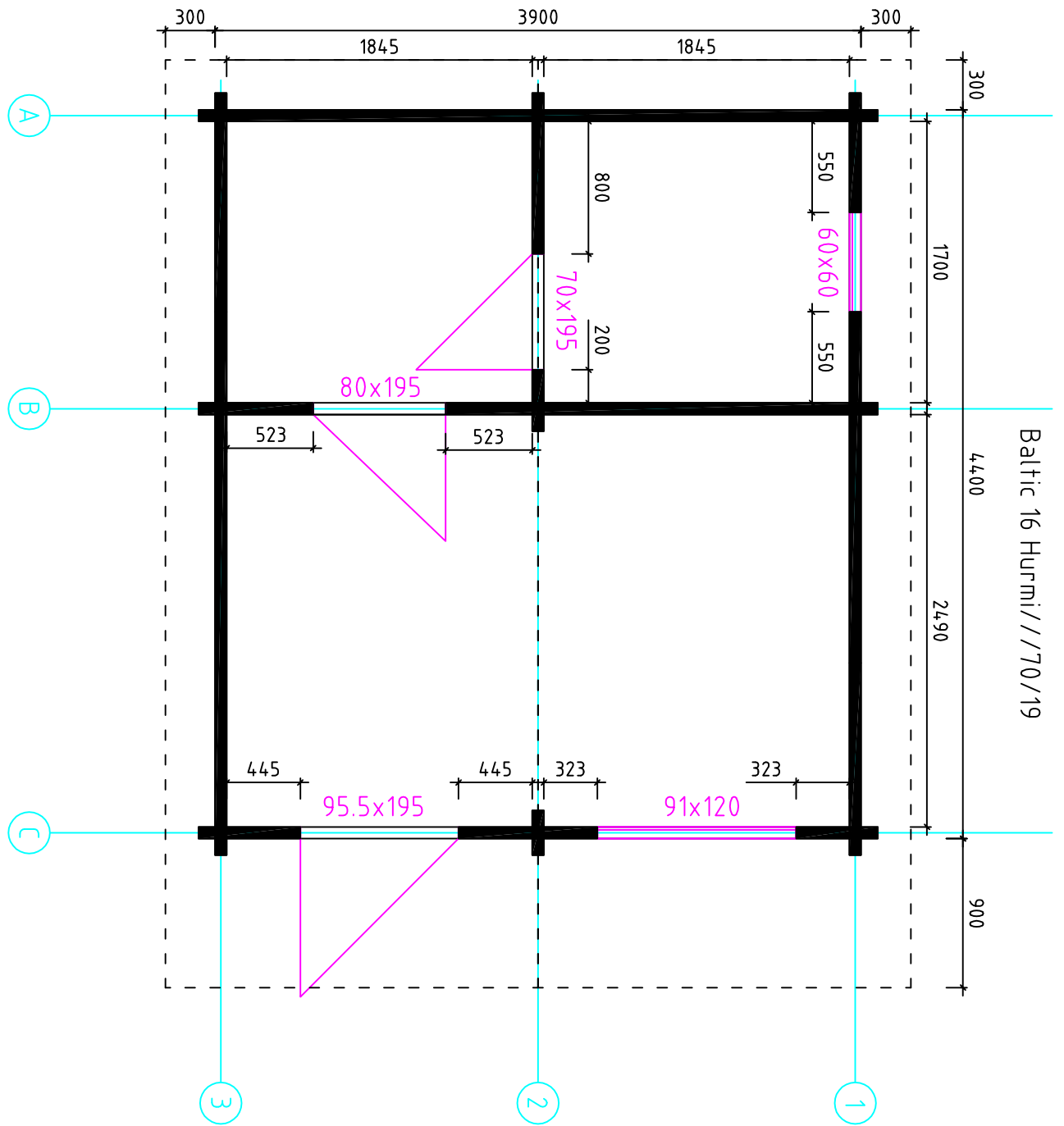

Baltic 16 Hurmi//70/19

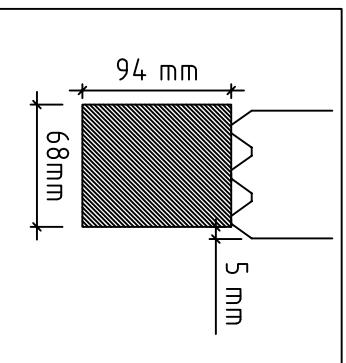
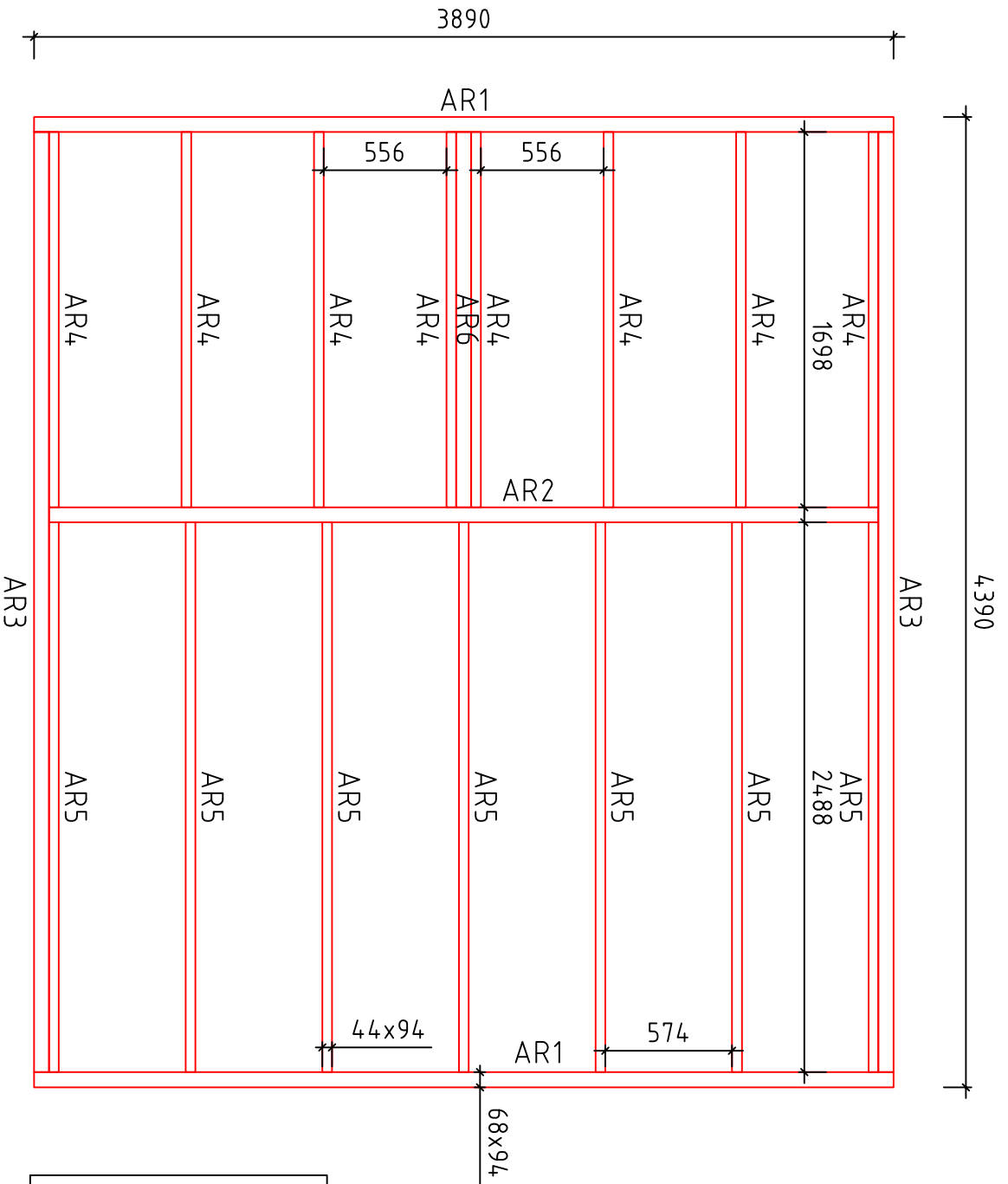



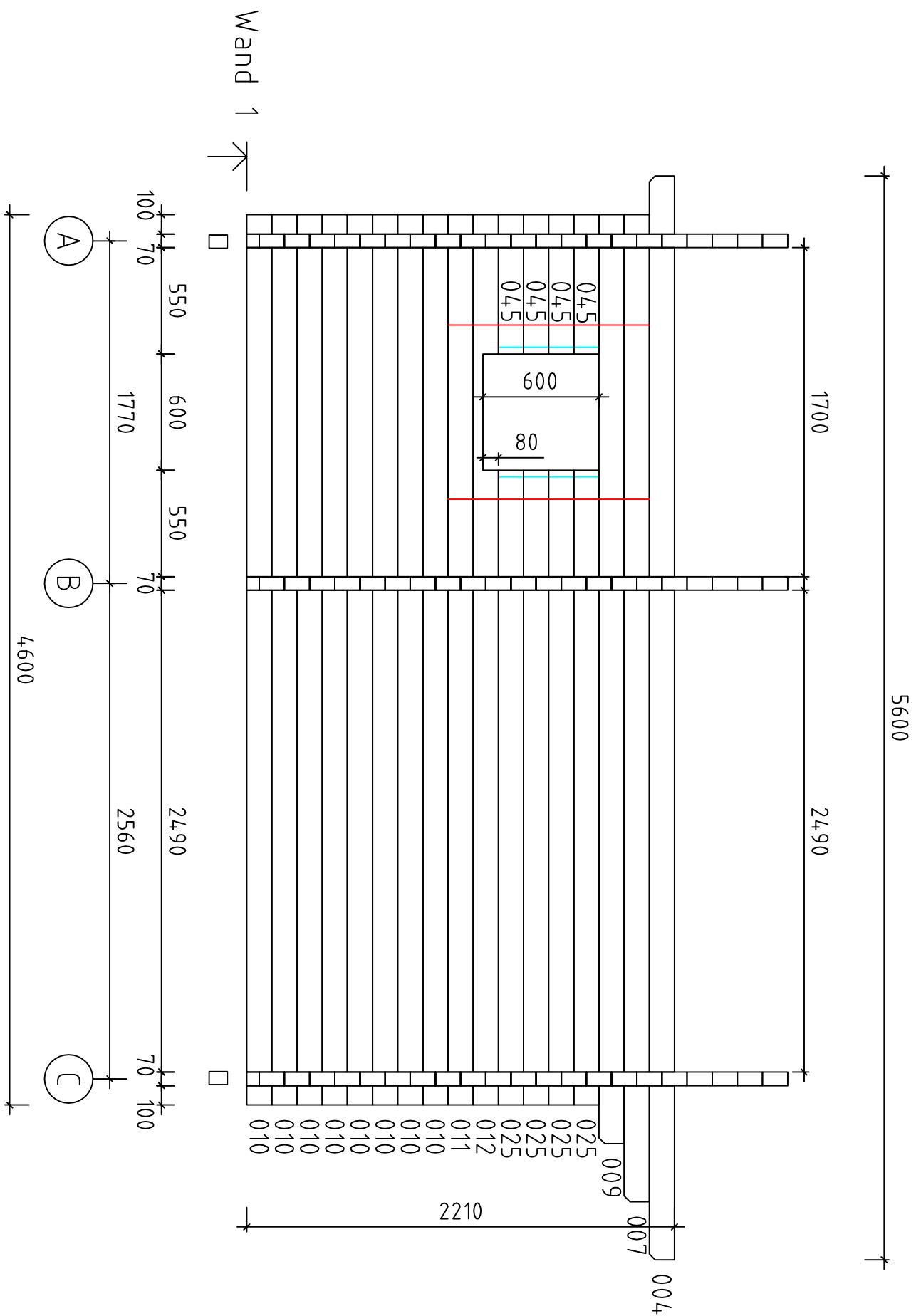

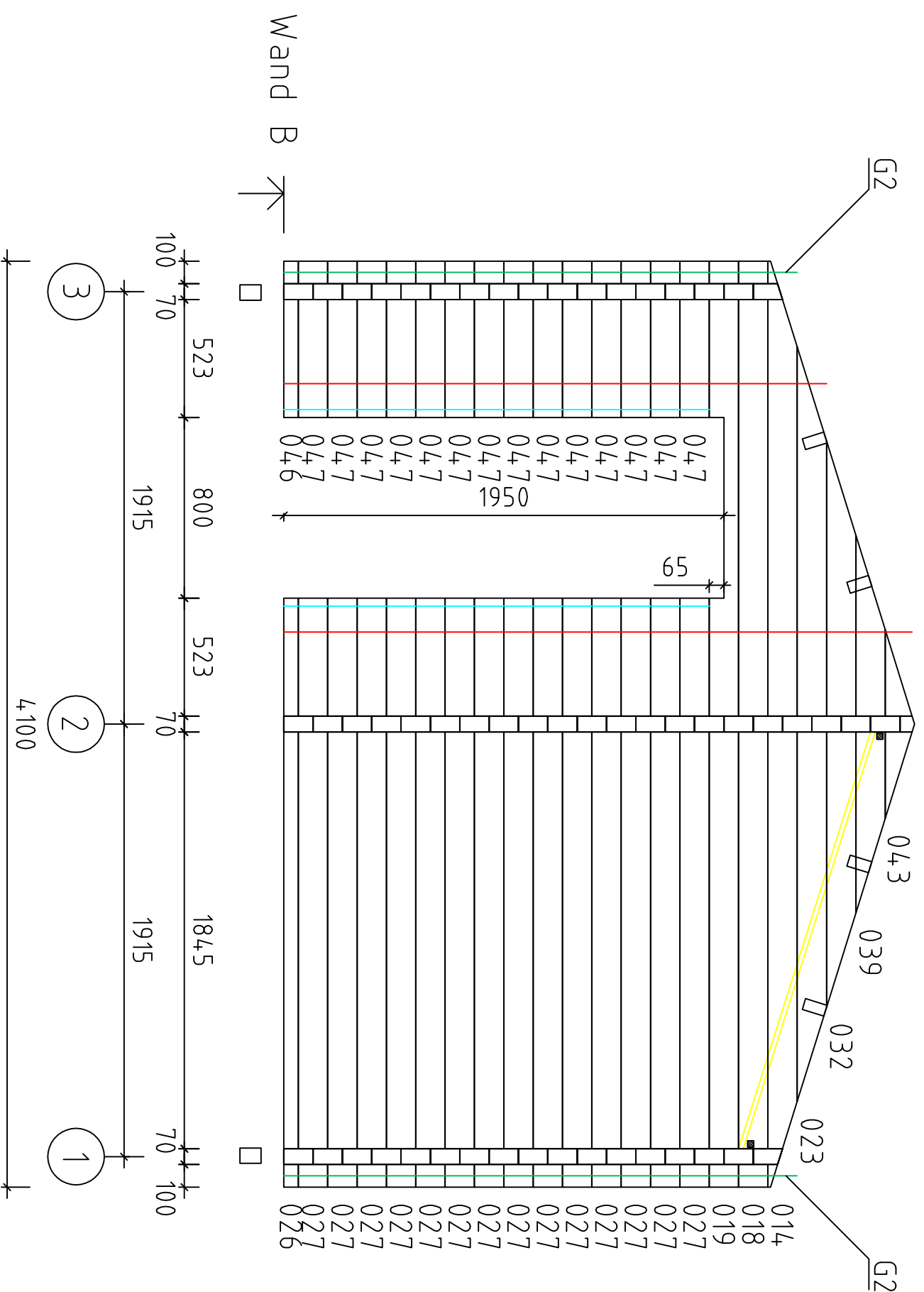

Fundament



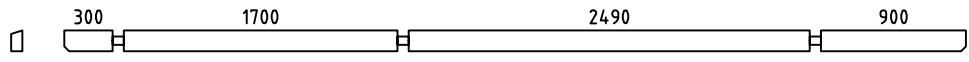
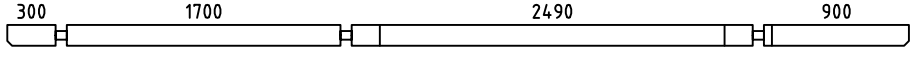
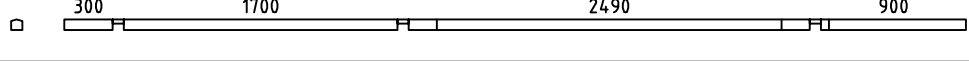
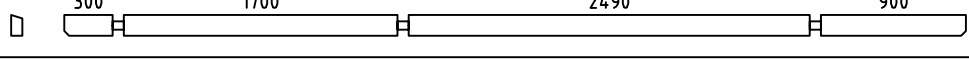
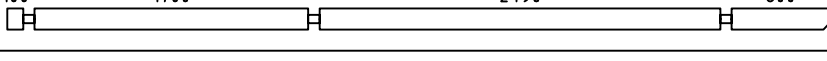
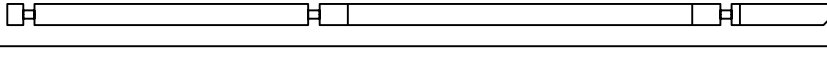
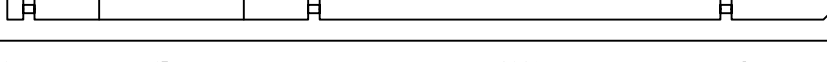
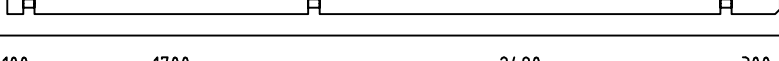
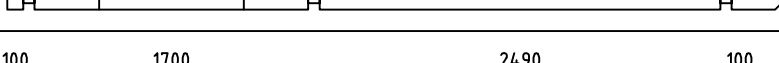
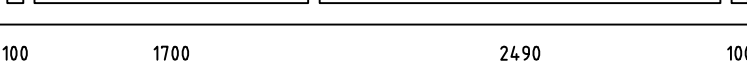
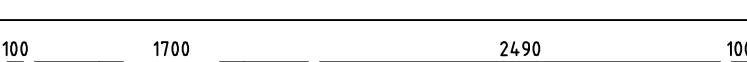
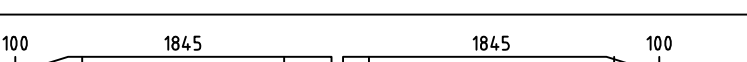

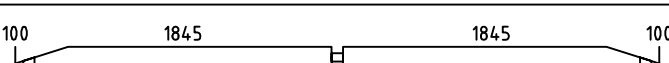

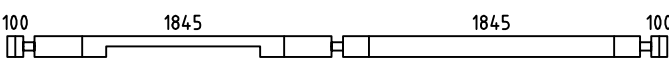
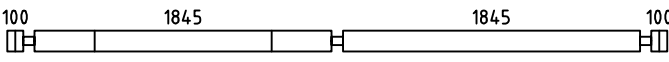
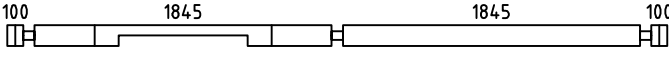
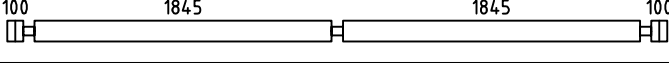
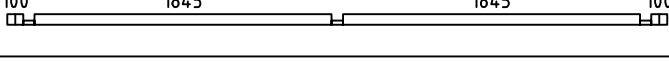
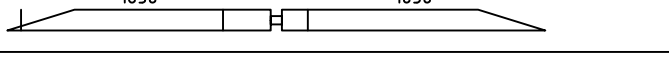
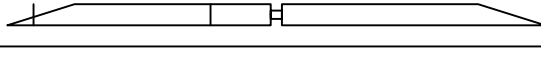

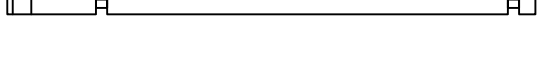
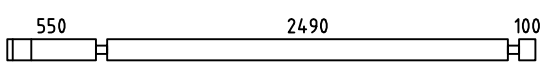

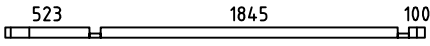
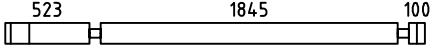
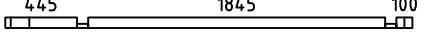
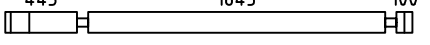
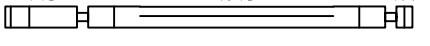

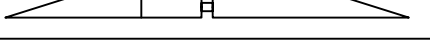
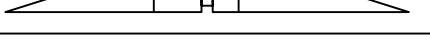
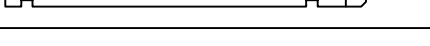
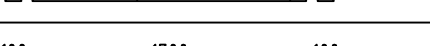
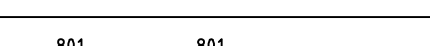
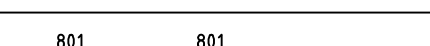
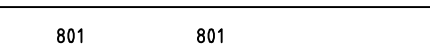
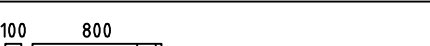







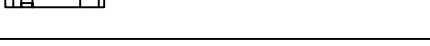



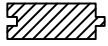

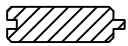
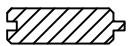
Baltic 16 Hurmi//70/19

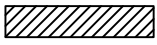

Baltic 16 Hurmi//70/19

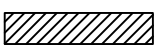
Pos	Baltic 16 Hurmi///70/19	ST	F (mm)	L (mm)
001		1	70x130	5600
002		1	70x130	5600
003		1	70x65	5600
004		1	70x130	5600
005		1	70x130	5100
006		1	70x130	5100
007		1	70x130	5100
008		1	70x130	4800
009		1	70x130	4800
010		22	70x130	4600
011		1	70x130	4600
012		1	70x130	4600
013		1	70x130	4100
014		1	70x130	4100
015		1	70x130	4100
016		1	70x130	4100
017		1	70x130	4100
018		1	70x130	4100
019		1	70x130	4100
020		16	70x130	4100
021		1	70x65	4100
022		1	70x130	3342
023		1	70x130	3342
024		1	70x130	3342
025		4	70x130	3280

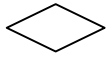
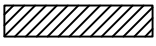
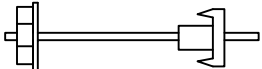
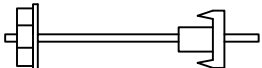
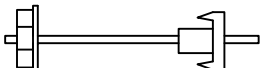
Pos	Baltic 16 Hurmi///70/19	ST	F (mm)	L (mm)
026		1	70x65	2608
027		14	70x130	2608
028		1	70x65	2530
029		6	70x130	2530
030		1	70x130	2530
031		1	70x130	2507
032		1	70x130	2507
033		1	70x130	2507
034		1	70x130	2240
035		2	70x130	2040
036		1	70x130	2040
037		1	70x130	1671
038		1	70x130	1671
039		1	70x130	1671
040		15	70x130	970
041		7	70x130	838
042		1	70x119	836
043		1	70x119	836
044		1	70x119	836
045		4	70x130	720
046		1	70x65	693
047		14	70x130	693
048		1	70x130	670
049		1	70x65	615
050		14	70x130	615

Pos	Baltic 16 Hurmi///70/19		ST	F (mm)	L (mm)
054	Fussbodenbretter		28	90x26	3756
055	Fussbodenbretter	Värvitud laudisega 	38	90x26	1830
056	Dachbretter		126	90x20	2350
057	Innenschalungsbretter		20	90x20	1920
058	Abdeckleiste			20x40	58m
059	Giebelbretter		4	20x120	2650
060	Giebelbretter		4	20x90	2650
061	Giebeldeckbretter		8	20x70	2650
062	Traufenbrett		4	20x90	2950
063	Träger für Traufenbrett		4	50x50	2950
064	Saunalava kontstruktsioon		4	70x140	1900
DT1	Innenschalungsträger		2	50x50	1700
065	Giebelsegment		2		
066	Trenleiste		1	25x70	700
G1	Gewindestift12		1		2815
G2	Gewindestift12		6		2295
G3	Gewindestift12		2		475
KMPL		für Fundament	30		
	Schrauben	für Fundament	240	3,5x50	
	Schrauben+Dübel (lööktüübel)	für Fundament	25	8x160	
	Schrauben	für Wand, Giebel, Dachbalken	80	5x120	
	Schrauben	für Leisten usw.	300	3,5x50	
	Nägel	für Fussboden und Dach	3kg	2,5x60	

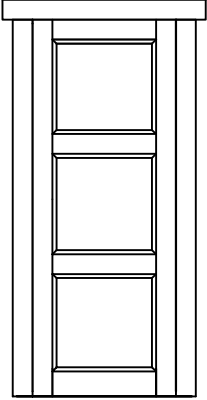
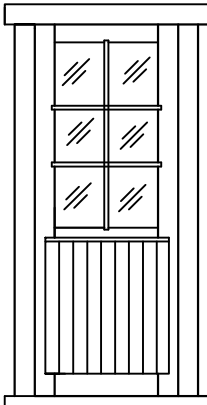
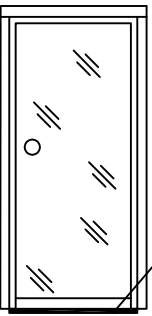
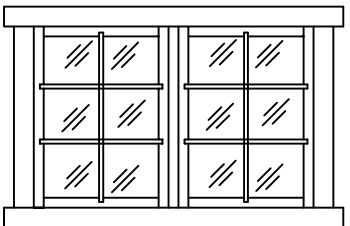
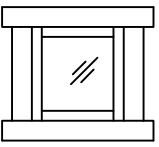
Pos	Baltic 16 Hurmi///70/19	ST	F (mm)	L (mm)				
T1	<p>Tür 800x1950</p>  <p>kotike 1 kmpl.</p> <p>Tenderliist 23x23x1855=2tk.</p>	1R						
T2	<p>AB</p> <p>Tür 955x1950</p>  <table border="1" data-bbox="614 728 1013 817"> <tr> <td>Iso</td> <td>970x690</td> </tr> <tr> <td colspan="2">kotike 1 kmpl.</td> </tr> </table> <p>Tenderliist 23x23x1855=2tk.</p> <p>Algab alusraamilt!</p>	Iso	970x690	kotike 1 kmpl.		1L		
Iso	970x690							
kotike 1 kmpl.								
T3	<p>Sauna uks</p> <p>Tür 700x1900</p>  <p>Ava seinas 700x1950 Jäab alt lahti !! Õhu vahe 50mm</p> <p>Tenderleiste 23x23x1920=2st.</p>	1R						
F1	<p>BC</p> <p>Fenster 1200x910</p>  <table border="1" data-bbox="686 1646 1085 1736"> <tr> <td>Iso</td> <td></td> </tr> <tr> <td colspan="2"></td> </tr> </table> <p>Tenderleiste 23x23x870=2st.</p>	Iso				1		
Iso								
F2	<p>BC</p> <p>Fenster 600x600</p>  <table border="1" data-bbox="582 1982 981 2072"> <tr> <td>Iso</td> <td></td> </tr> <tr> <td colspan="2"></td> </tr> </table> <p>Tenderleiste 23x23x480=2st.</p>	Iso				1R		
Iso								