

Falkland
Art. Nr. 4414193
1/19



VERSION A

06.03.2018

Groundplan - Grundplan - Plan de masse - Planimetria - Plattegrond - Põhiplaan

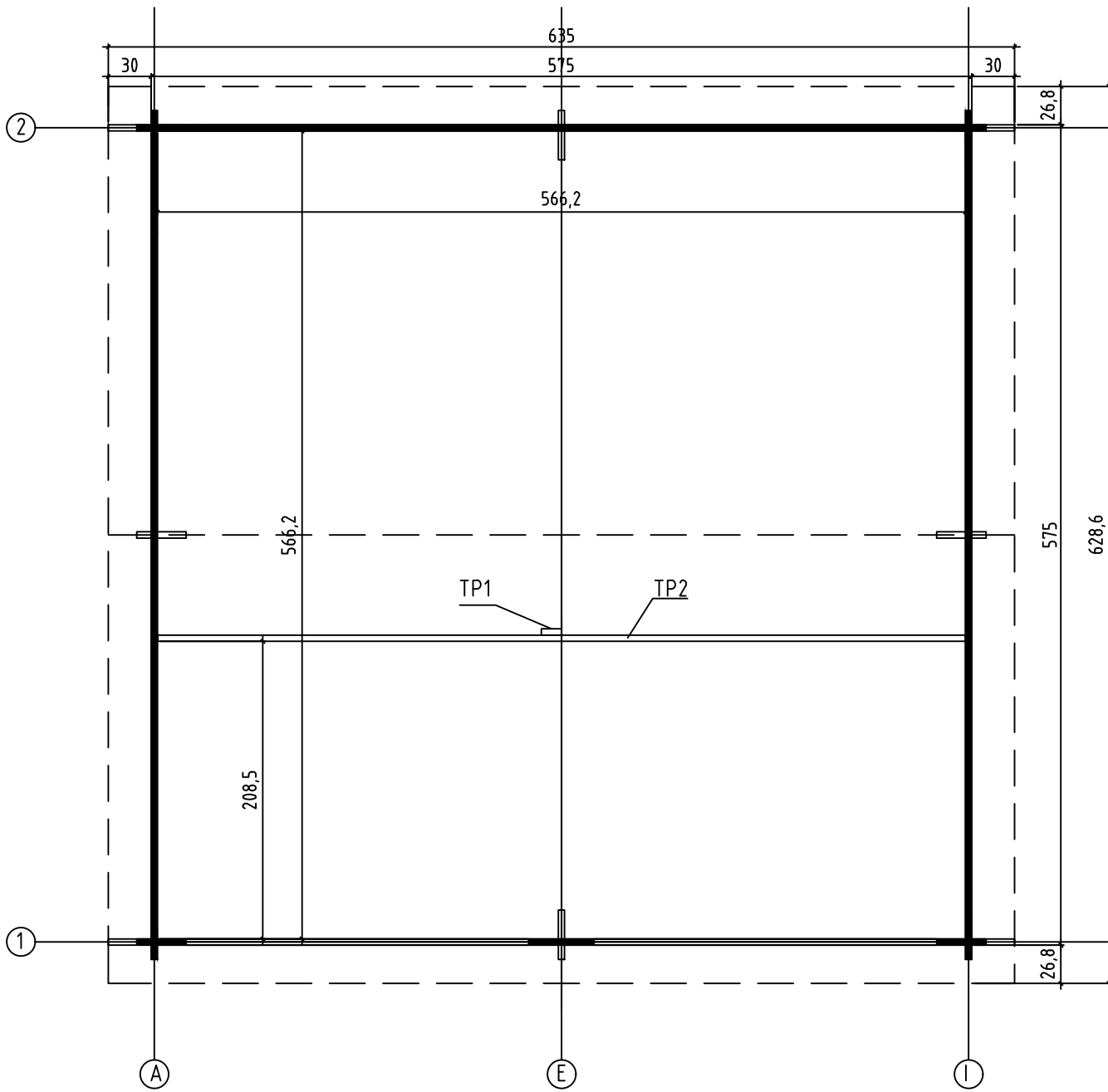

Foundation - Fundament - Fondation - Fundamenta -Fundering - Immutatud alusraam

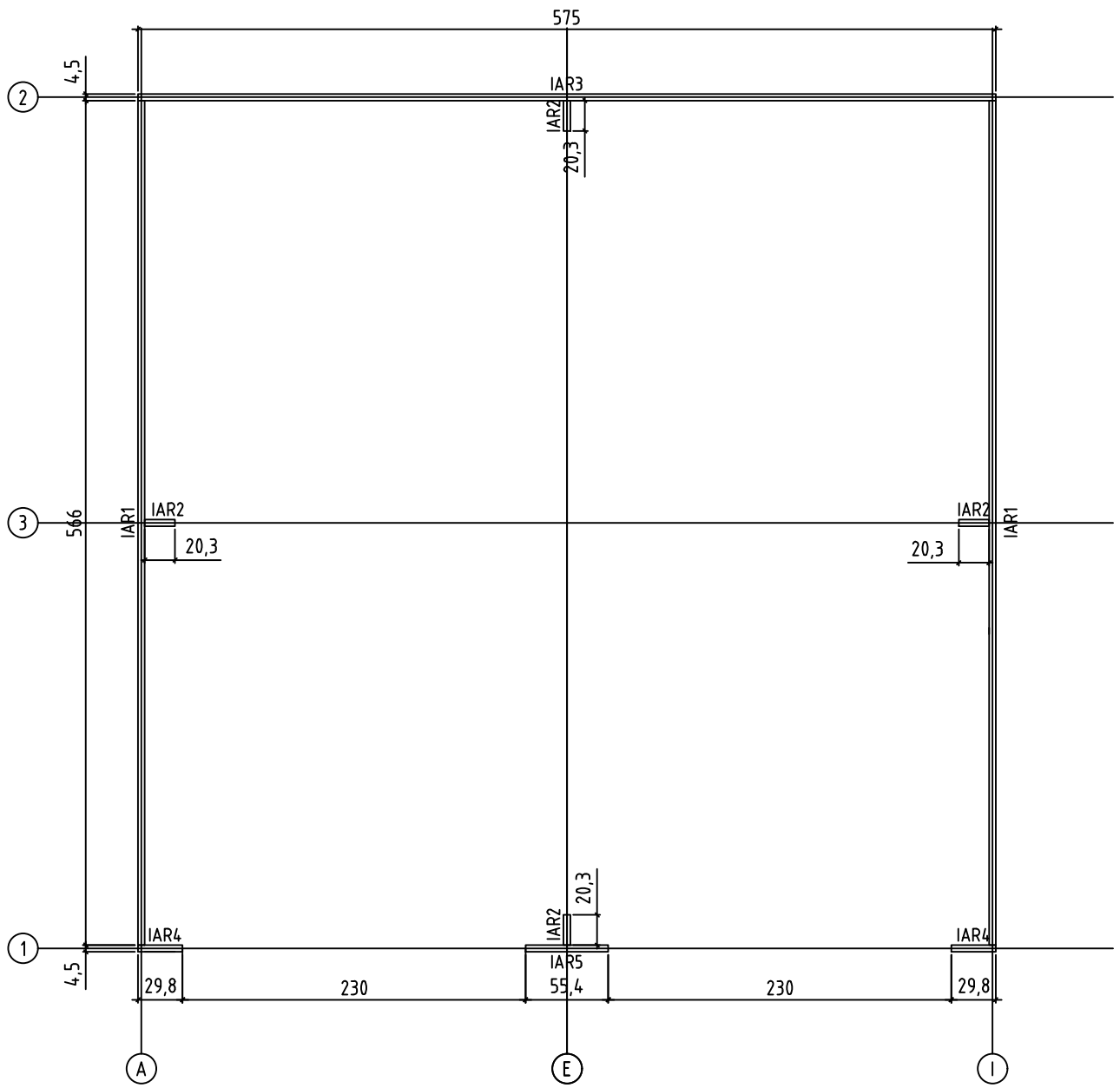

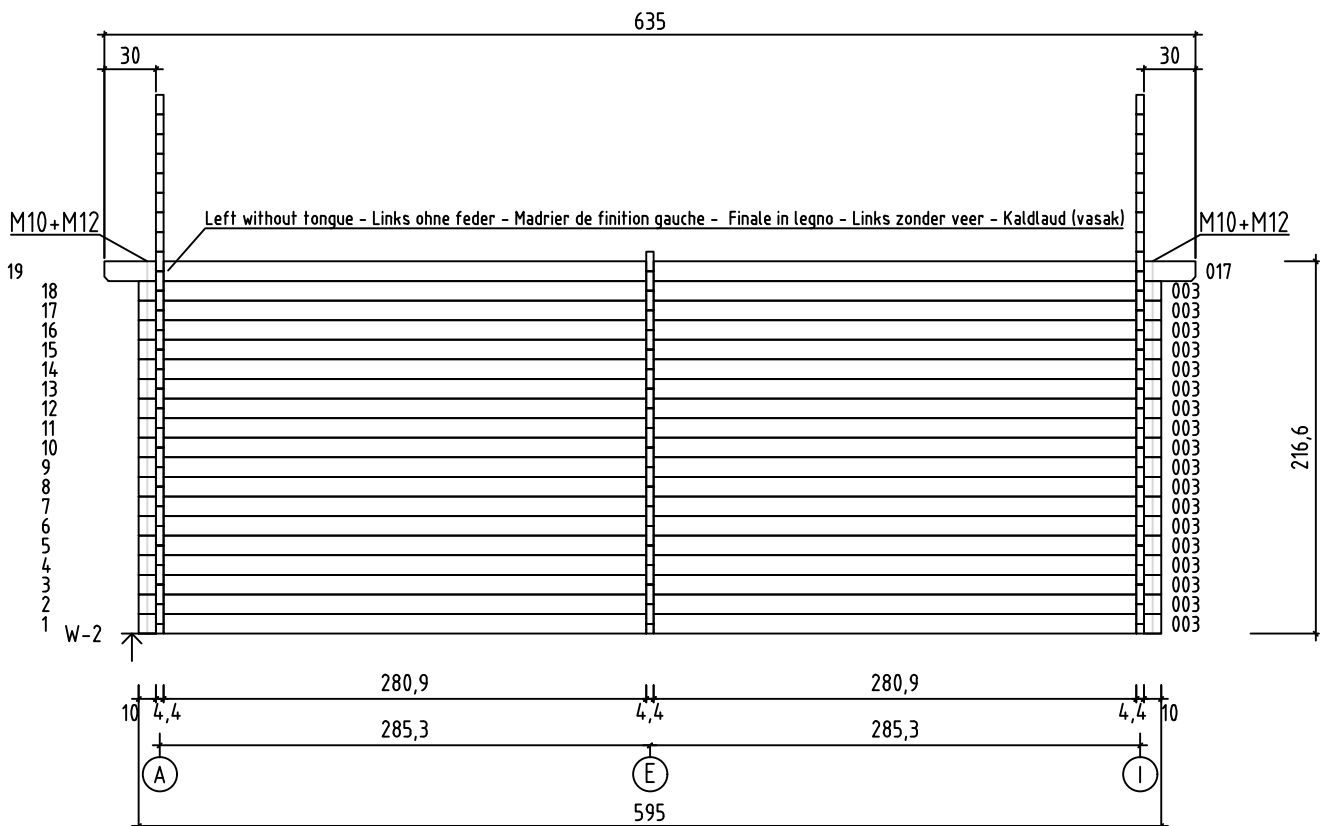
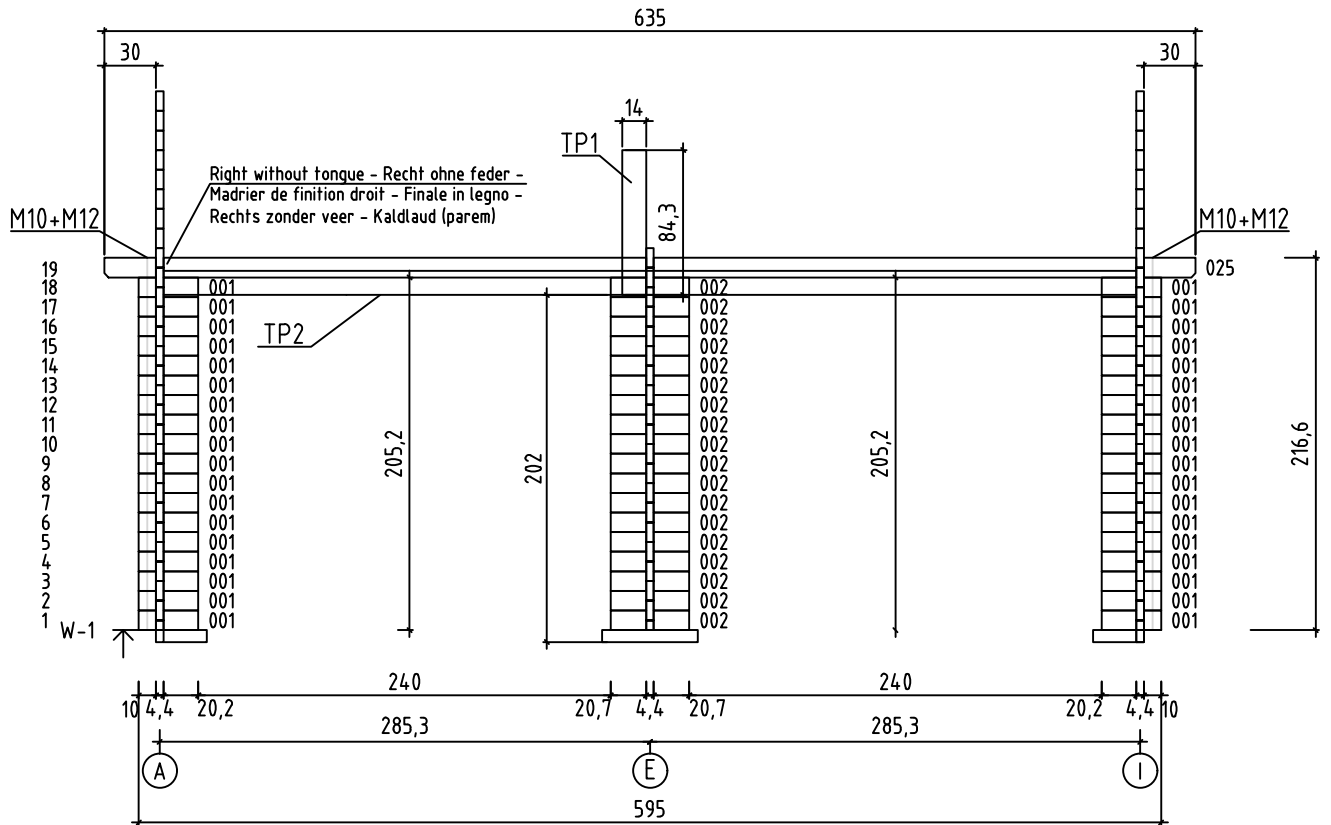

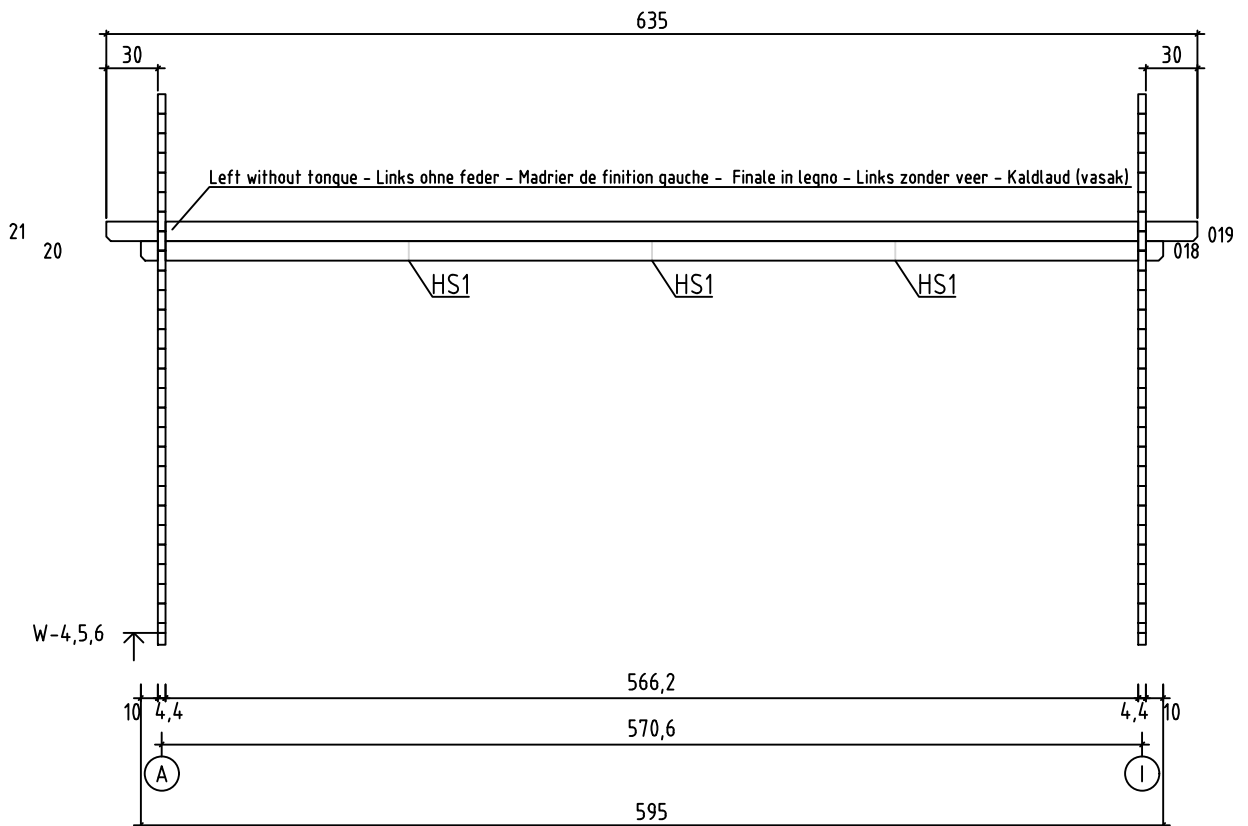
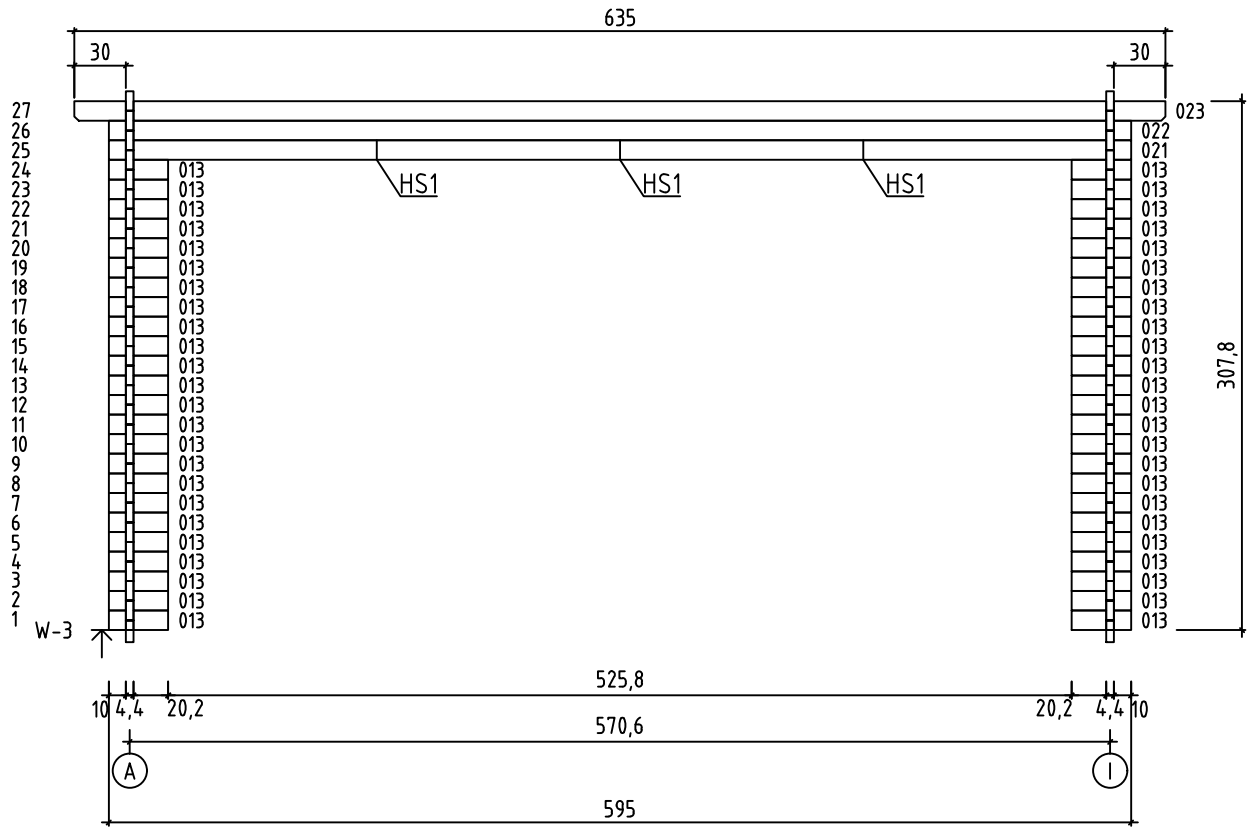

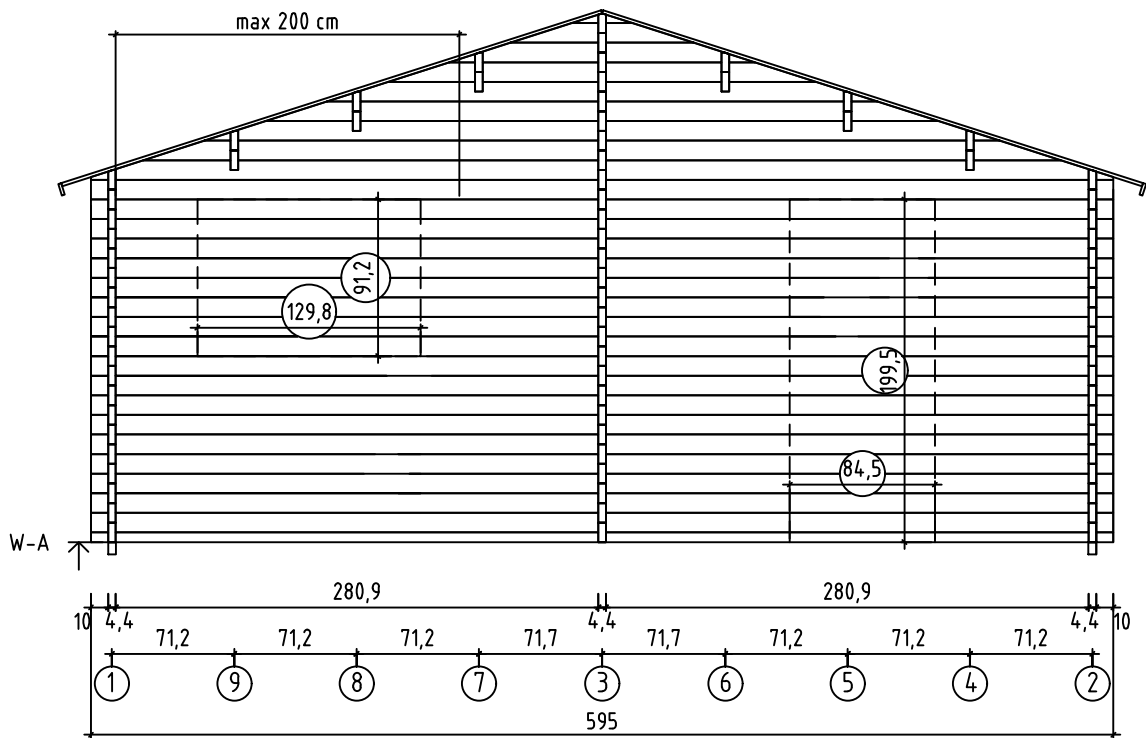

A single door (83.5x195.7 cm) and a single window (129.8x88.2 cm) has been delivered together with the building. You can choose the location for the door by yourself by cutting the wall logs as shown in the picture (see the dotted line).

Im lieferumfang ist eine einzeltür sowie ein einzelfenster enthalten.

Dafür sind aber werksseitig keine aussparungen vorgesehen so dass sie sowohl fenster als auch tür individuell verbauen können. eine anleitung hierfür entnehmen sie bitte der montageanleitung (siehe bild).

Le positionnement de la porte de service et de la fenêtre nécessite la découpe préalable des madriers. Veuillez respecter les cotes de coupes dans les madriers indiquées sur le schéma. vous pouvez positionner, selon votre convenance, les ouvertures de chaque côté ou à l'arrière du garage.

Una porta singola (83.5x195.7 cm) ed una finestra singola (129.8x88.2 cm) é stata consegnata con la casa. Tu puoi scegliere la posizione della porta secondo il tuo gradimento. tagliando la parete come raffigurato nella fotografia (segui la linea tratteggiata).

Bij uw huisje is een losse enkele deur (83.5x195.7 cm) en een los raam (129.8x88.2 cm) geleverd. U heeft hierin een vrije keuze waar u deze wilt inbouwen, door het inzagen van de wandbalk zoals op de tekening (zie de stippellijn).

Majakomplekt sisaldab üksikut (83.5x195.7 cm) ja üksikakent (129.8x88.2 cm), mille asukoht on võimalik ise valida. Ukseava tuleb lõigata joonisel näidatud mõõtudes (vaadake punktiirjooni).

Falkland
Art. Nr. 4414193
9/19



VERSION B

06.03.2018

Groundplan - Grundplan - Plan de masse - Planimetria - Plattegrond - Põhiplaan

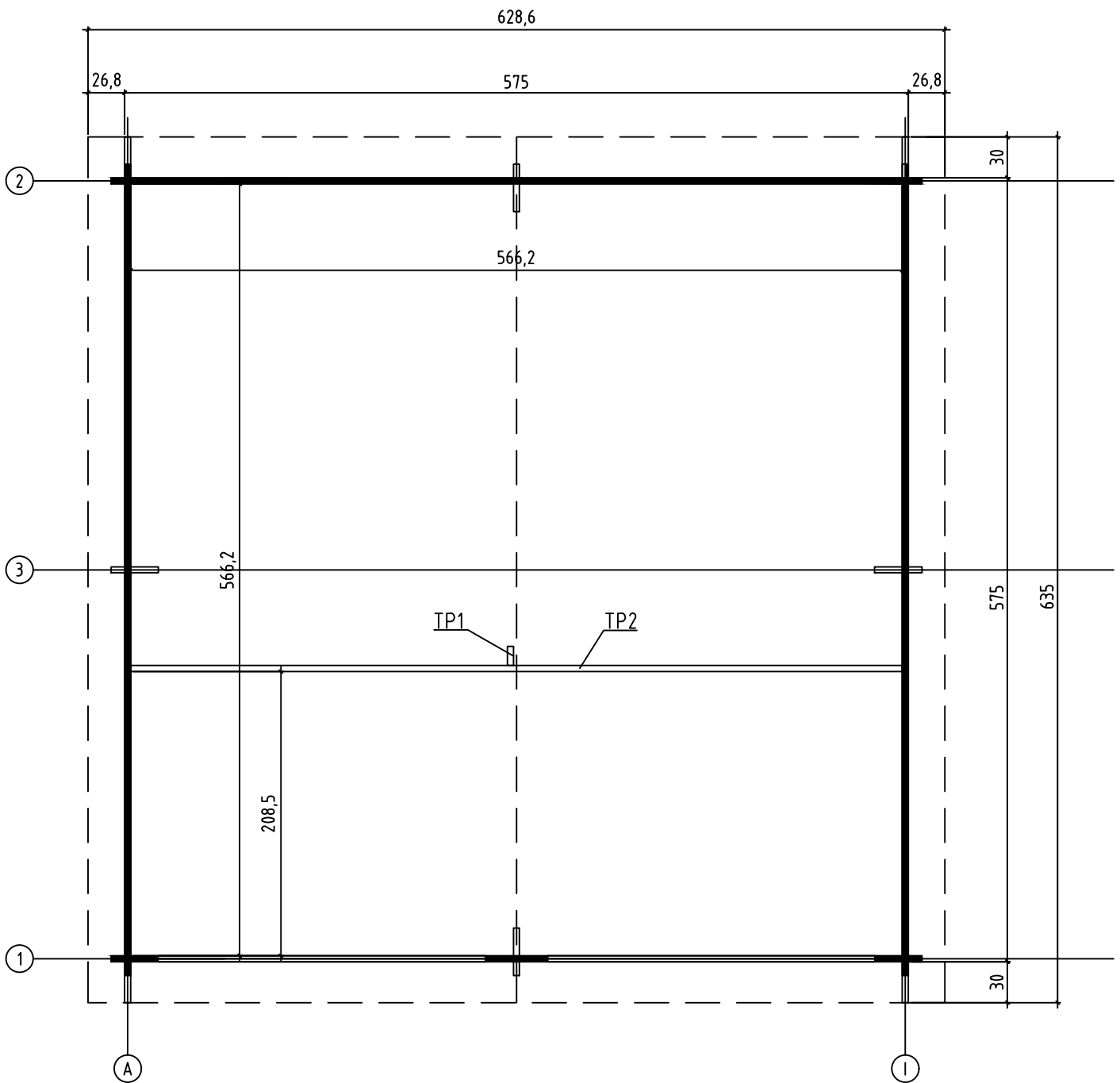

Foundation - Fundament - Fondation - Fundamenta -Fundering - Immutatud alusraam

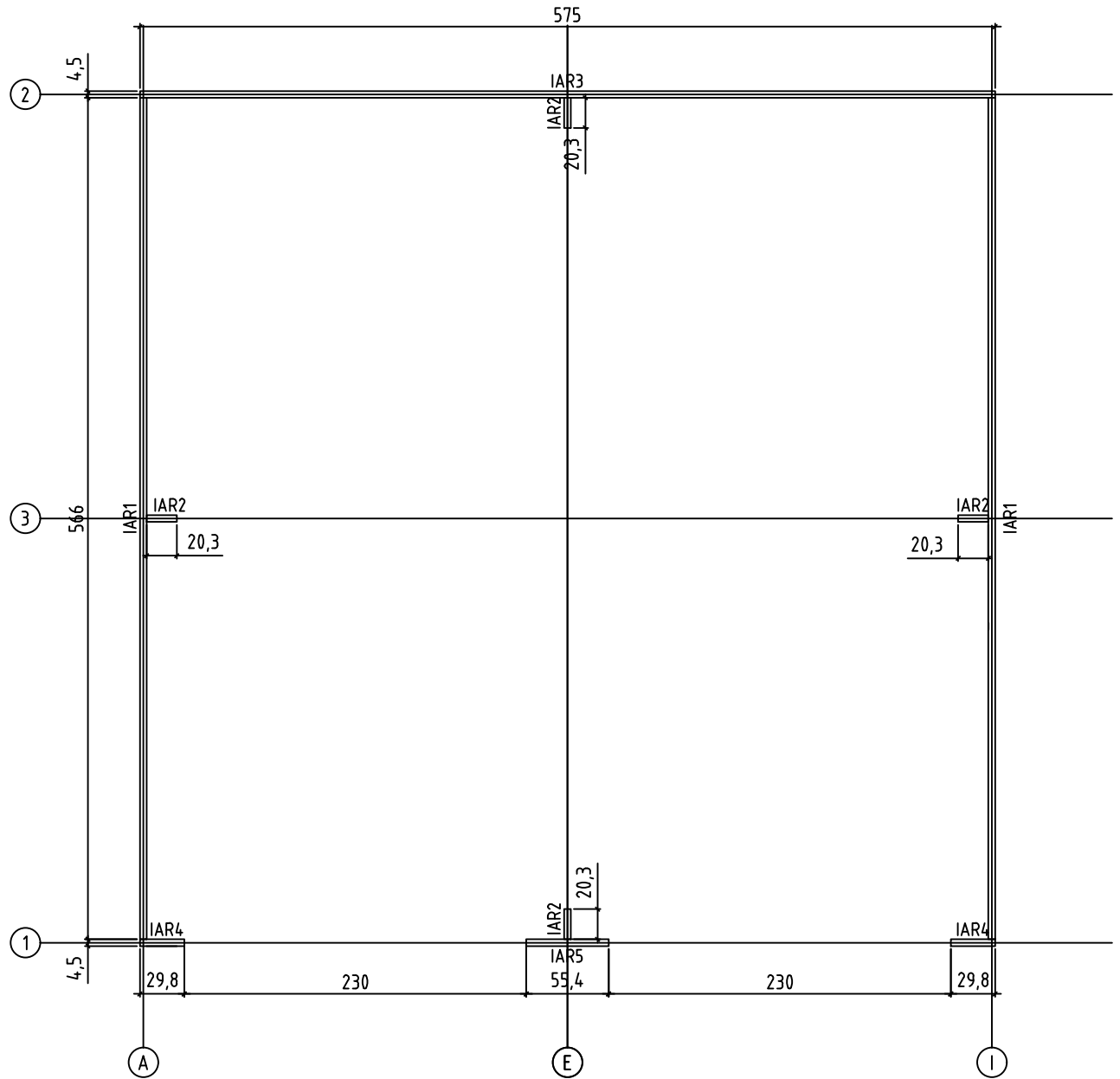

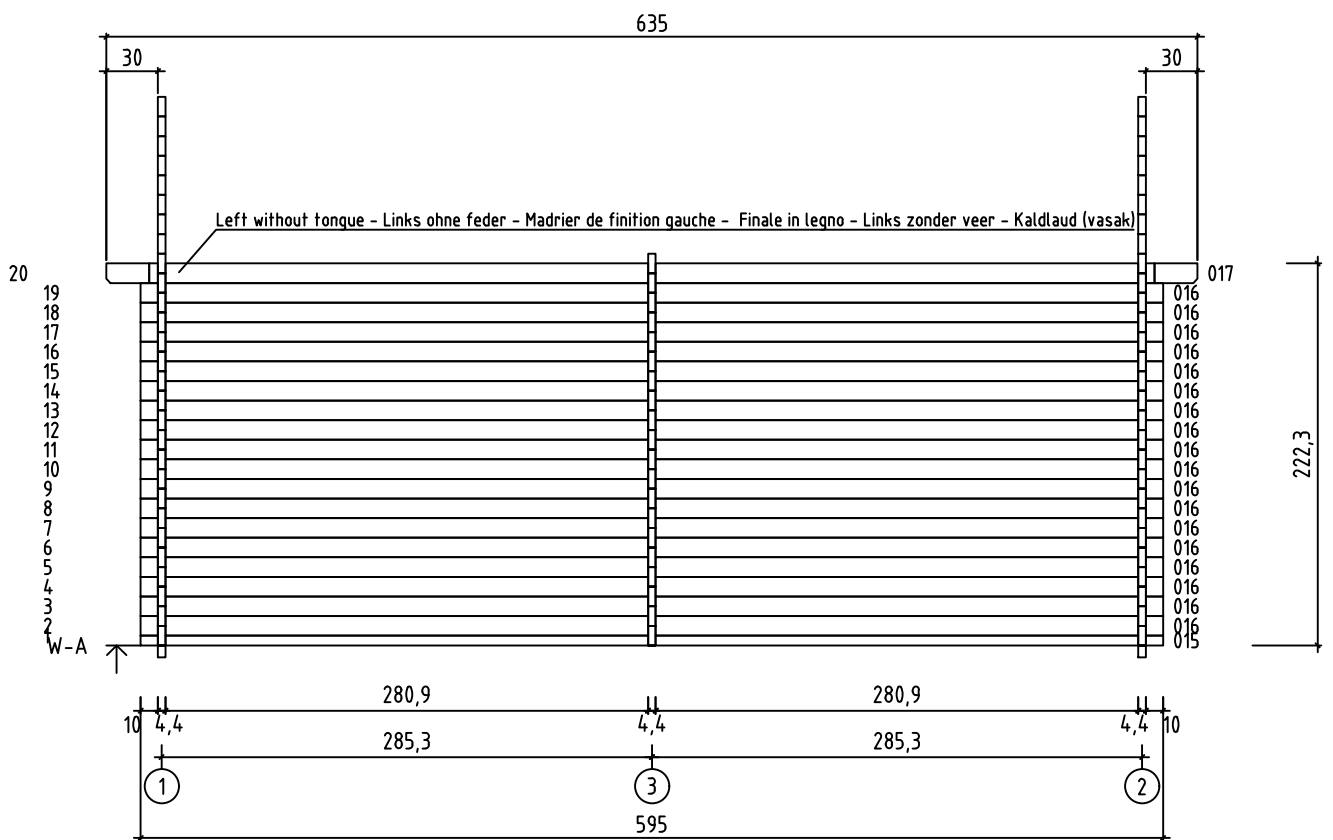
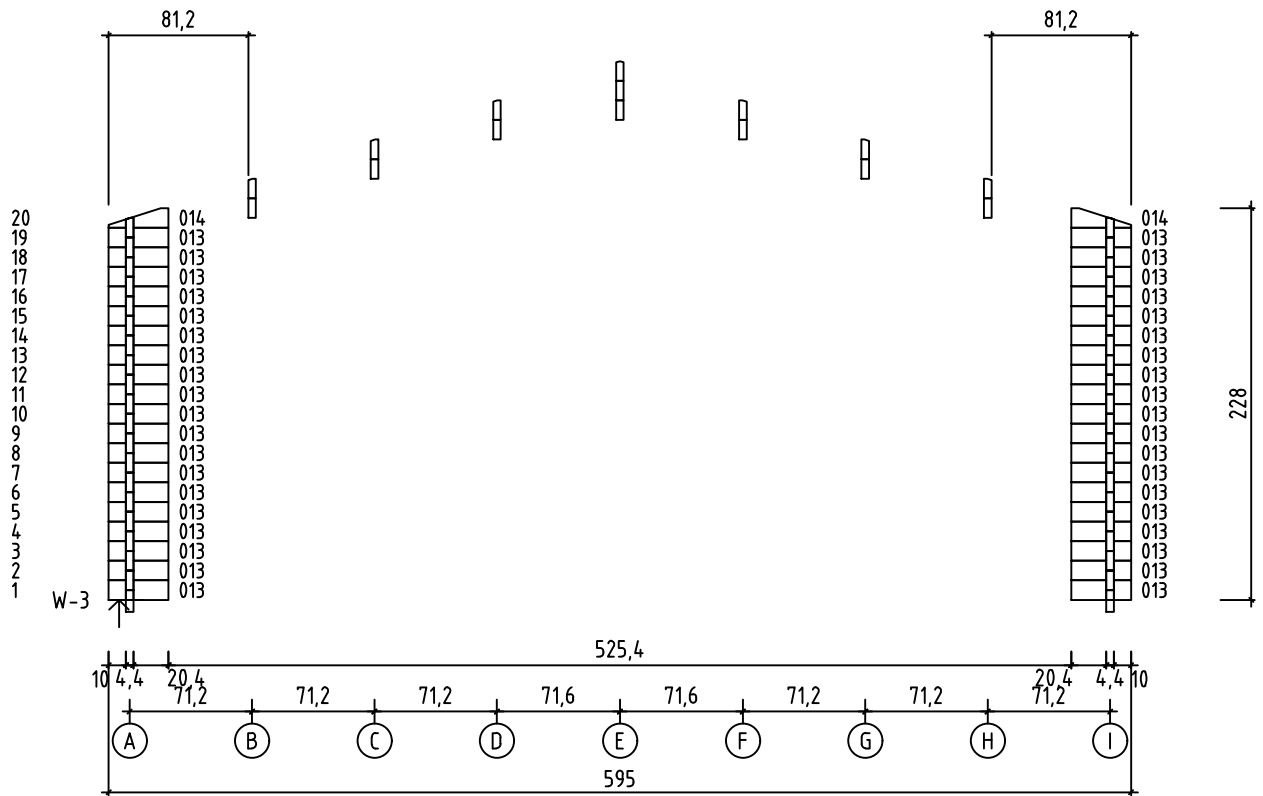

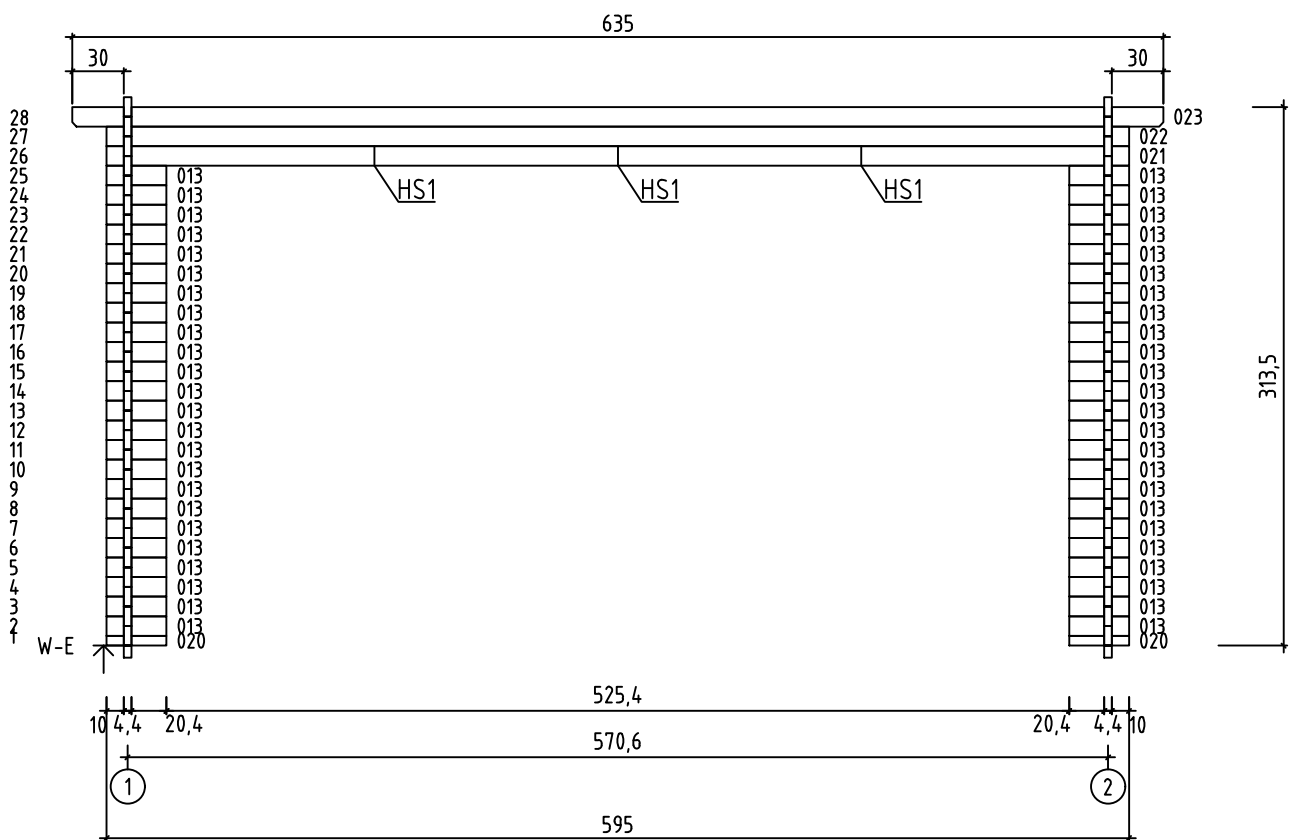
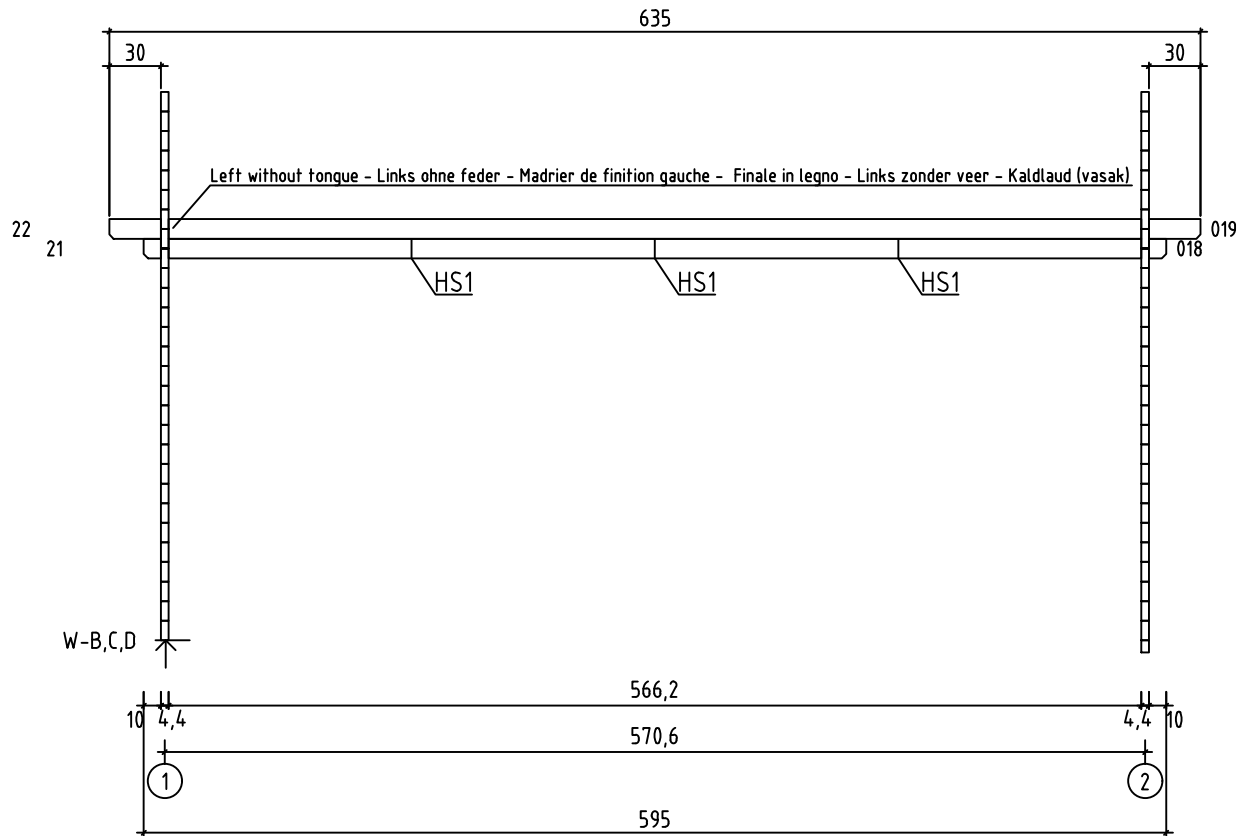

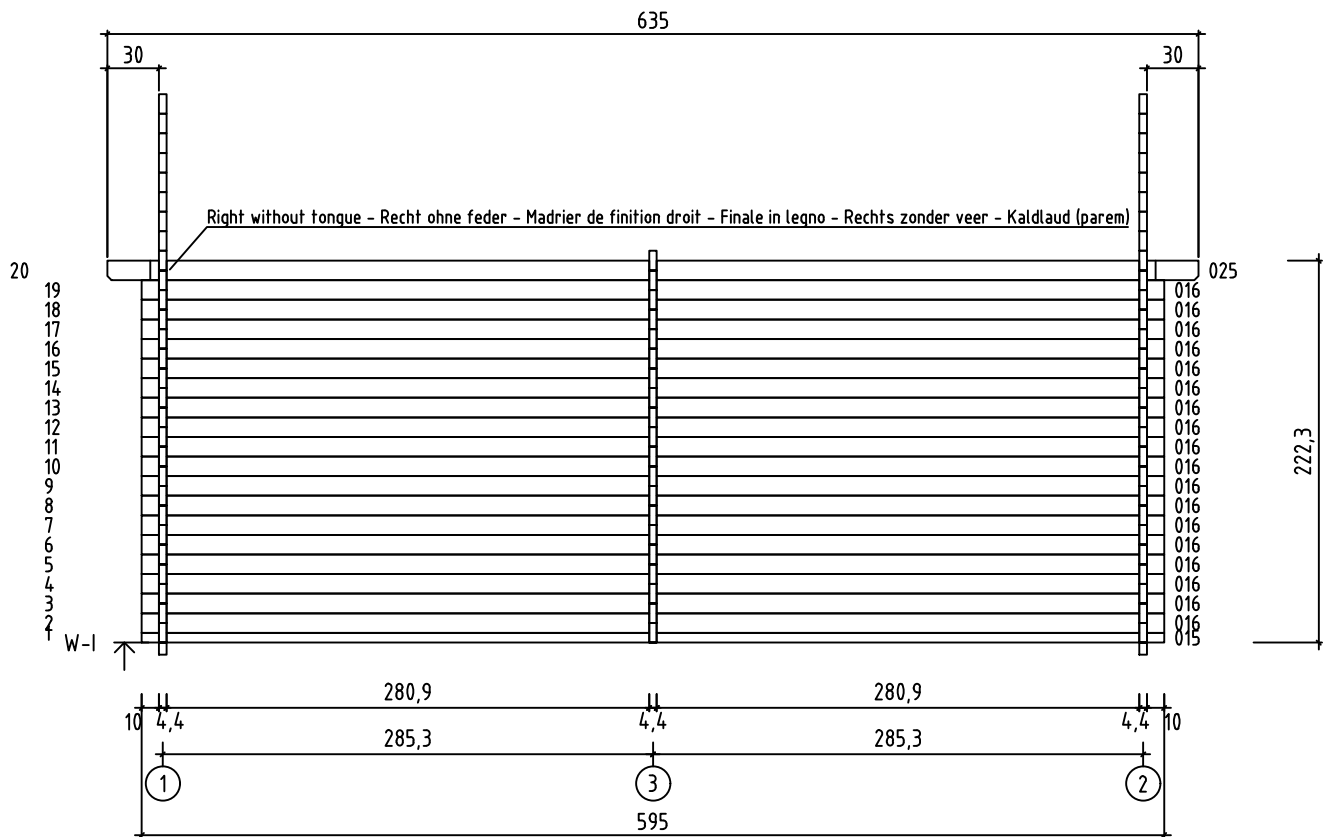
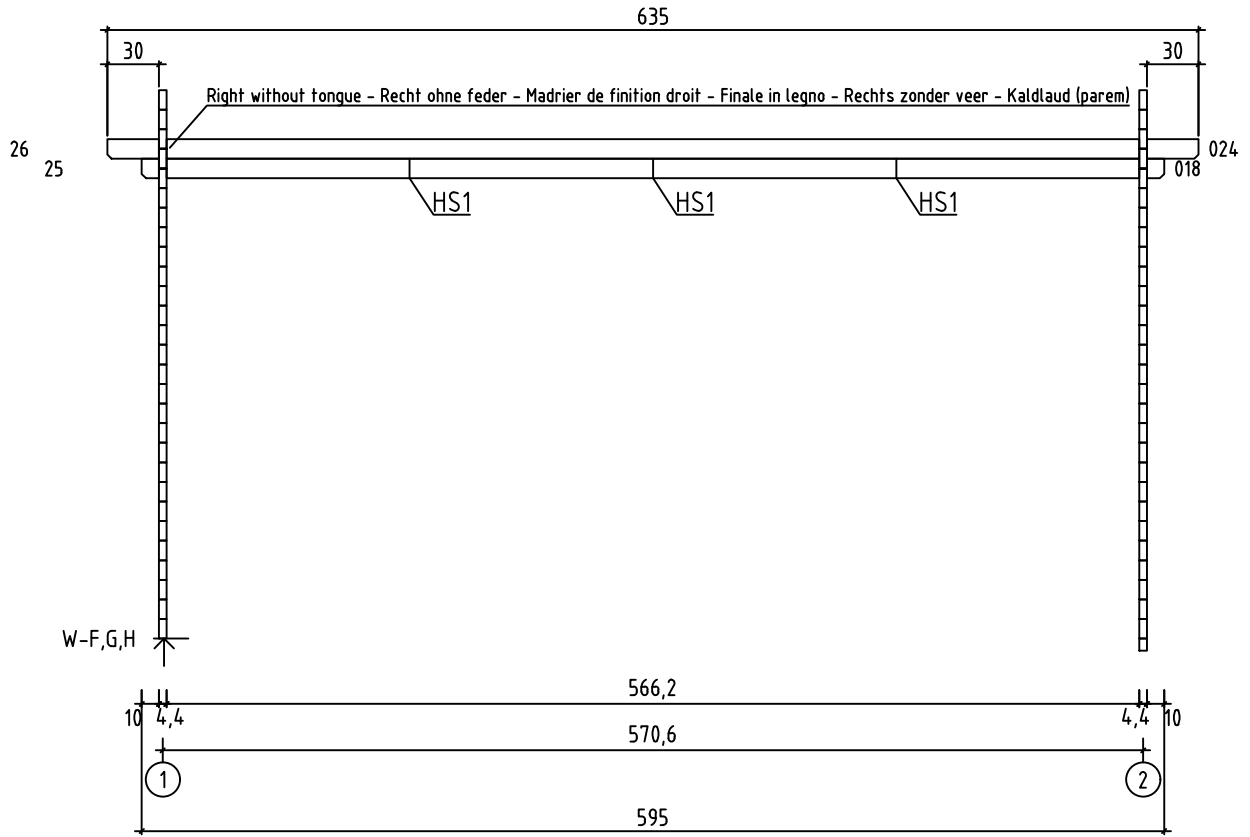

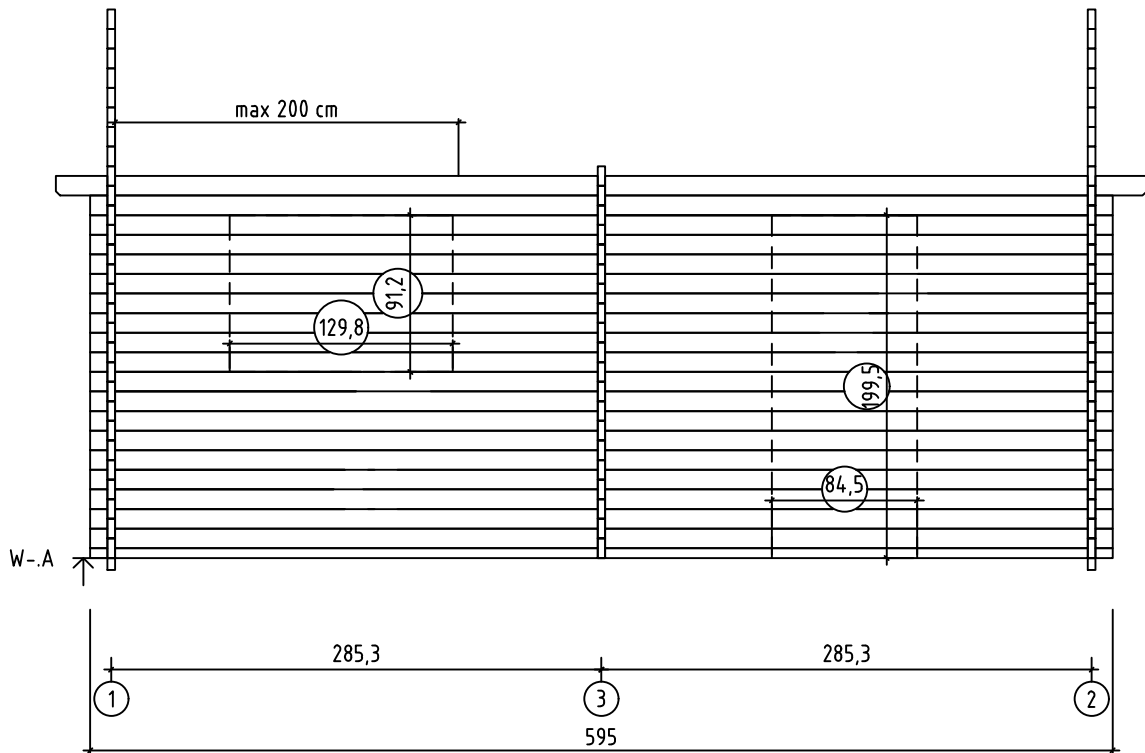

A single door (83.5x195.7 cm) and a single window (129.8x88.2 cm) has been delivered together with the building. You can choose the location for the door by yourself by cutting the wall logs as shown in the picture (see the dotted line).

Im lieferumfang ist eine einzeltür sowie ein einzelfenster enthalten.











Dafür sind aber werksseitig keine aussparungen vorgesehen so dass sie sowohl fenster als auch tür individuell verbauen können. eine anleitung hierfür entnehmen sie bitte der montageanleitung (siehe bild).

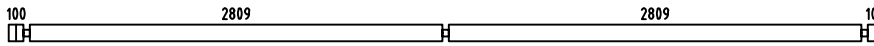

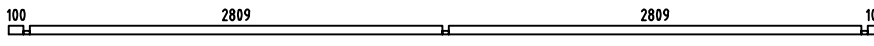
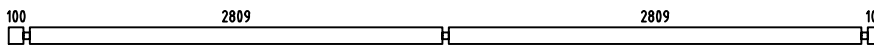
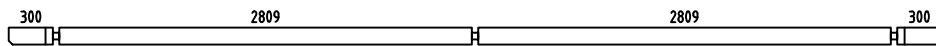
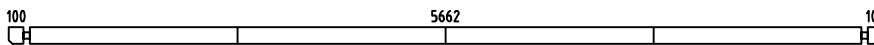
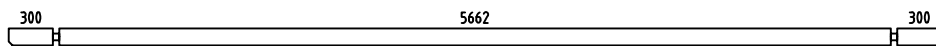

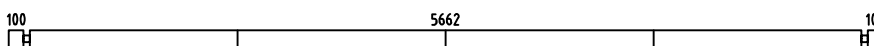
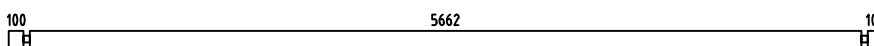
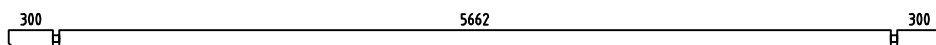
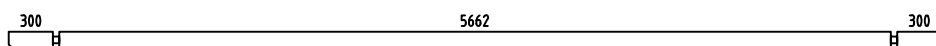
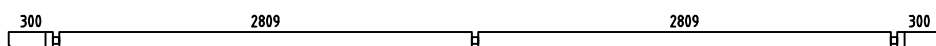
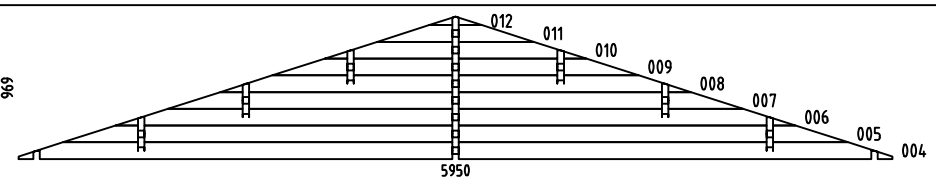
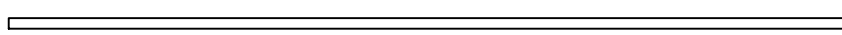
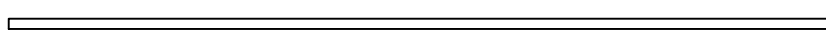









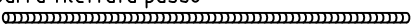
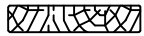

Le positionnement de la porte de service et de la fenêtre nécessite la découpe préalable des madriers. Veuillez respecter les cotes de coupes dans les madriers indiquées sur le schéma. vous pouvez positionner, selon votre convenance, les ouvertures de chaque côté ou à l'arrière du garage.

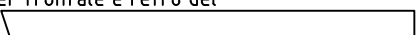

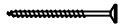
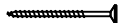

Una porta singola (83.5x195.7 cm) ed una finestra singola (129.8x88.2 cm) é stata consegnata con la casa. Tu puoi scegliere la posizione della porta secondo il tuo gradimento. tagliando la parete come raffigurato nella fotografia (segui la linea tratteggiata).

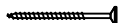
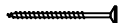
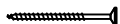
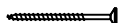

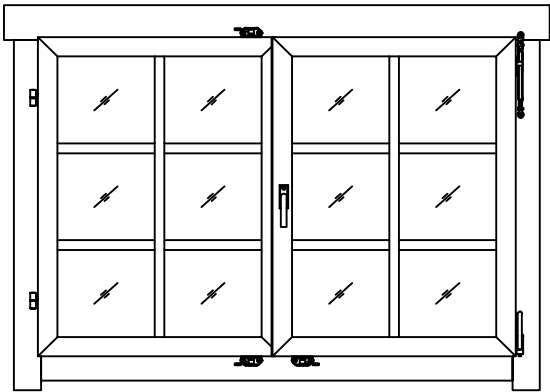
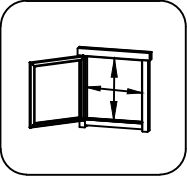

Bij uw huisje is een losse enkele deur (83.5x195.7 cm) en een los raam (129.8x88.2 cm) geleverd. U heeft hierin een vrije keuze waar u deze wilt inbouwen, door het inzagen van de wandbalk zoals op de tekening (zie de stippellijn).

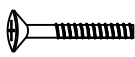
Majakomplekt sisaldab üksikut (83.5x195.7 cm) ja üksikakent (129.8x88.2 cm), mille asukoht on võimalik ise valida. Ukseava tuleb lõigata joonisel näidatud mõõtudes (vaadake punktiirjooni).

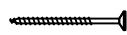
Pos	06.03.2018 Piece list - Stückliste - Liste des pièces - Elementi - Stuklijst - Tükitalabel Art.nr. 4414193	17/19	Q	P (mm)	L (mm)
001			36	44x114	348
002			18	44x114	454
003			20	44x114	5950
013			86	44x114	348
014			2	44x114	348
015			2	44x57	5950
016			36	44x114	5950
017			1	44x120	6350
018			6	44x114	5950
019			3	44x120	6350
020			2	44x57	348
021			1	44x114	5950
022			1	44x114	5950
023			1	44x114	6350
024			3	44x120	6350
025			1	44x120	6350
W1-1 W2-1			1 1		
IAR3	 Foundation - Fundament - Fondation - Fondamenta - Fundering - Immutatud alusraam		1	45x70	5750
IAR1	 Foundation - Fundament - Fondation - Fondamenta - Fundering - Immutatud alusraam		2	45x70	5660
IAR5	 Foundation - Fundament - Fondation - Fondamenta - Fundering - Immutatud alusraam		1	45x70	554
IAR4	 Foundation - Fundament - Fondation - Fondamenta - Fundering - Immutatud alusraam		2	45x70	298
IAR2	 Foundation - Fundament - Fondation - Fondamenta - Fundering - Immutatud alusraam		4	45x70	203

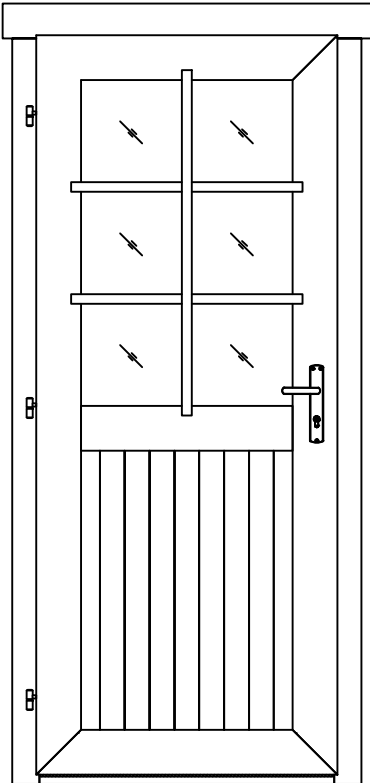
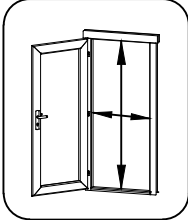
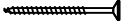
Pos	06.03.2018 Piece list - Stückliste - Liste des pièces - Elementi - Stuklijst - Tükitalabel Art.nr. 4414193	18/19	Q	P (mm)	L (mm)
	Roof boards - Dachbretter - Voliges - Perlina per tetto - Dakhout - Katuselaud 		142	90x18	3300
	Roofing felt fillet - Dachpappenleiste - Baguette de fixation du feutre bitumeux - Asse per fissaggio guaina bituminosa - Afdekljst asfaltpapier - Katusepapiilist 		4	18x58	3350
M12	Treaded rod m10 - Gewindestange m10 - Tige filetée m10 - Barra filettata passo m10 - Draadstang 10m - Keermelatt 		4		200
M11	Treaded rod m10 - Gewindestange m10 - Tige filetée m10 - Barra filettata passo m10 - Draadstang 10m - Keermelatt 		4		230
M10	Treaded rod m10 - Gewindestange m10 - Tige filetée m10 - Barra filettata passo m10 - Draadstang 10m - Keermelatt 		4		2000
TB-1	Fascia board - Traufbrett - Bandeau de toit - Finitura lati tetto - Gevellijst - Räästalaud 		4	18x70	3175
DRV-1	Roof edge reinforcement - Dachrandverstärkung - Corniere de renfort de bord de toit - Rinforzo x tetto - Dakrand versterking - Räästatugevdus 		4	28x34	3175
TP1	Support beam for gate frame - Stutzbohle für torzarge - Madrier de support du cadre de la porte basculante - Asse di supporto per il telaio della porta - Steunpaal voor poort-/ deurkozijn - Tugipuu 		1	44x140	1014
TP2	Support beam for gate frame - Stutzbohle für torzarge - Madrier de support du cadre de la porte basculante - Asse di supporto per il telaio della porta - Steunpaal voor poort-/ deurkozijn - Tugipuu 		1	44x140	5660
	Gable moulding - Giebelleiste - Planche de rive - Finitura per frontale e retro del tetto - Gevellijst - Viilulaud 		4	18x120	3350
KL4	Lengthening bolt for treaded rod - Verlängerungsmutter für gewindestange - Manchon de raccordement de tige filetée - Bullone per barra filettata passo - Extensie moer voor draadstang - Keermelati jätkumutter 		4		
KL1	Drive nut treaded rod - Einshlagmutter für gewindestange - Écrou a frapper pour tige filetée - Dado guida per barra filettata - Aandrijfmoer / aanslagmoer voor draadstang - Löökmutter keermelatile 		4		
KL2	Nut for treaded rod - Mutter für gewindestange - Écrou pour tige filetée - Dado per barra filettata - Moer voor draadstang - Mutter keermelatil 		4		
KL3	Plain washer treaded rod - Unterlegscheibe für gewindestange - Rondelle plate pour tige filetée - Rondella per barra filettata - Sluifring voor draadeind - Seib keermelatile 		4		
HS8	Screw for gable segment - Schrauben für deckblatt - Vis pour fixation losange de finition - Viti x frontali tetto - Schroef voor gevelpunt segment - Kruvi rombile 		4	3.5x35	
HS9	Screw for gable moulding - Schrauben für giebelleiste - Vis pour fixation planche de rive - Vite per fissare finiture davanti e dietro del tetto - Schroef voor gevellijst - Kruvi viilulauale 		40	3.5x50	
HS84	Screw for support beam - Schrauben für stutzbohle für torzarge - Vis de madrier de support du cadre de la porte basculante - Vite per l'asse di supporto - Schroef voor steunbalk deurkozijn - Kruvi tugipuule 		6	4.5x80	
HS12	Screw for fascia boards - Schrauben für traufbretter - Vis pour fixation bandeau de toit - Viti x striscia del tetto - Schroef voor gevellijst - Kruvi räästalauale 		28	4x40	
HS12	Screw for roof edge reinforcement - Schrauben für dachrandverstärkung - Vis pour fixation corniere renfort de bord de toit - Viti x rinforzo bordo tetto - Schroef voor dakrand versterking - Kruvi räästatugevdusele 		28	4x40	
HS18	Screw for gable - Schrauben für giebel - Vis pour fixation des pignons - Viti per timpano - Schroef voor gevelpunt - Kruvi viilude kinnitamiseks 		40	5x120	
HS16	Screw for 1. wall beam - Schraube für 1. bohlenreihe - Vis de fixations 1ere rangée de madriers avec poutrelles de fondations - Vite fissaggio alle fondamenta - Schroef voor 1 wandbalk - Kruvi poollauale 		14	5x90	
HS16	Screw for foundation - Schrauben zur befestigung fundament - Vis de fixations des poutrelles de fondations - Viti x fondamenta - Schroef voor fundering - Kruvi alusraamile 		8	5x90	
HS1	Screw for wall details 018, 021 - Schraube für wand details 018, 021 - Vis pour mur details 018, 021 - Viti per elementi della porta 018, 021 - Schroef voor wand details 018, 021 - Kruvi seinadetailidele 018, 021 		21	8x220	

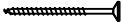
Pos	02.01.2018 Piece list - Stückliste - Liste des pièces - Elementi - Stuklijst - Tükítabel 1290x882 TAK.1.106.TSSP.a SGC	1/1	Q	P (mm)	L (mm)
<p data-bbox="260 152 1284 183">Glass size - Glasgröße - Taille de la vitre - Misura del vetro - Glas afmeting - Klaasi mõõt: 542x738 mm</p> <div data-bbox="577 241 1129 631" style="text-align: center;">  </div> <div data-bbox="1337 152 1524 331" style="text-align: right;">  <p data-bbox="1369 347 1492 376">1190x782 mm</p> </div>					
FS1	Window handle fittings - Fenstergriff - Poignee de fenetre - Maniglia c/ferramenta - Raamhendel -/grendel -/klink - Aknalink		1		
FSP	Bolt for window handle fittings - Bolzen für fenstergriff beschlag - Vis pour fixation poignee de fenetre - Bullone x apertura manuale finestra - Schroef voor raamhendel - Akna käepideme polt		2		
HS1	Screw for georgian bars - Schraube für sprossen - Vis pour croisillons - Viti per unire la griglia georgiana della finestra - Schroeven voor raamverdeling - Kruvi akna petteliistule		12	2.5x20	
HS4	Screw for window fillet - Schraube für glasleiste - Vis de filet de fenetre - Vite per assemblaggio finestra - Schroef voor glaslijst - Kruvi akna kokkuvaltšiliistule		3	3x30	

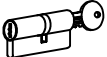
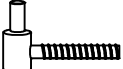
Pos	09.11.2017	Piece list - Stückliste - Liste des pièces - Elementi - Stuklijst - Tükítabel 835x1957 UK.2.056.TSVV.MM SGC	1/1	Q	P (mm)	L (mm)
		Glass size - Glasgröße - Taille de la vitre - Misura del vetro - Glas afmeting - Klaasi mõõt: 561x855 mm				
						
		 735x1875 mm				
HS1		Screw for georgian bars - Schraube für sprossen - Vis pour croisillons - Viti per unire la griglia georgiana della finestra - Schroeven voor raamverdeling - Kruvi ukse petteliistule		6	2.5x20	
HS16		Screw for door jamb - Schraube für Türrahmen - Vis de fixation partie haute avec montants du cadre de porte - Viti x fissaggio montanti porte - Schroef voor deurkozijn - Kruvi ukse lengile		4	5x90	
HS25		Screw for doorstep - Schrauben für swelle - Vis pour fixation barre de seuil - Vite per soglia della porta - Schroef voor deurdorpel - Kruvi lävepakule		2	4.5x65	
TL4		Door handle fittings - Türgriff - Poignée de porte - Maniglie - Deurhendel / klink - Ukse käepide VU		1		
TL5		Set of door lock covers - Schlossblenden - Set de garnitures de porte - Copertura serrature - Slot sluitplaat set - Ukse lukuplaat		1		
		Cylinder lock - Zylinderschloss - Barillet de porte - Serratura - Cylinder slot - Ukse lukusüdamik		1	30x35	
		Male bolt hinge for door - Türband - Partie male de paumelle de porte - Cerniera anube x porta - Scharnier bout - Ukse polthing isane		3		