

Nele 5
Art. Nr. 409900
1/i

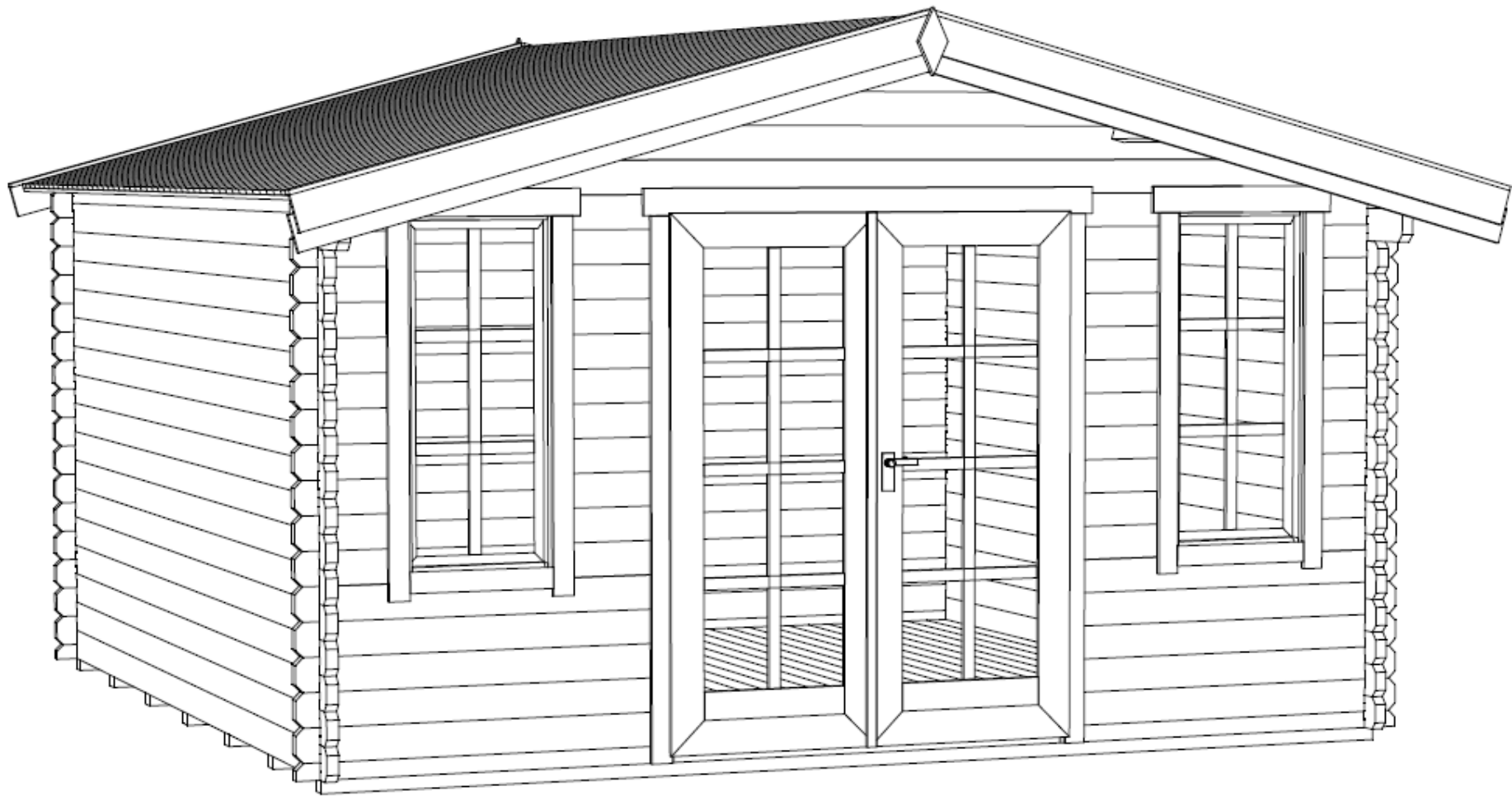

23.02.2017

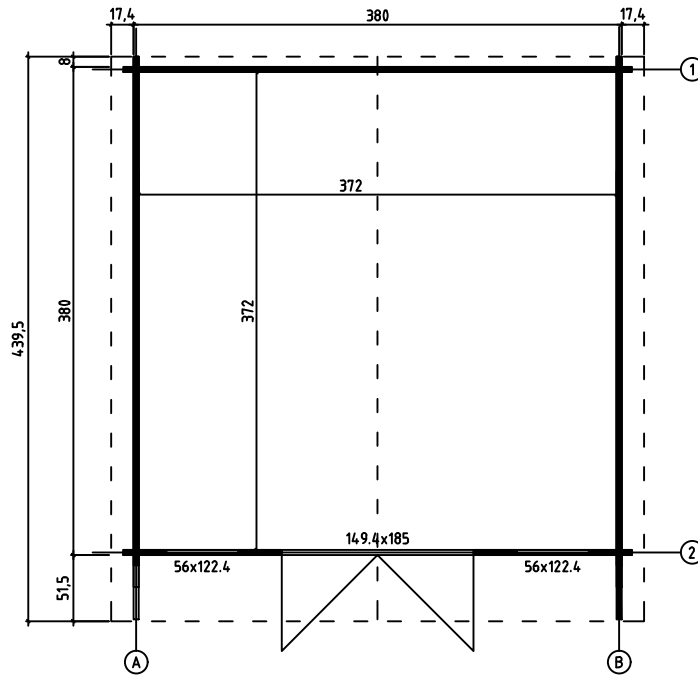

FOUNDATION - FUNDAMENT - FONDATION

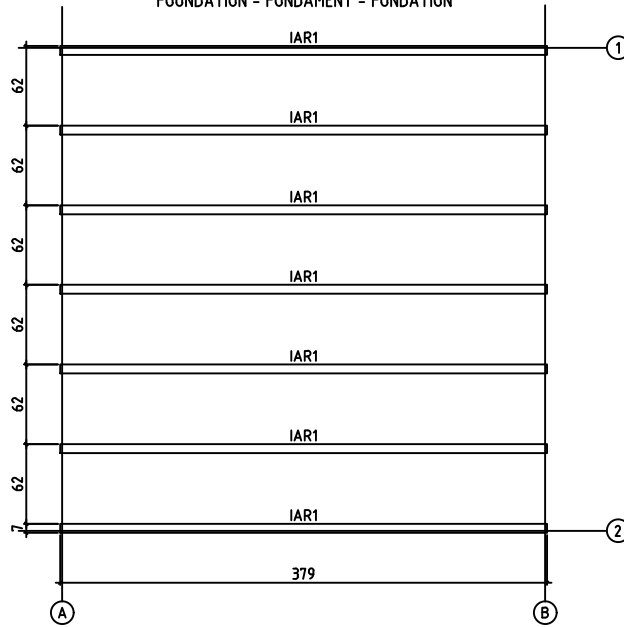

FLOOR BOARDS - FUSSBODENBRETTER - PLAN POSE PLANCHER

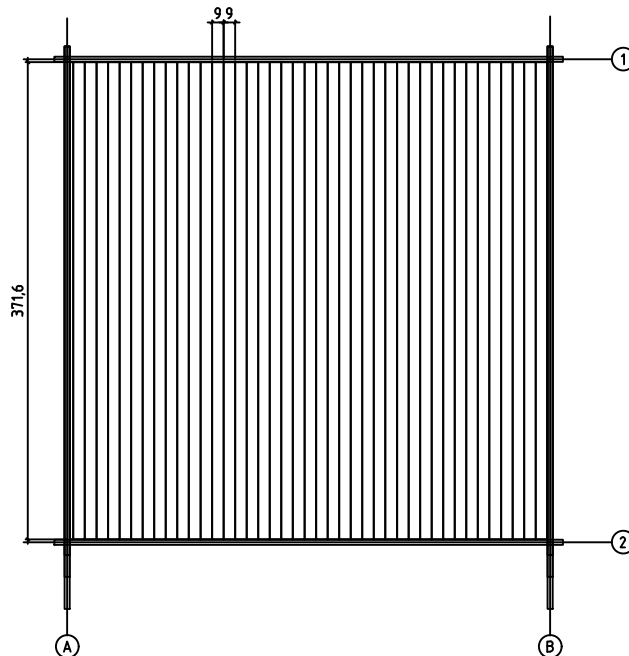



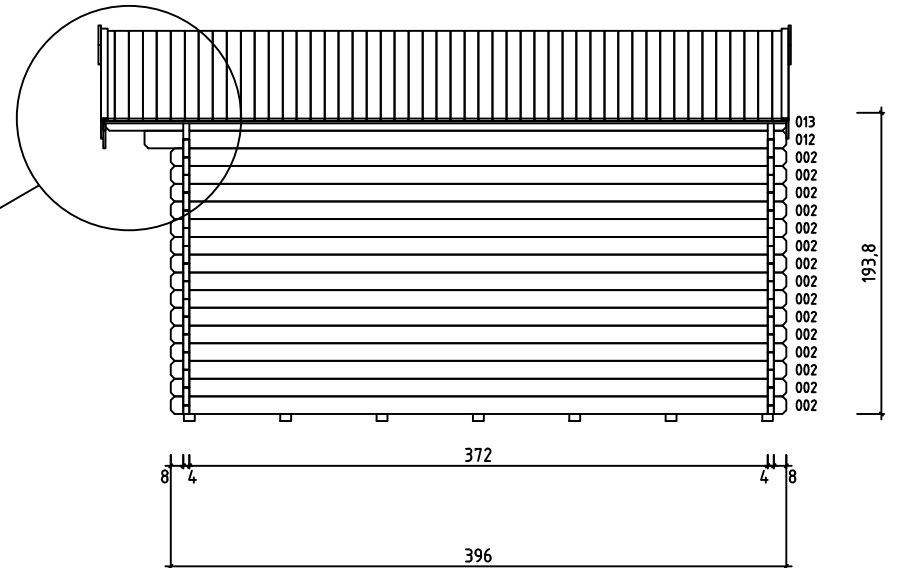
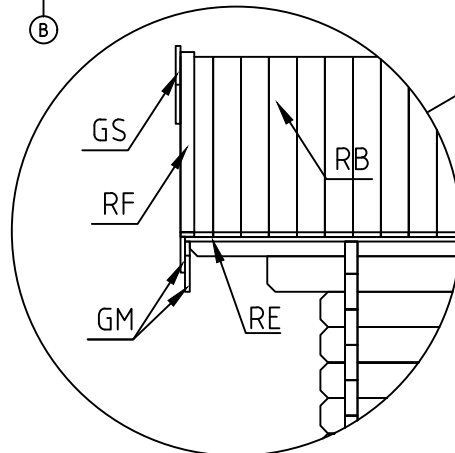
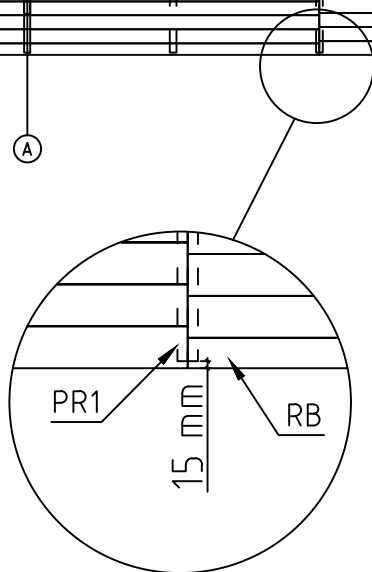
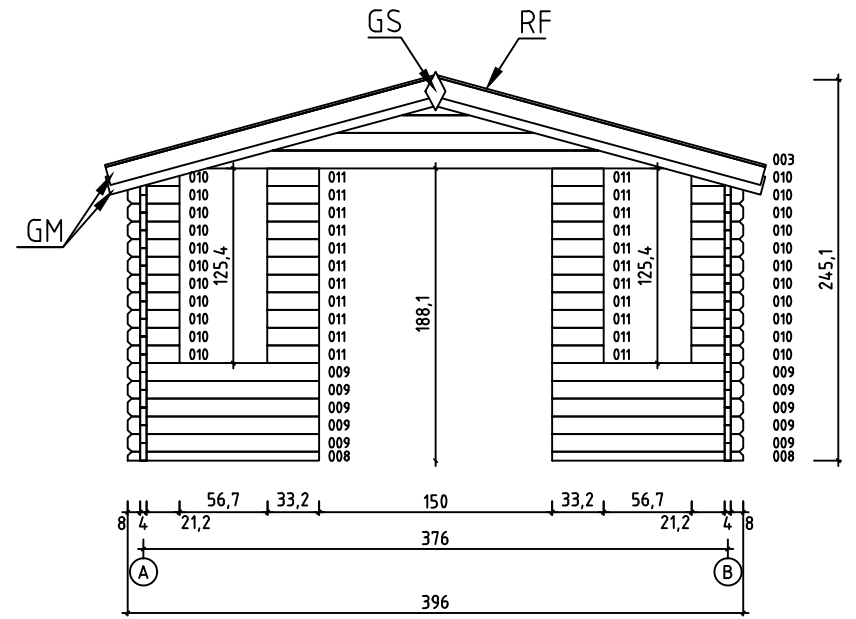
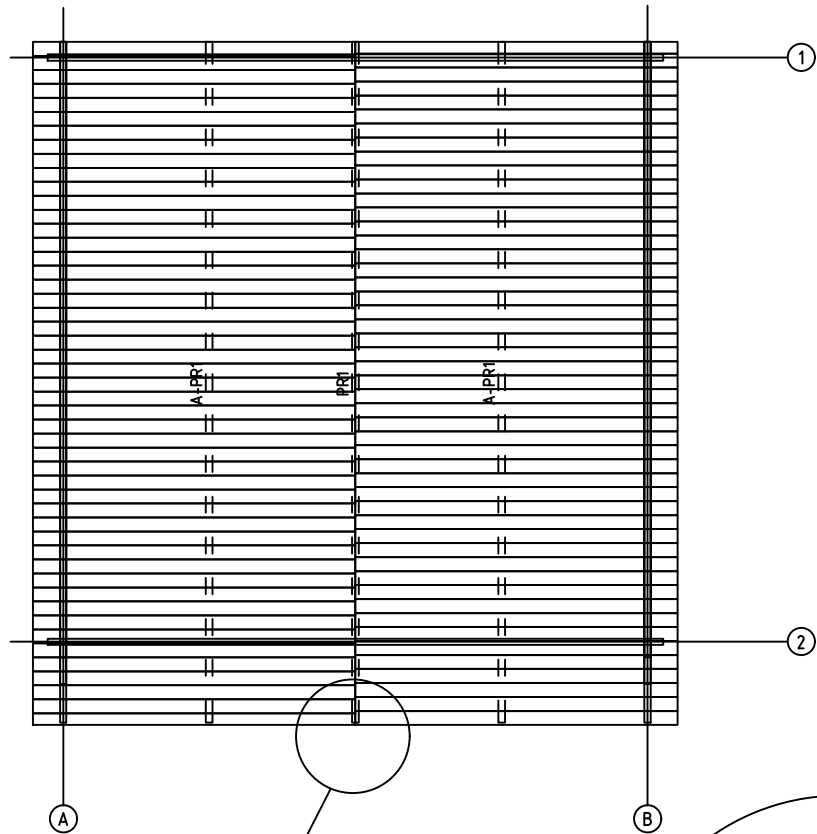

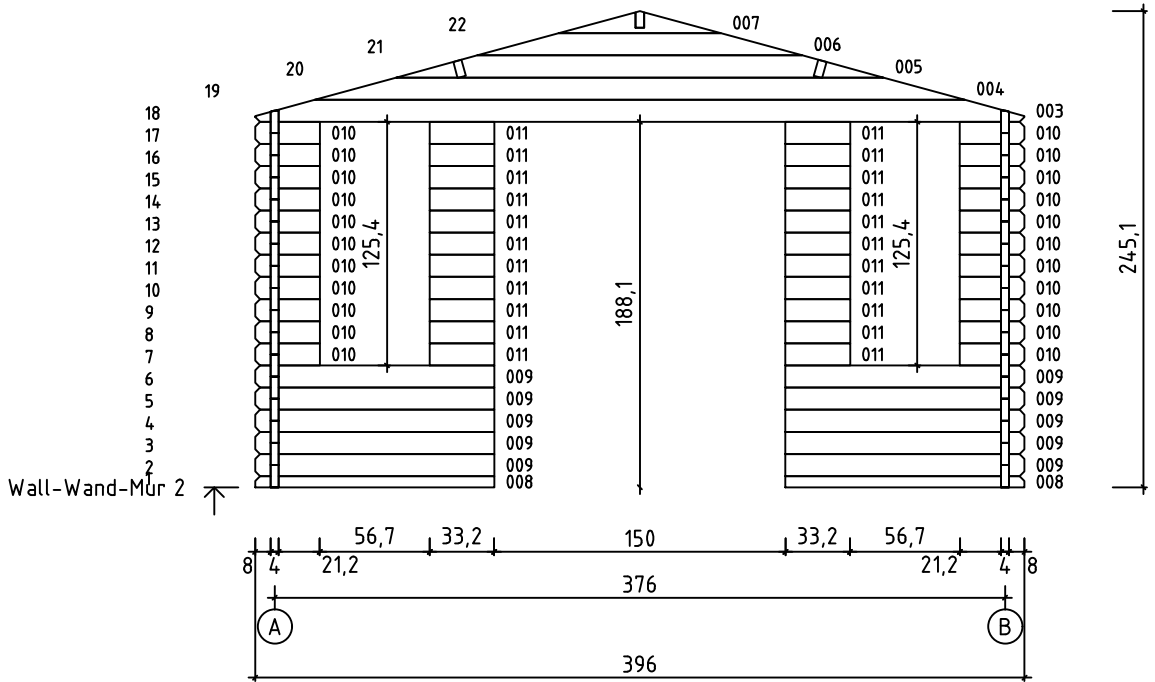
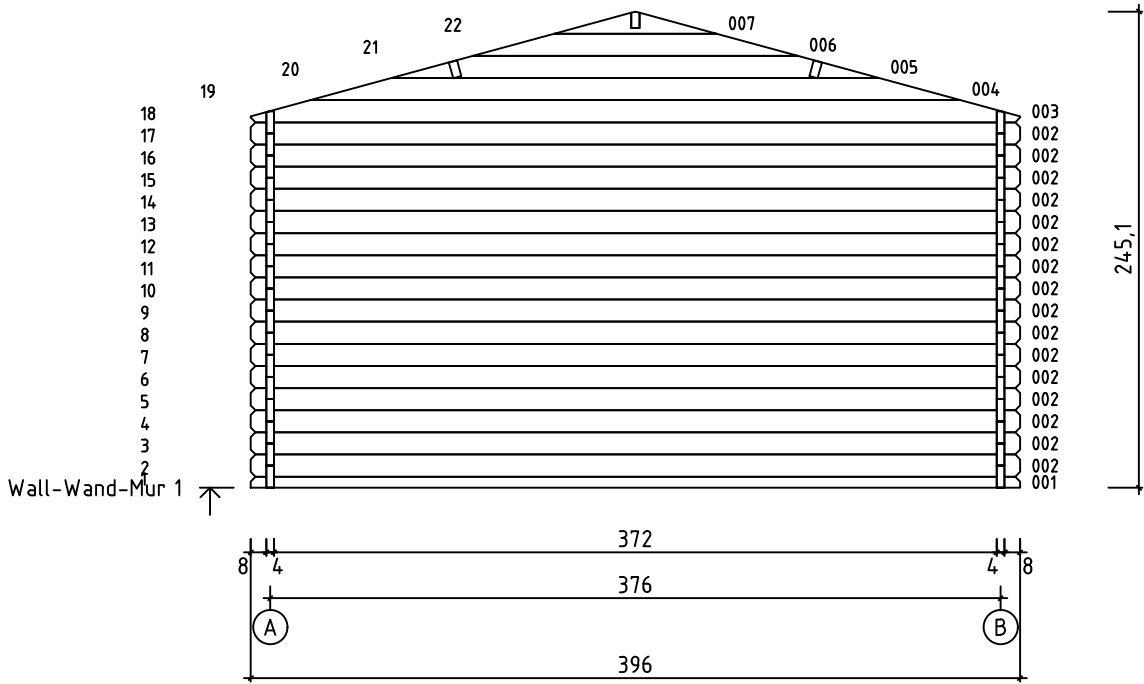

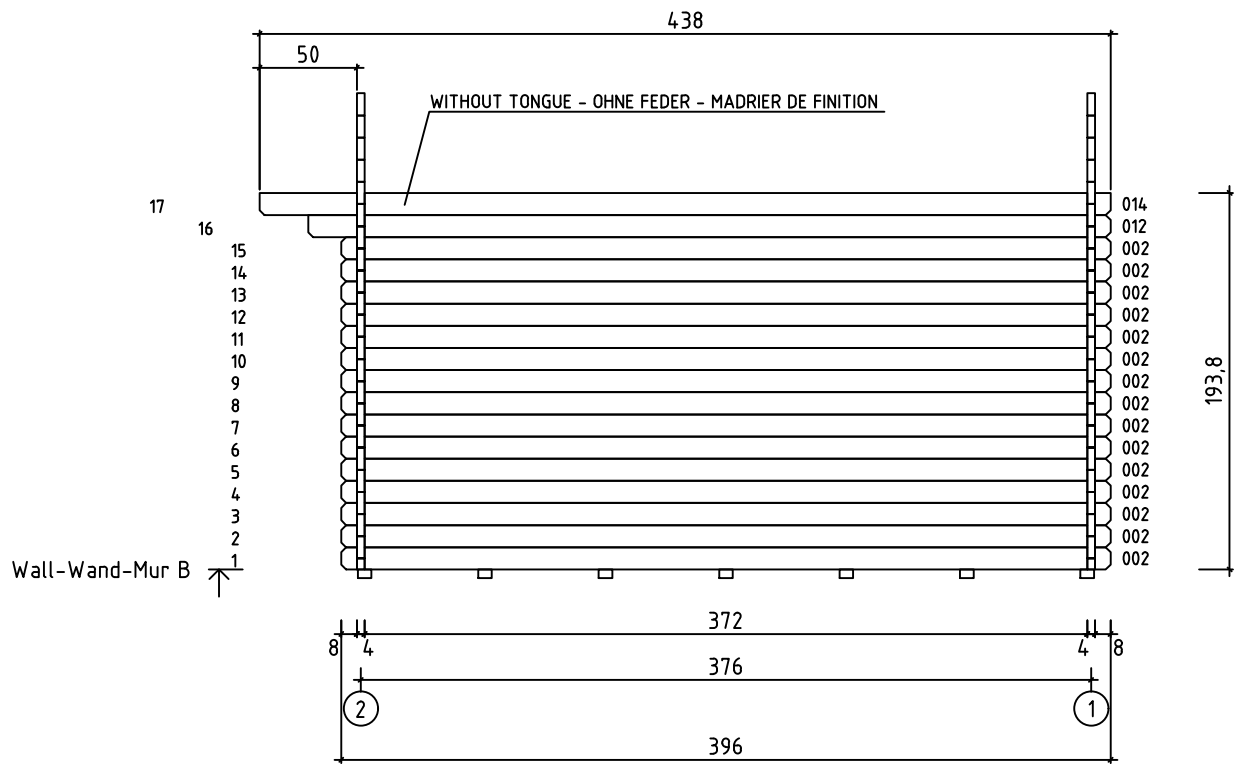
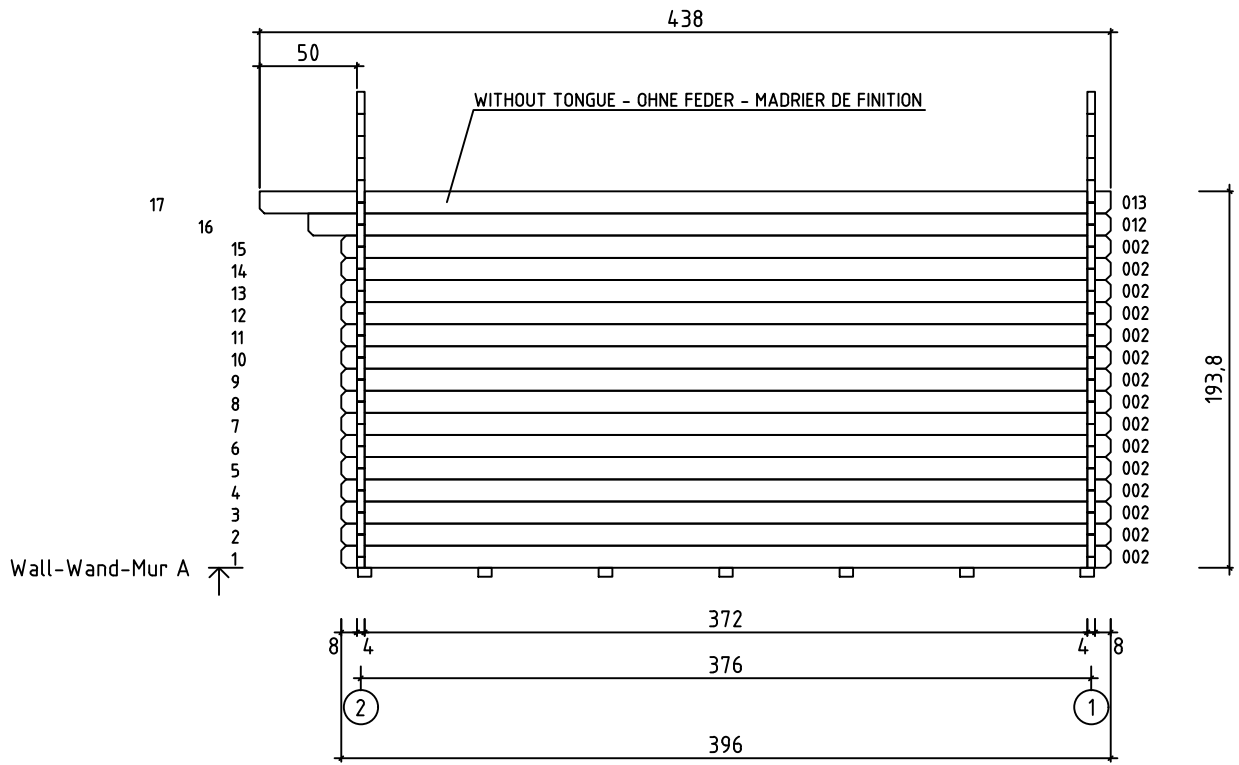

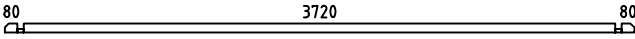
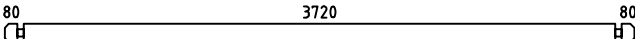
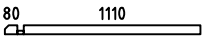
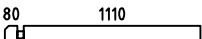

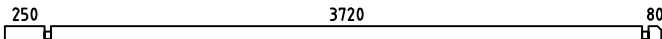
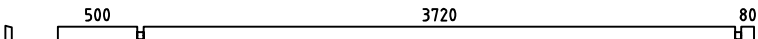
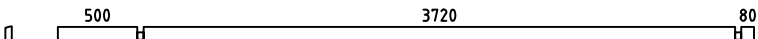
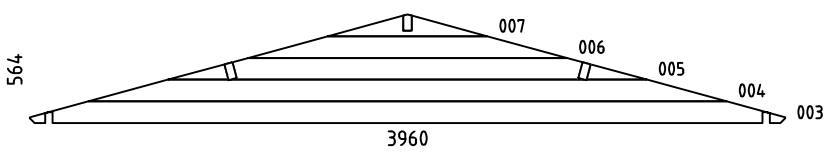
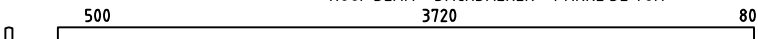
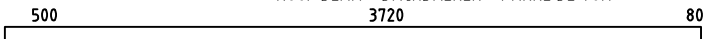



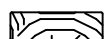
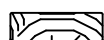
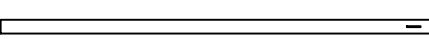
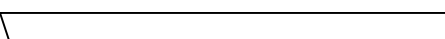

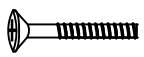



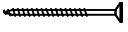
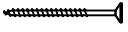
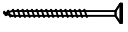
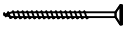
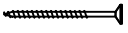
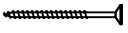
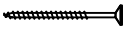

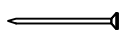
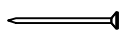

ART.NR. 409900
 ROOF PLAN - DACH-PLAN - PLAN DU TOIT

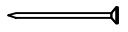

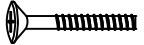

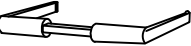

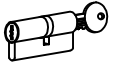
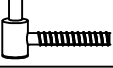
Pos	23.02.2017	Piece list - Stückliste - Liste des pièces Art. nr. 409900	6/8	Q.	P (mm)	L (mm)
001				1	40x57	3960
002				46	40x114	3960
008				2	40x57	1230
009				10	40x114	1230
010				22	40x114	332
011				22	40x114	332
012				2	40x114	4130
013				1	40x120	4380
014				1	40x120	4380
W1-1 W2-1				1 1		
IAR1	FOUNDATION - FUNDAMENT - FONDATION			7	70x45	3790
PR1	ROOF BEAM - DACHBALKEN - PANNE DE TOIT			1	44x140	4380
A-PR1	ROOF BEAM - DACHBALKEN - PANNE DE TOIT			2	44x140	4380
	FLOOR BOARDS - FUSSBODENBRETTER - LAME DE PLANCHER			42	90x18	3716
RB	ROOF BOARDS - DACHBRETTER - VOLIGES			98	90x15	2150
	FLOOR FILLET-FUSSBODENLEISTE - CORNIERE DE FINITION DU PLANCHER				18x18	14.86
RF	ROOFING FELT FILLET - DACHPAPPENLEISTE - BAGUETTE DE FIXATION DU FEUTRE BITUMEUX			4	15x45	2200
RE	ROOF EDGE REINFORCEMENT - DACHRANDVERSTÄRKUNG - CORNIERE DE RENFORT DE BORD DE TOIT			2	15x45	4395
	STORM PROTECTION - STURMLEISTE - LATTE ANTI-TEMPETE			4	22x45	2050
GM	GABLE MOULDING - GIEBELLEISTE - PLANCHE DE RIVE			6	15x120	2200
	WINDOW HANDLE FITTINGS-FENSTERGRIFF - POIGNÉE D'OUVERTURE DE FENETRE			2		
	BOLT FOR WINDOW HANDLE FITTINGS - BOLZEN FÜR FENSTERGRIFF BESCHLAG - BOULON POUR POIGNÉE D'OUVERTURE DE FENETRE			4		
	SCREW FOR GABLE SEGMENT - SCHRAUBEN FÜR DECKBLATT - VIS POUR FIXATION LOSANGE DE FINITION			4	3.5x35	

Pos	23.02.2017	Piece list - Stückliste - Liste des pièces Art. nr. 409900	7/8	Q.	P (mm)	L (mm)
		SCREW FOR GABLE MOULDING - SCHRAUBEN FÜR GIEBELLEISTE - VIS DE FIXATION POUR PLANCHE DE RIVE		36	3.5x50	
		SCREW FOR ROOF EDGE REINFORCEMENT - SCHRAUBEN FÜR DACHRANDVERSTÄRKUNG - VIS POUR RENFORT DE BORD DE TOIT		20	3x30	
		SCREW FOR DOOR FILLET - SCHRAUBE ZUR BEFESTIGUNG TÜRLEISTE - VIS D'ASSEMBLAGE DU CADRE DE PORTE		5	3x30	
		SCREW FOR ROOF BEAMS - SCHRAUBEN FÜR DACHBALKEN - VIS POUR PANNE DE TOIT		10	5x120	
		SCREW FOR 1. WALL BEAM - SCHRAUBE FÜR 1. BOHLENREIHE - VIS DE FIXATION DES FONDATIONS		7	5x90	
		SCREW FOR DOOR JAMB - SCHRAUBE FÜR TÜRRAHMEN - VIS DE FIXATION POUR MONTANT DE PORTE		4	5x90	
		SCREW FOR DOORSTEP - SCHRAUBEN FÜR SWELLE - VIS DE FIXATION DU SEUIL DE PORTE		3	4.5x65	
		WINDOW/DOOR CROSS SLOT STRAIGHT (PLASTIC) - FENSTER/TÜREN EISENWAREN - QUINCAILLERIE POUR PORTES ET FENÊTRES		28		
		NAIL FOR WINDOW/DOOR CROSS SLOT STRAIGHT - NÄGEL FÜR FENSTER/TÜREN EISENWAREN - POINTE POUR QUINCAILLERIE POUR PORTES ET FENÊTRES		56	1.4x30	
		ZN NAIL FOR FLOOR FILLET - ZN NÄGEL FÜR FUSSBODENLEISTE - POINTE POUR CORNIERE DE FINITION DU PLANCHER		30	1.4x40	
		HAMMER BLOCK - SCHLAGHOLZ - CALLE DE FRAPPE		1		
		NUT FOR STORM PROTECTION - SCHRAUBENMUTTER FÜR STURMLEISTE - ÉCROU POUR LAME ANTI-TEMPETE		8		
		ZN NAIL FOR ROOF - ZN NÄGEL FÜR DACHBRETTER - POINTE POUR TOIT		308	2x50	
		ZN NAIL FOR FLOOR - ZN NÄGEL FÜR FUSSBODENBRETTER - CLOUS POUR PLANCHER		301	2x50	
		ZN NAIL FOR ROOFING FELT FILLET - ZN NÄGEL FÜR DACHPAPPENLEISTE - POINTE POUR BAGUETTE FIXATION FEUTRE BITUMEUX		24	2x40	
		BOLT FOR STORM PROTECTION - BOLZEN FÜR STURMLEISTE - VIS POUR LAME ANTI-TEMPETE		8		
GS		GABLE SEGMENT-DECKBLATT - LOSANGE DE FINITION		2		
		WASHER FOR STORM PROTECTION - DICHTSCHEIBE FÜR STURMLEISTE - RONDELLE POUR LAME ANTI-TEMPETE		8		
		DOOR HANDLE FITTINGS - TÜRGRIFF - SET DE GARNITURES DE SERRURE DE PORTE		1		
		DOOR LOCK COVER - SCHLOSSBLENDE - GARNITURE DE SERRURE DE PORTE		1		
		CYLINDER LOCK - ZYLINDERSCHLOSS - CYLINDRE DE SERRURE		1		
		MALE BOLT HINGE FOR DOOR - TÜRRIEGEL - PARTIE MALE DE CHARNIERE DE PORTE		6		
		STRIKER FOR BARREL BOLT - HÜLSE FÜR GRENDDELRIEGEL - GACHE AU SOL DU TARGETTE		2		

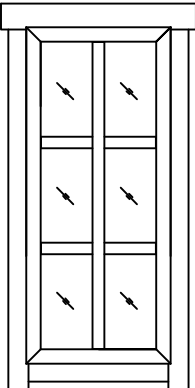
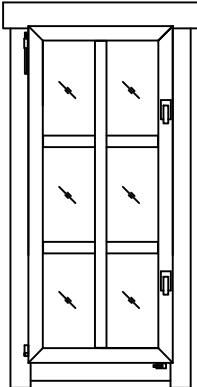
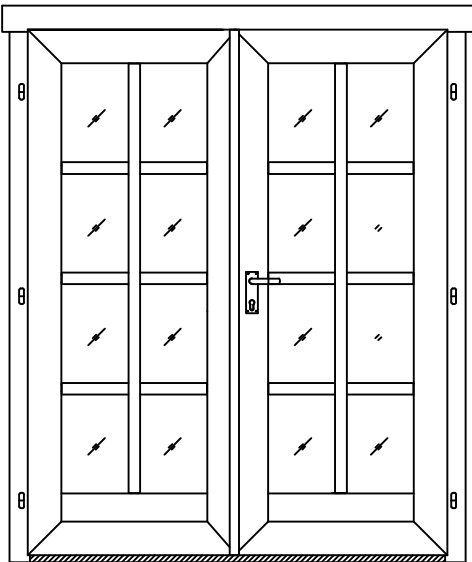
Pos	23.02.2017 Piece list - Stückliste - Liste des pièces Art. nr. 409900	8/8	Q.	P (mm)	L (mm)
	WINDOW - FENSTER - FENETRE 560x1224 AK.1.106.SM0.Pf SGC+E 	1			
	WINDOW - FENSTER - FENETRE 560x1224 AK.1.106.SSV.Pf SGC+E 	1			
	DOOR - TÜR - PORTE 1494x1850 TUK.1.108.SVP.MMPc SGC+E 	1			

+E

