

Art. Nr. 409800  
1/10

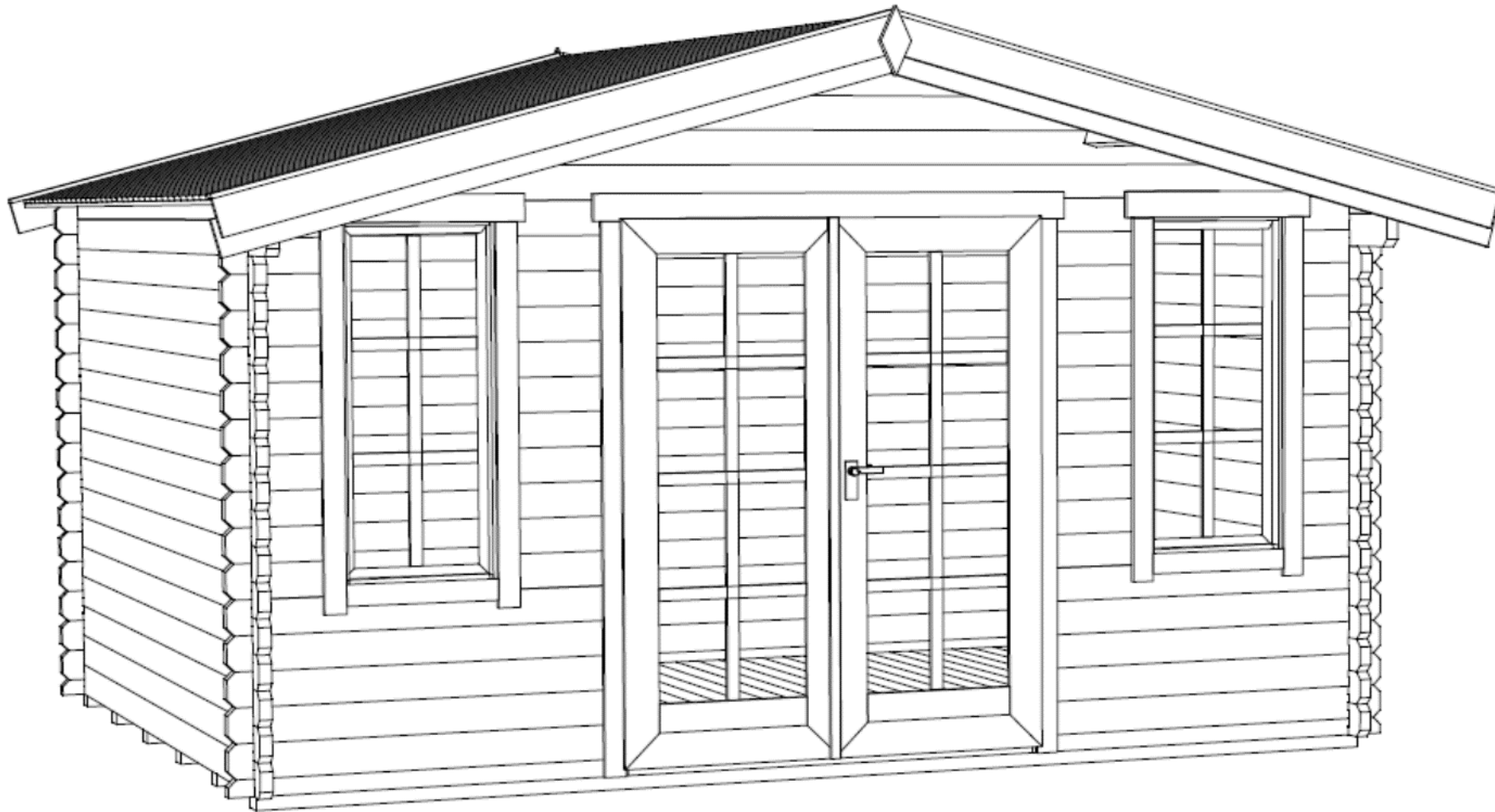

24.07.2014

Groundplan - Grundplan - Plan de masse - Planimetria - Plattegrond - Põhiplaan

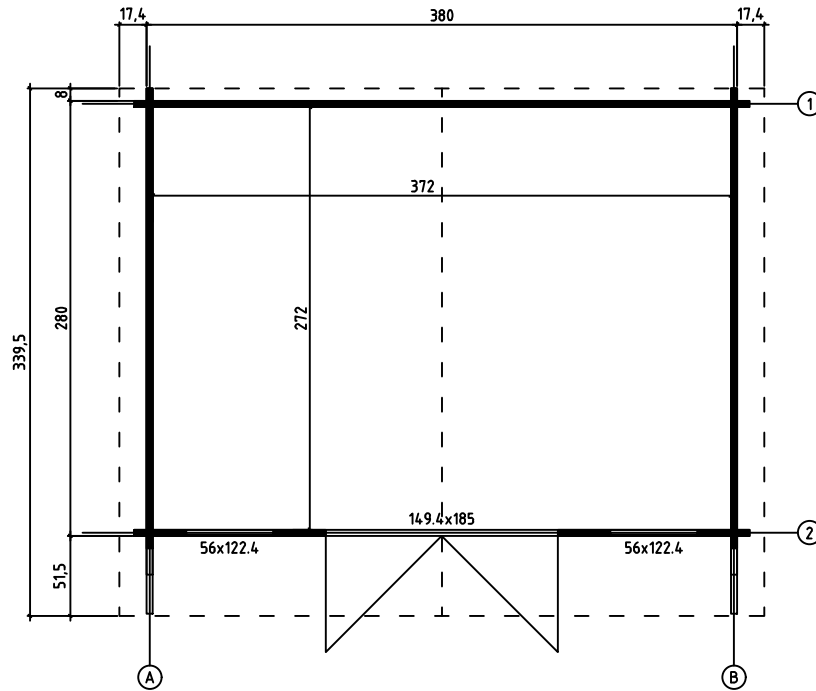

Foundation - Fundament - Fondation - Fondamenta - Fundering - Immutatud alusraam



Floor boards - Fussbodenbretter - Plan pose plancher - Pavimento - Vloerhout - Põrandalaudis

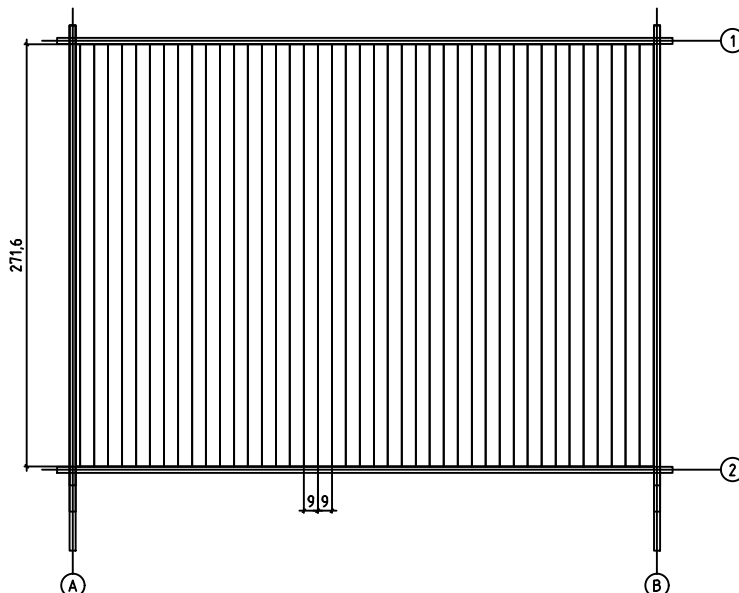





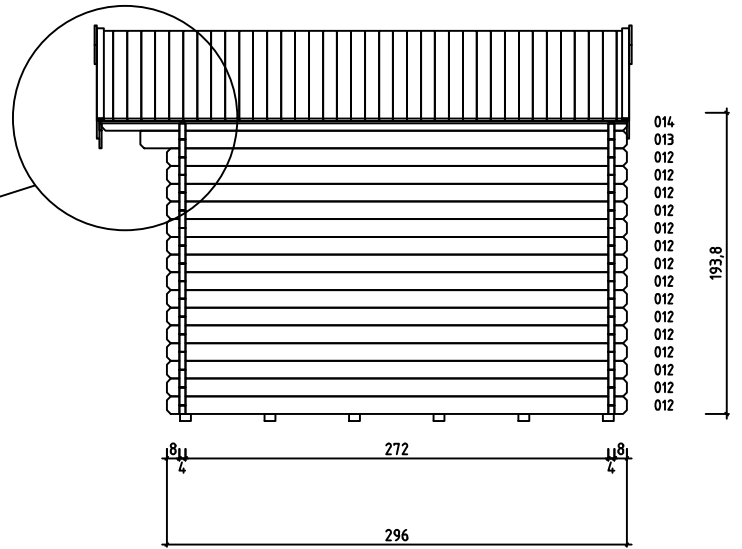
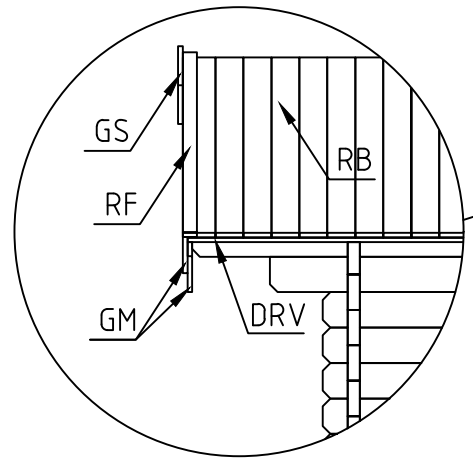
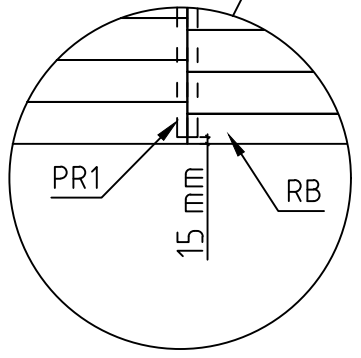
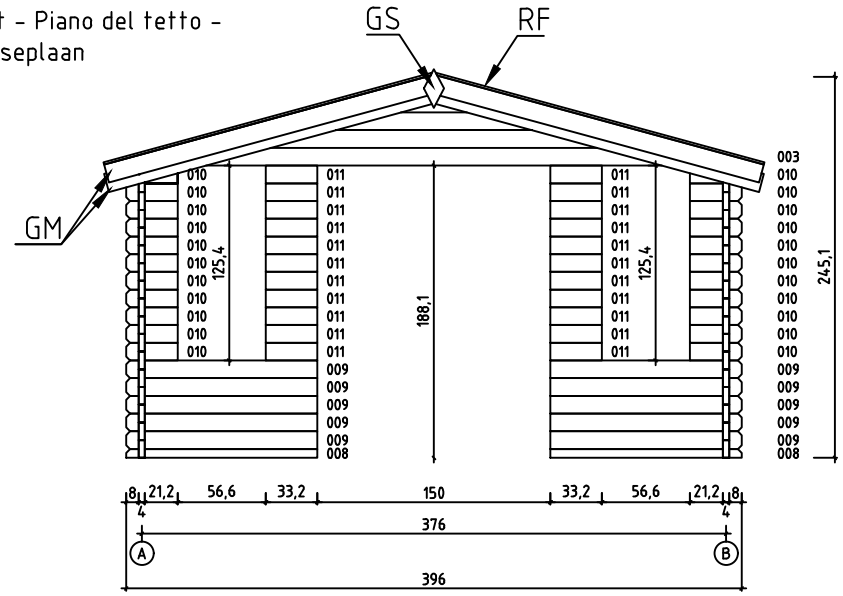
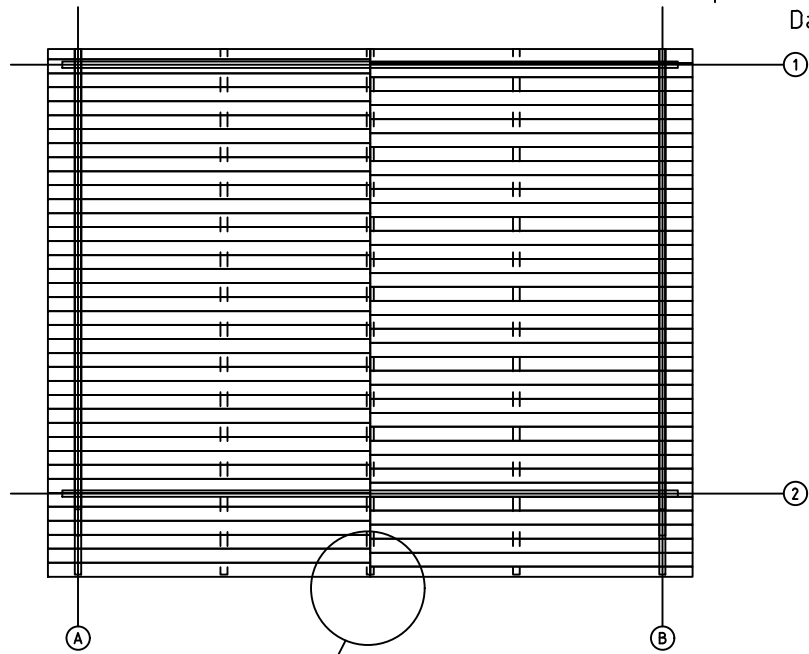

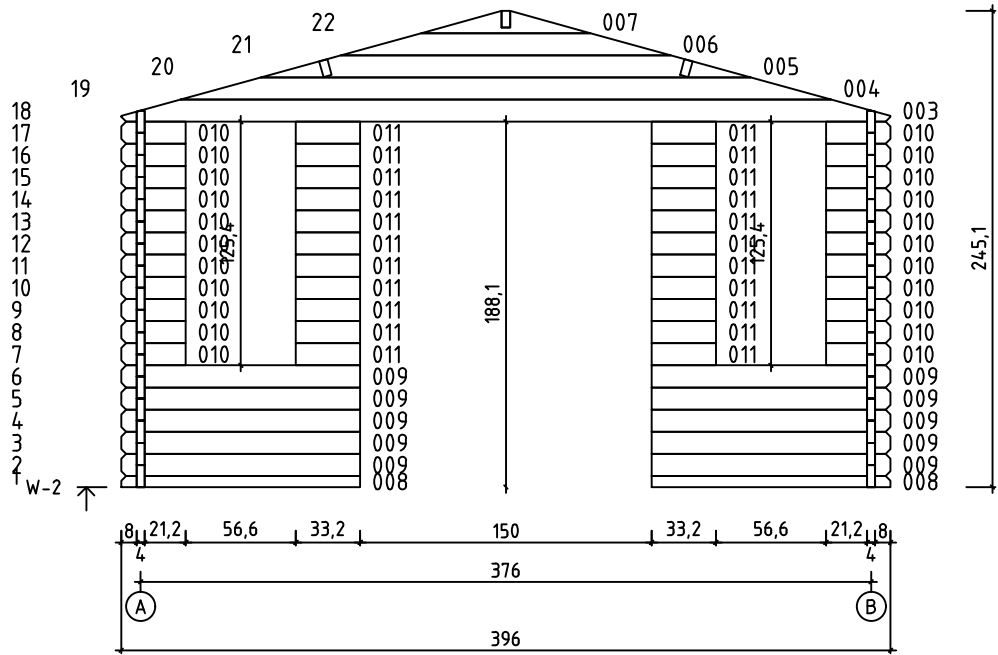
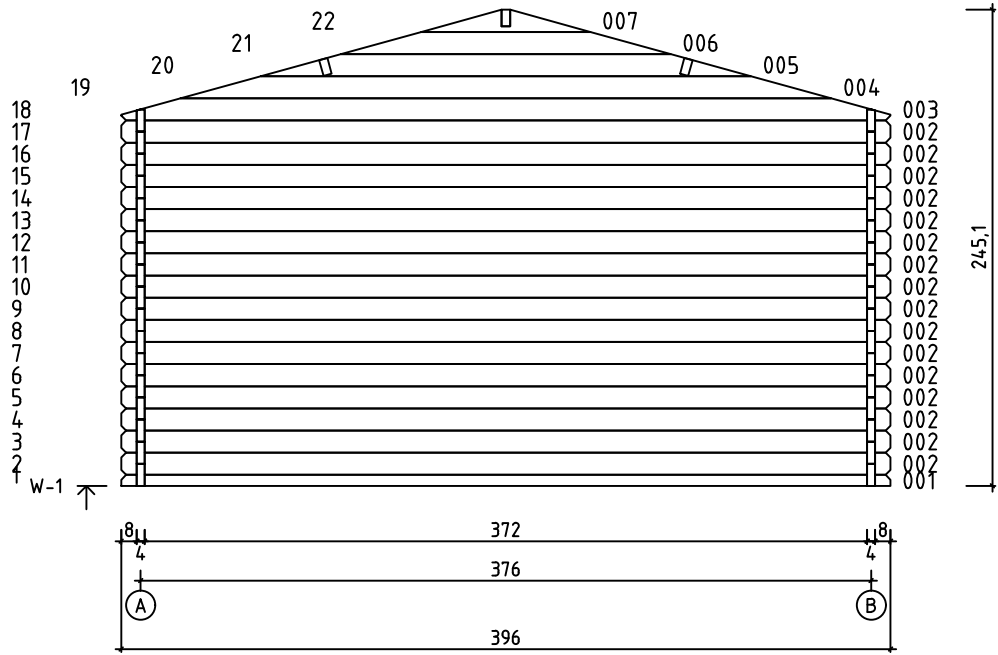

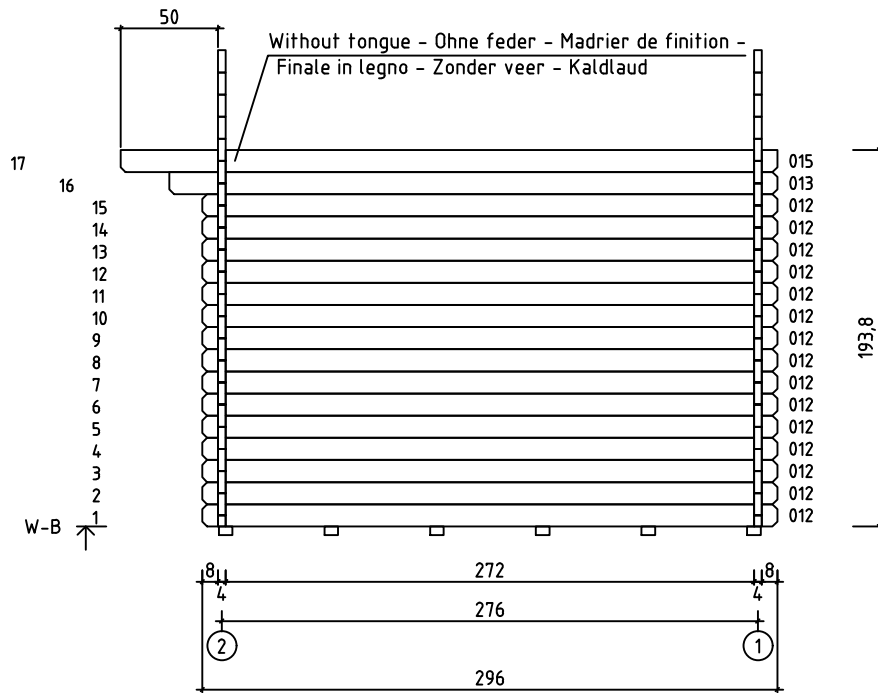
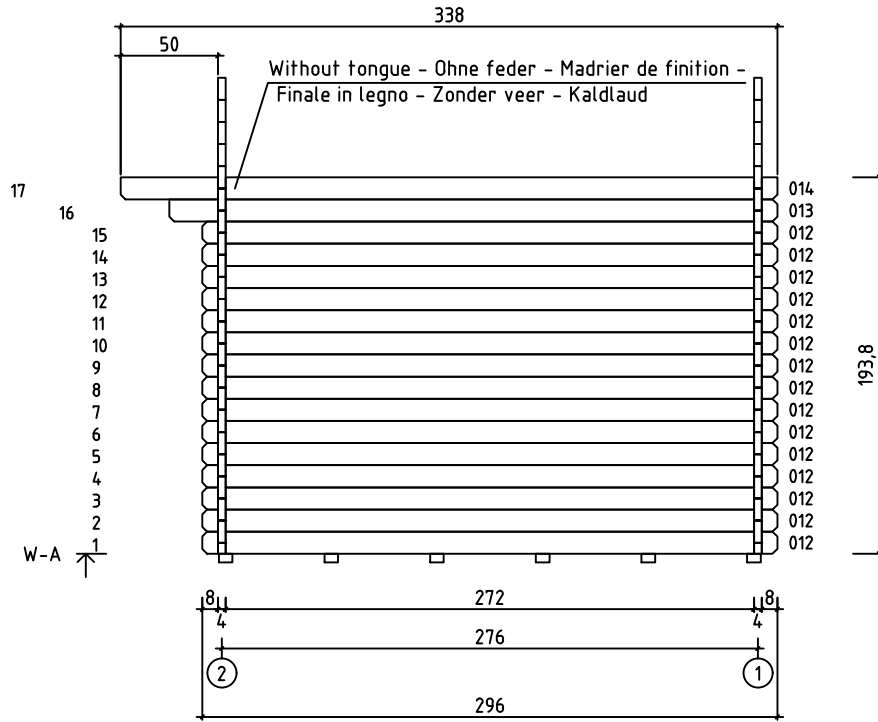

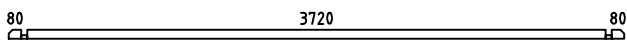
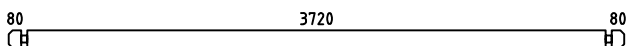
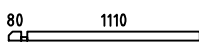
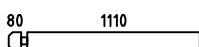
ART.NR. 409800

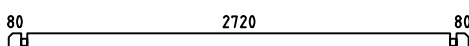
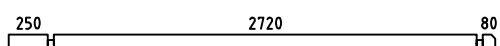
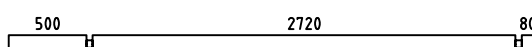
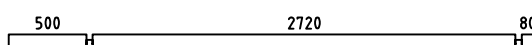
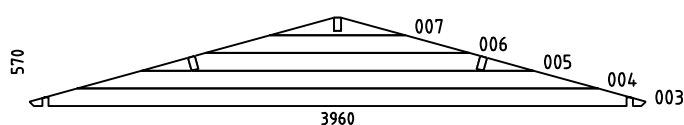
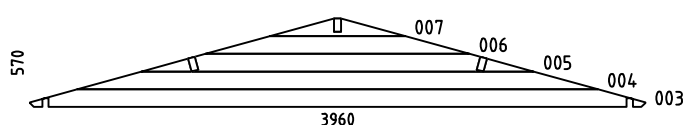
Roof plan - Dach-plan - Plan du toit - Piano del tetto -  
Dak plattegrond - Katuseplaan

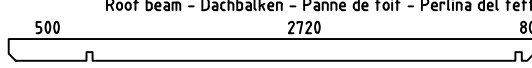





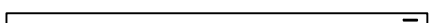
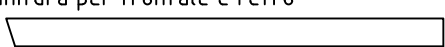



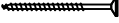
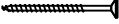
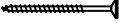

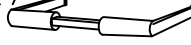

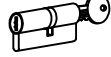
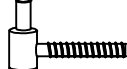

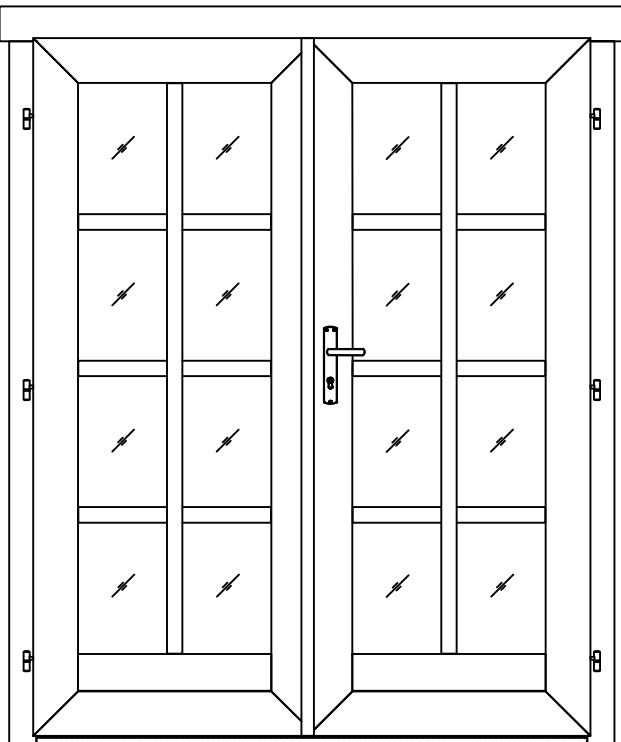
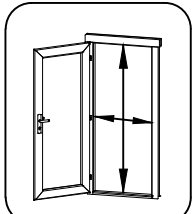

Pos	24.11.2017 Piece list - Stückliste - Liste des pièces - Elementi - Stuklijst - Tükítabel ART.NR. 409800 6/10	Q	P (mm)	L (mm)
001		1	40x57	3960
002		16	40x114	3960
008		2	40x57	1230
009		10	40x114	1230
010		22	40x114	332
011		22	40x114	332
012		30	40x114	2960
013		2	40x114	3130
014		1	40x120	3380
015		1	40x120	3380
W1-1		1		
W2-1		1		
IAR1	Foundation - Fundament - Fondation - Fondamenta - Fundering - Immutatud alusraam 	6	70x45	3790
A-PR1	Roof beam - Dachbalken - Panne de toit - Perlina del tetto - Gordingen / dakbalk - Pärilin 	3	44x140	3380
	Floor boards - Fussbodenbretter - Lame de plancher - Pavimento - Vloerhout - Põrandalaud 	42	90x18	2716
RB	Roof boards - Dachbretter - Voliges - Perlina per tetto - Dakhout - Katuselaud 	76	90x15	2150
	Floor fillet - Fussbodenteiste - Corniere de finition du plancher - Finitura per pavimento (battisco pa) - Vloerafwerklijst - Põrandaliist 		18x18	12.86
RF	Roofing felt fillet - Dachpappenleiste - Baguette de fixation du feutre bitumeux - Asse per fissaggio guaina bituminosa - Afdekljst asfaltpapier - Katusepapiilist 	4	15x45	2200
DRV-1	Roof edge reinforcement - Dachrandverstärkung - Corniere de renfort de bord de toit - Rinforzo x tetto - Dakrand versterking - Räästatugevdus 	2	15x45	3395
KFS-1	Storm protection - Sturmleiste - Latte anti-tempete - Protezione anti vento - Stormverankering / beveiliging - Tormikinnusliist 	4	22x45	2050
GM	Gable moulding - Giebelleiste - Planche de rive - Finitura per frontale e retro del tetto - Gevellijst - Viilulaud 	6	15x120	2200

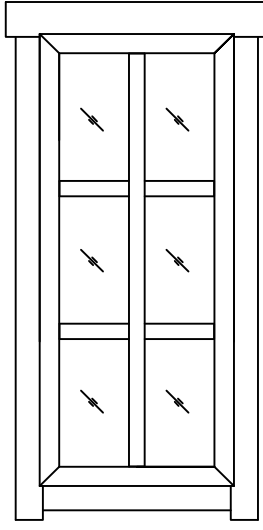

Pos	24.11.2017 Piece list - Stückliste - Liste des pièces - Elementi - Stuklijst - Tükitabel 14.94x1850 TUK.1.108.SVP.MMPc SGC+E 8/10	Q	P (mm)	L (mm)
HS4	Screw for door fillet - Schraube zur befestigung türleiste - Vis pour fixation baguette d'arrêt de porte - Viti per massellino della porta - Schroef voor deurlijst - Kruvi ukse kokkuvältsiliistule 	5	3x30	
HS16	Screw for door jamb - Schraube für türrahmen - Vis de fixation partie haute avec montants du cadre de porte - Viti x fissaggio montanti porte - Schroef voor deurkozijn - Kruvi ukse lengile 	4	5x90	
HS25	Screw for doorstep - Schrauben für swelle - Vis pour fixation barre de seuil - Vite per soglia della porta - Schroef voor deurdorpel - Kruvi lävepakule 	3	4.5x65	
	Window/door cross slot straight (plastic) - Fenster/türen einsewaren - Quincaillerie pour portes et fenetres - Traversa diritta in plastica per finestra o porta - Ramen / deur kruis (rechte sleuf kunststof) - Liistu ristriiv 	16		
NF1	Nail for window/door cross slot straight - Nägel für fenster/türen einsewaren - Pointe pour quincaillerie pour portes et fenetres - Chiodo per scanalatura finestra o porta - Schroef voor deur / raamkruislot (recht) - Liistunael ristriivile 	32	1.4x30	
TL4	Door handle fittings - Türgriff - Poignee de porte - Maniglie - Deurhendel / klink - Ukse käepide VU 	1		
TL5	Set of door lock covers - Schlossblenden - Set de garnitures de porte - Copertura serrature - Slot sluitplaat set - Ukse lukuplaat 	1		
	Cylinder lock - Zylinderschloss - Barillet de porte - Serratura - Cylinder slot - Ukse lukusüdamik 	1		
	Male bolt hinge for door - Türband - Partie male de paumelle de porte - Cerniera anube x porta - Scharnier bout - Ukse polthing isane 	6		
	Striker for barrel bolt - Hülse für grendelriegel - Gache au sol du targette - Boccia per fermo della porta - Huls voor vergrendelingsschuif - Vasturaud ukse servariivile 	2		
Glass size - Glasgröße - Taille de la vitre - Misura del vetro - Glas afmeting - Klaasi mõõt: 514x1486 mm				
		 1394x1766		

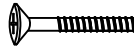

Pos	24.11.2017 Piece list - Stückliste - Liste des pièces - Elementi - Stuklijst - Tükítabel 9/10 560x1224 AK.1.106.SM0.Pf SGC+E	Q	P (mm)	L (mm)
	Window/door cross slot straight (plastic) - Fenster/türen einsenwaren - Quincaillerie pour portes et fenetres - Traversa diritta in plastica per finestra o porta - Ramen / deur kruis (rechte sleuf kunststof) - Liistu ristriiv 	6		
NF1	Nail for window/door cross slot straight - Nägel für fenster/türen einsenwaren - Pointe pour quincaillerie pour portes et fenetres - Chiodo per scanalatura finestra o porta - Schroef voor deur / raamkruisslot (recht) - Liistunael ristriivile 	12	1.4x30	
<p data-bbox="255 324 1284 369">Glass size - Glasgröße - Taille de la vitre - Misura del vetro - Glas afmeting - Klaasi mõõt: 416x1080 mm</p> <div data-bbox="718 425 981 952" style="text-align: center;">  </div>				

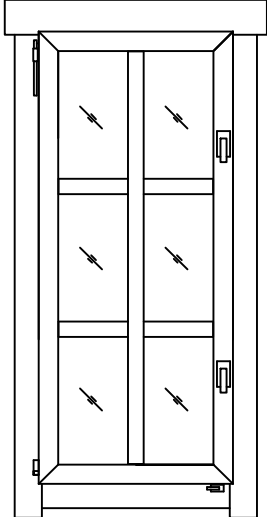
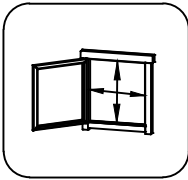
Pos	11.08.2017 Piece list - Stückliste - Liste des pièces - Elementi - Stuklijst - Tükitalabel 560x1224 AK.1.106.SSV.Pf SGC+E	10/10	Q	P (mm)	L (mm)
FS1	Window handle fittings - Fenstergriff - Poignée de fenetre - Maniglia c/ferramenta - Raamhendel -/grendel -/klink - Aknalink		2		
FSP	Bolt for window handle fittings - Bolzen für fenstergriff beschlag - Vis pour fixation poignée de fenetre - Bullone x apertura manuale finestra - Schroef voor raamhendel - Akna käepideme polt		4		
	Window/door cross slot straight (plastic) - Fenster/türen einsenwaren - Quincaillerie pour portes et fenetres - Traversa diritta in plastica per finestra o porta - Ramen / deur kruis (rechte sleuf kunststof) - Liistu ristriiv		6		
NF1	Nail for window/door cross slot straight - Nägel für fenster/türen einsenwaren - Pointe pour quincaillerie pour portes et fenetres - Chiodo per scanalatura finestra o porta - Schroef voor deur / raamkruisslot (recht) - Liistunael ristriivile		12	1.4x30	
<p>Glass size - Glasgröße - Taille de la vitre - Misura del vetro - Glas afmeting - Klaasi mõõt: 416x1080 mm</p> 		 <p>460x1124 mm</p>			

+E

