

*Bike Shelters 2600*

*Art. Nr. 288600*

*1/7*

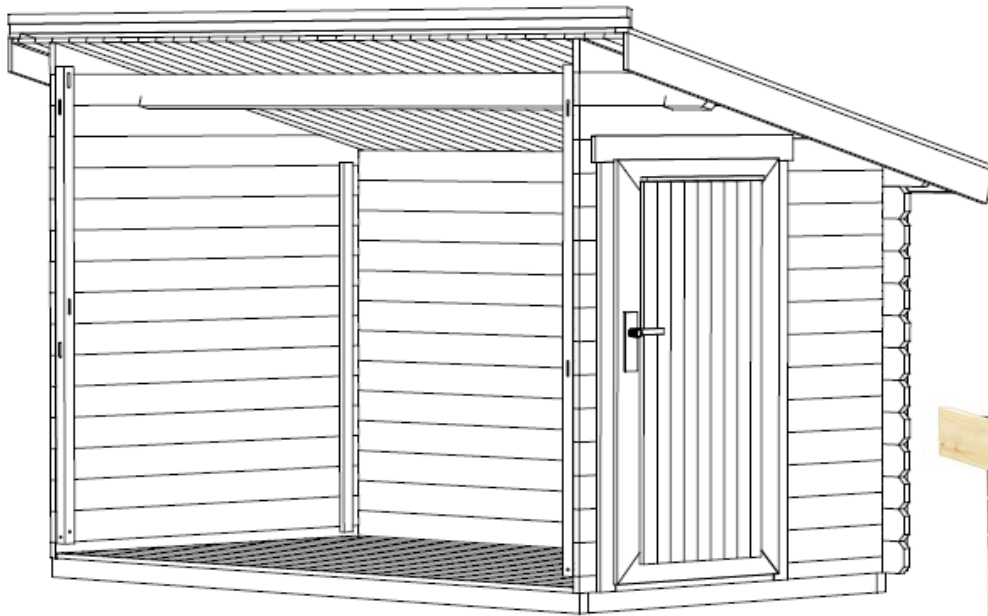

Art.Nr. 288600

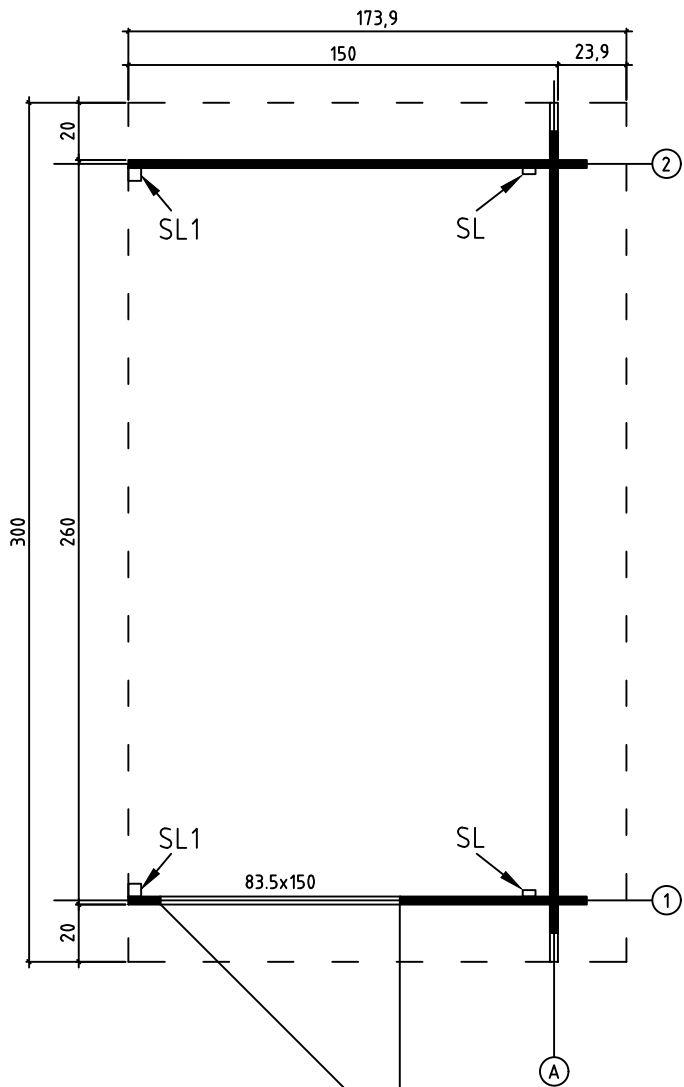

GROUNDPLAN - GRUNDPLAN - PLAN DE MASSE

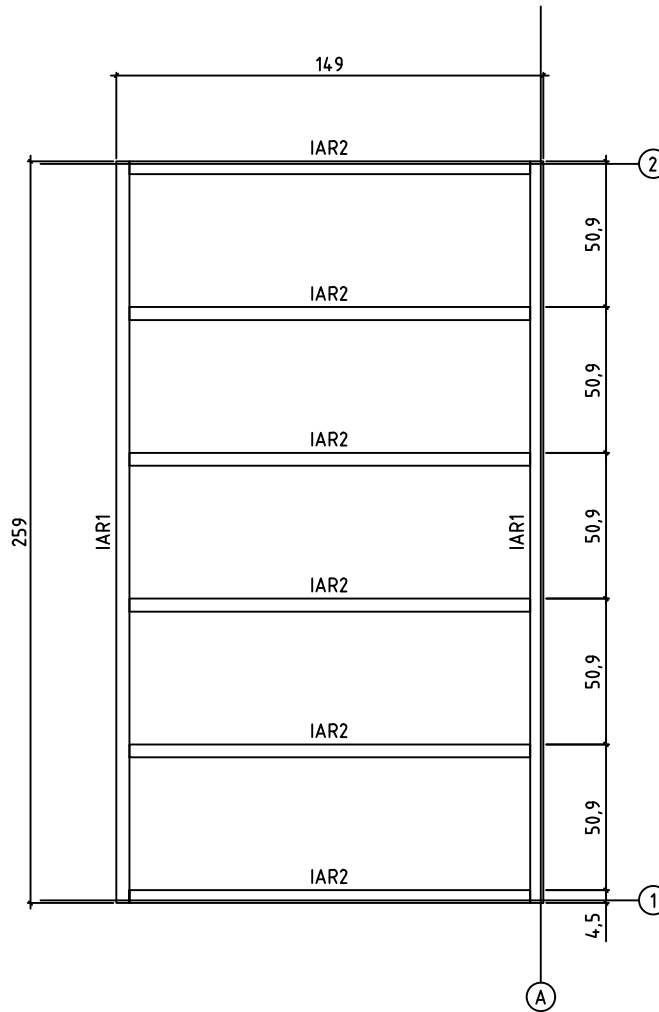

FOUNDATION - FUNDAMENT - FONDATION

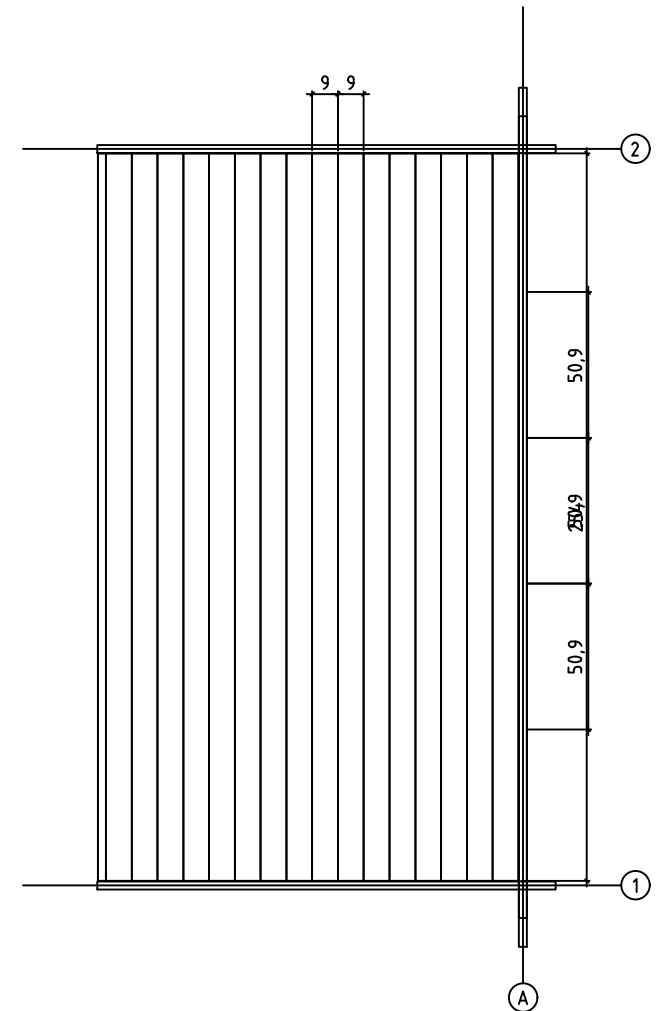

FLOOR BOARDS - FUSSBODENBRETTER - PLAN POSE PLANCHER

Art.Nr. 288600

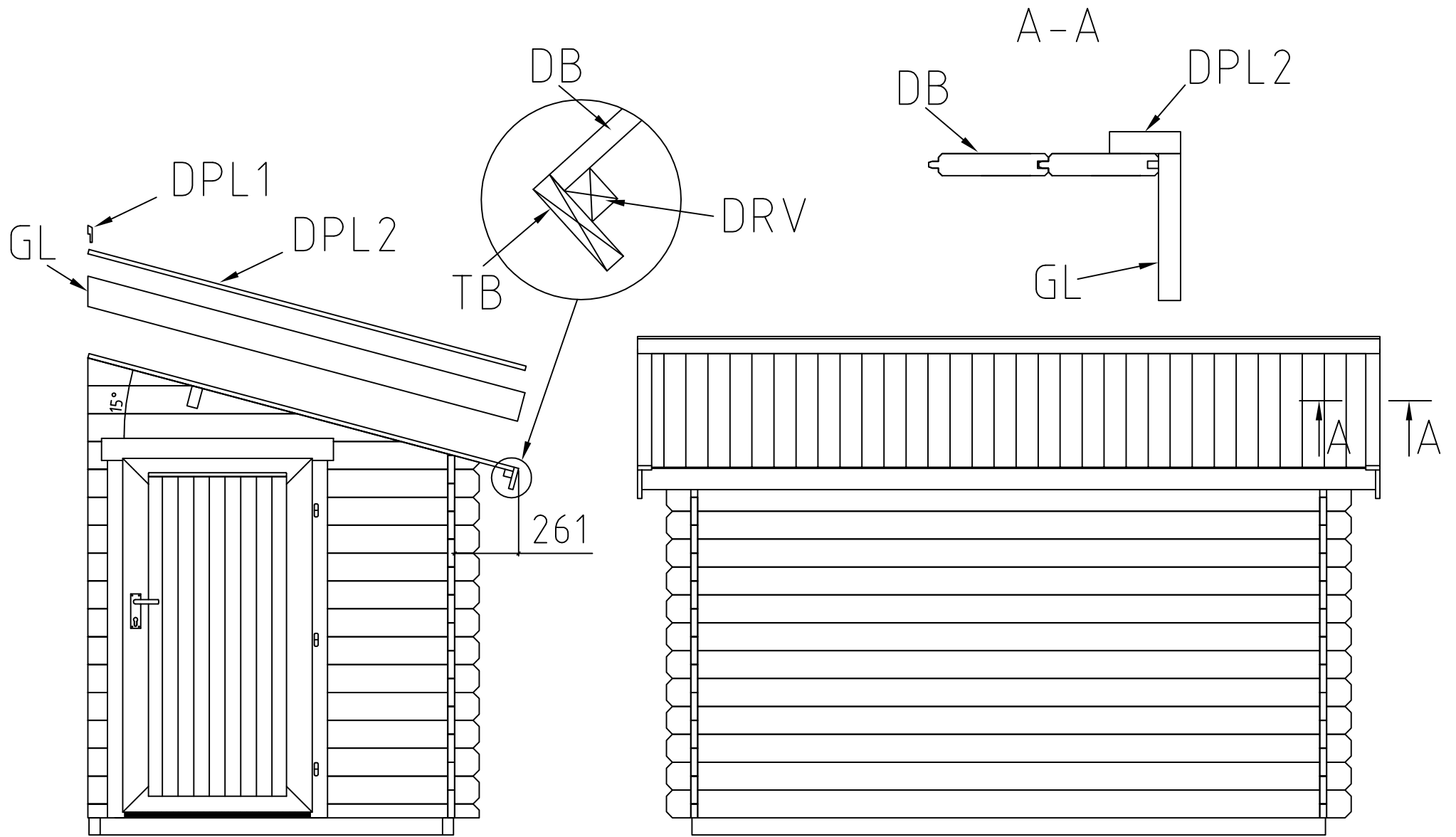

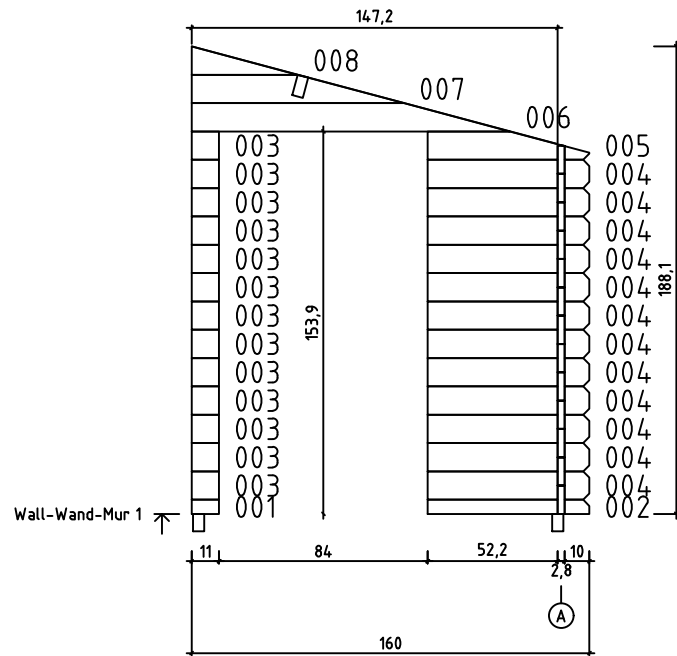

Art.№. 288600

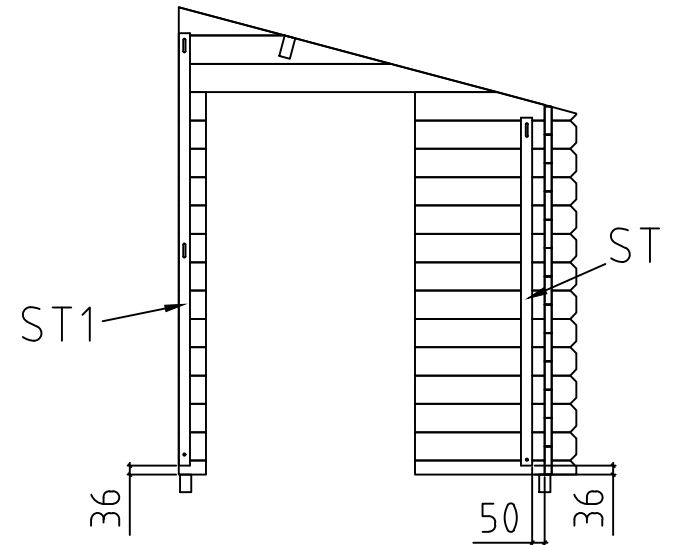
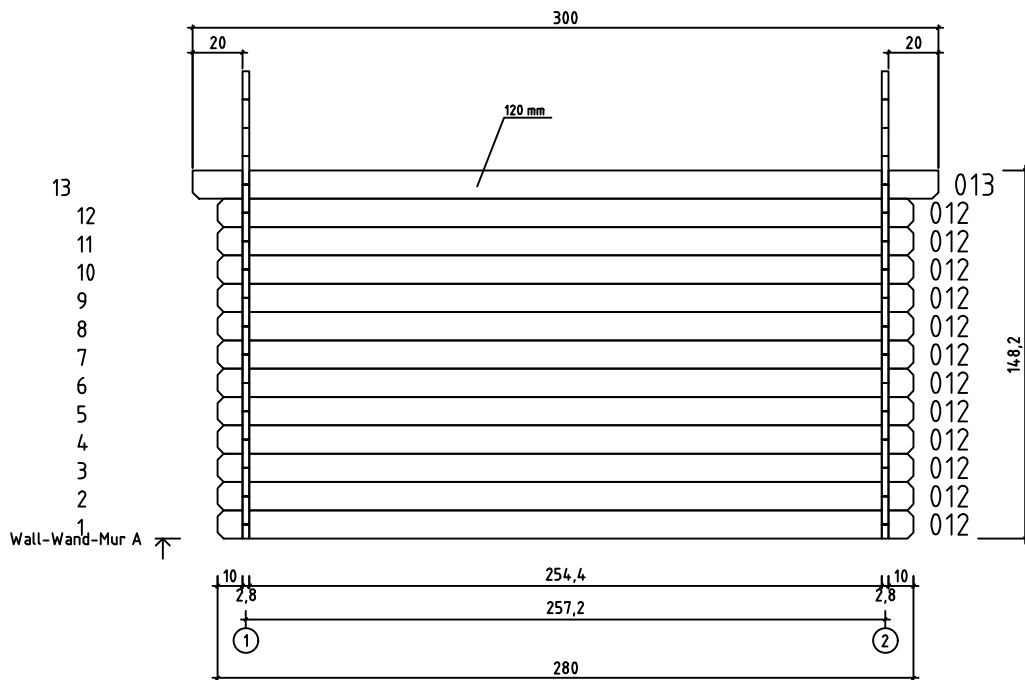
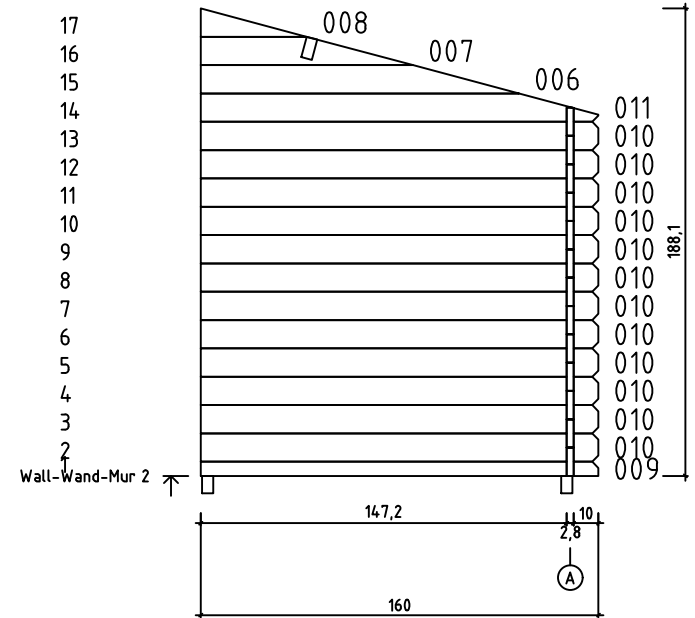



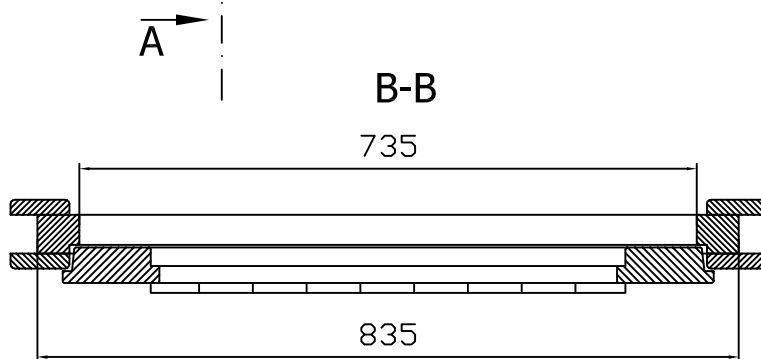
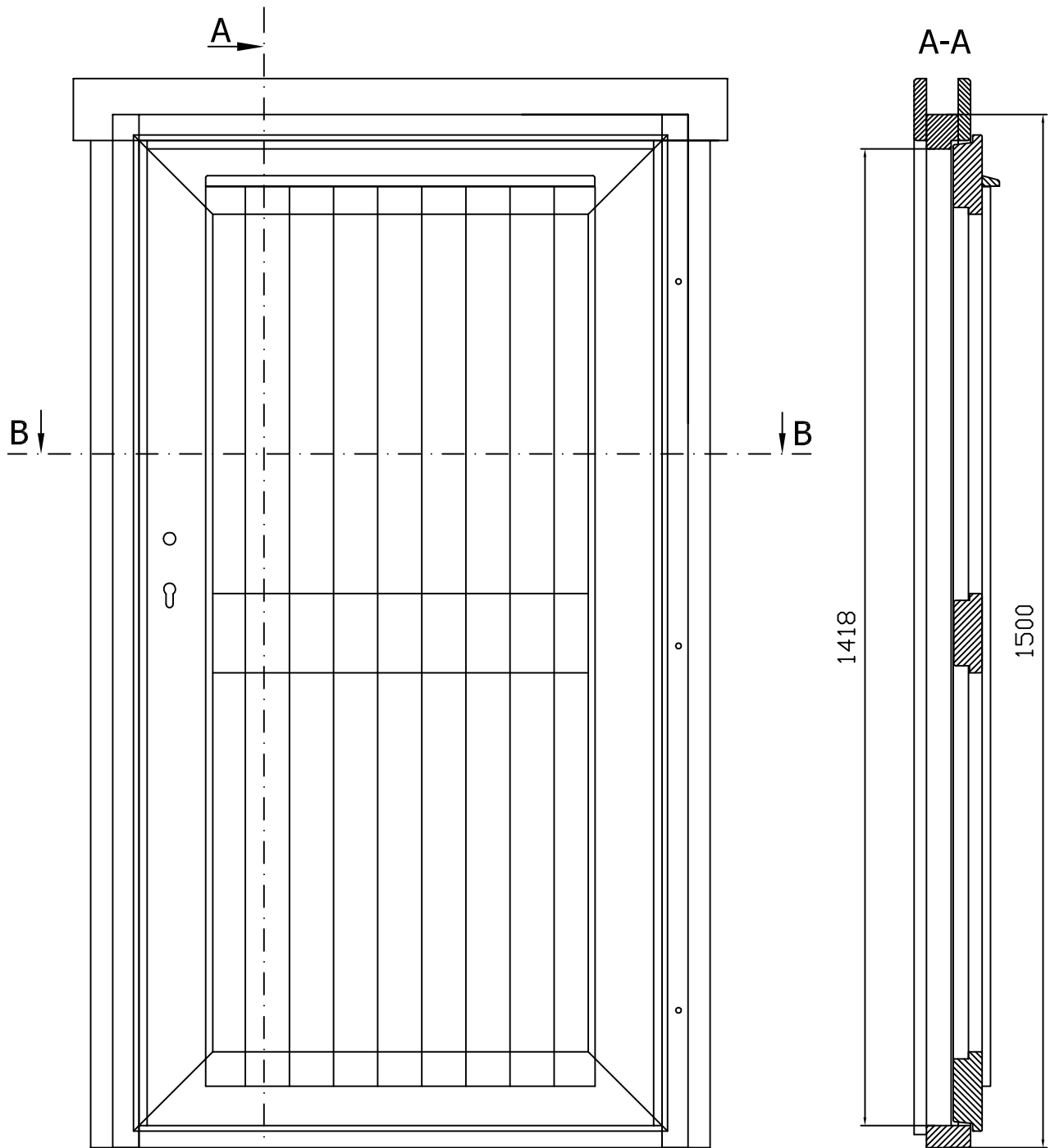









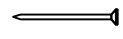
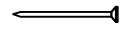

Art.Nr. 288600

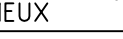
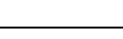
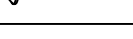
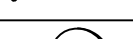

09.06.2016

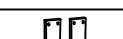
5/7

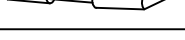
Pos	09.06.2016	Piecelist - Stücklist - Liste des composants Art.Nr. 288600	6/7	Q.	P. (mm)	L. (mm)
001				1	28x57	110
002				1	28x57	650
003				12	28x114	110
004				12	28x114	650
009				1	28x57	1600
010				12	28x114	1600
012				12	28x114	2800
013				1	28x120	3000
W1-1				1		
W2-1				1		
IAR1		FOUNDATION - FUNDAMENT - FONDATION		2	45x70	2590
IAR2		FOUNDATION - FUNDAMENT - FONDATION		6	45x70	1400
APR1		ROOF BEAM - DACHBALKEN - PANNE DE TOIT		1	44x120	3000
	FLOOR BOARDS - FUSSBODENBRETTER - LAME DE PLANCHER			17	18x90	2540
DB	ROOF BOARDS - DACHBRETTER - VOLIGES			34	18x90	1800
	FLOOR FILLET-FUSSBODENLEISTE - CORNIERE DE FINITION DU PLANCHER				18x18	8.02
DPL1	ROOFING FELT FILLET - DACHPAPPENLEISTE - BAGUETTE DE FIXATION DU FEUTRE BITUMEUX			1	18x70	3036
DPL2	ROOFING FELT FILLET - DACHPAPPENLEISTE - - BAGUETTE DE FIXATION DU FEUTRE BITUMEUX			2	18x58	1850
TB	EAVES BOARD - TRAUFBRETT - BANDEAU DE TOIT			1	18x90	3000
DRV	ROOF EDGE REINFORCEMENT - DACHRANDVERSTÄRKUNG - - CORNIERE DE RENFORT DE BORD DE TOIT			1	28x34	3000
ST	STORM PROTECTION - STURMLEISTE - - LATTE ANTI-TEMPETE			2	22x45	2050
ST1	STORM PROTECTION - STURMLEISTE - - LATTE ANTI-TEMPETE			2	45x45	1740
GL	GABLE MOULDING - GIEBELLEISTE - - PLANCHE DE RIVE			2	18x120	1850

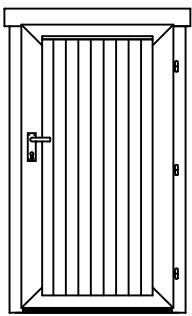
Pos	09.06.2016	Piecelist - Stücklist - Liste des composants Art.Nr. 288600	7/7	Q.	P. (mm)	L. (mm)
SH28	HAMMER BLOCK - SCHLAGHOLZ - CALLE DE FRAPPE 28mm			1		
HS16	SCREW FOR FUNDAMENT - SCHRAUBEN ZUR BEFESTIGUNG FUNDAMENT - - VIS POUR FONDATION			6	5x90	
HS16	SCREW FOR 1. WALL BEAM - SCHRAUBE FÜR 1. BOHLENREIHE - - VIS DE FIXATION DES FONDATIONS			4	5x90	
NF4	ZN NAIL FOR FLOOR - ZN NÄGEL FÜR FUSSBODENBRETTER - - CLOUS POUR PLANCHER			108	2x50	
NF2	ZN NAIL FOR FLOOR FILLET - ZN NÄGEL FÜR FUSSBODENLEISTE - - POINTE POUR CORNIERE DE FINITION DU PLANCHER			16	1.4x40	
HS18	SCREW FOR ROOF BEAMS - SCHRAUBEN FÜR DACHBALKEN - - VIS POUR PANNE DE TOIT			4	5x120	
NF4	ZN NAIL FOR ROOF - ZN NÄGEL FÜR DACHBRETTER - - POINTE POUR TOIT			74	2x50	
HS12	SCREW FOR EAVES BOARDS - SCHRAUBEN FÜR TRAUFBRETTER - - VIS DE FIXATION POUR BANDEAU DE TOIT			7	4x40	
HS12	SCREW FOR ROOF EDGE REINFORCEMENT - SCHRAUBEN FÜR DACHRANDVERSTÄRKUNG - VIS POUR RENFORT DE BORD DE TOIT			7	4x40	
HS9	SCREW FOR GABLE MOULDING - SCHRAUBEN FÜR GIEBELLEISTE - - VIS DE FIXATION POUR PLANCHE DE RIVE			8	3.5x50	
NF5	ZN NAIL FOR ROOFING FELT FILLET - ZN NÄGEL FÜR DACHPAPPENLEISTE - POINTE POUR BAGUETTE FIXATION FEUTRE BITUMEUX			10	2x40	
HS13	SCREW FOR ROOFING FELT FILLET - SCHRAUBEN FÜR DACHPAPPENLEISTE - VIS POUR FIXATION BAGUETTE DE FIXATION FEUTRE BITUMEUX			8	4x60	
BFS	BOLT FOR STORM PROTECTION - BOLZEN FÜR STURMLEISTE - - VIS POUR LAME ANTI-TEMPETE			4	6x60	
BFS	BOLT FOR STORM PROTECTION - BOLZEN FÜR STURMLEISTE - - VIS POUR LAME ANTI-TEMPETE			12	6x100	
DFS	WASHER FOR STORM PROTECTION - DICHTSCHEIBE FÜR STURMLEISTE - - RONDELLE POUR LAME ANTI-TEMPETE			16	D6	
SFS	NUT FOR STORM PROTECTION - SCHRAUBENMUTTER FÜR STURMLEISTE - ÉCROU POUR LAME ANTI-TEMPETE			16	D6	
HS25	SCREW FOR DOORSTEP - SCHRAUBEN FÜR SWELLE - - VIS DE FIXATION DU SEUIL DE PORTE			2	4.5x65	
TL5	SET OF DOOR LOCK COVERS - SCHLOSSBLENDEN - - SET DE GARNITURES DE SERRURE DE PORTE			1		
TL4	DOOR HANDLE FITTINGS-TÜRGRIF - - GARNITURE DE POIGNÉE DE PORTE			1		
	CYLINDER - ZYLINDERSCHLOSS - CYLINDRE DE SERRURE			1	30/35	
	DOOR - TÜR - PORTE 835x1500 TC+0		UL.2.100.IVP.MMWc	1		