

*ELBA 44*  
*ART.NR. 441302*  
*1/14*

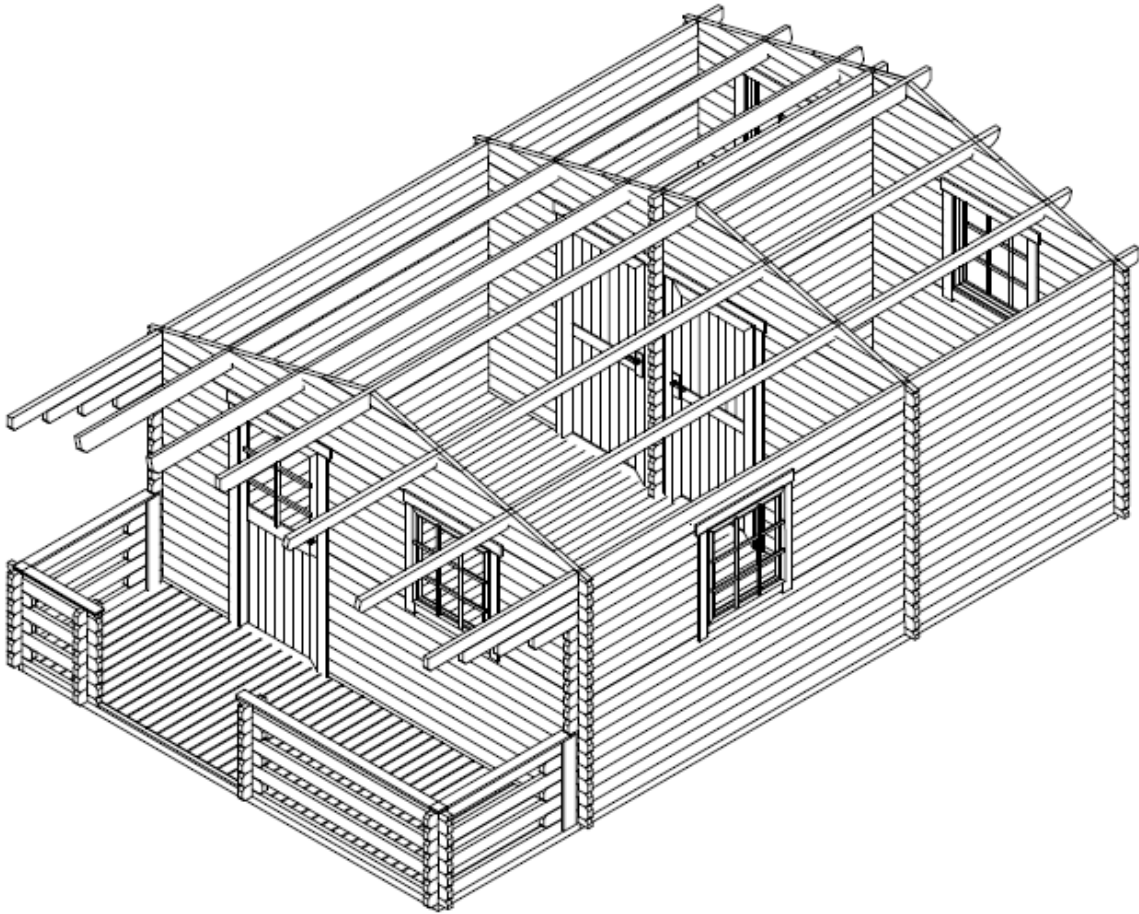

GROUNDPLAN - GRUNDPLAN - PLAN DE MASSE

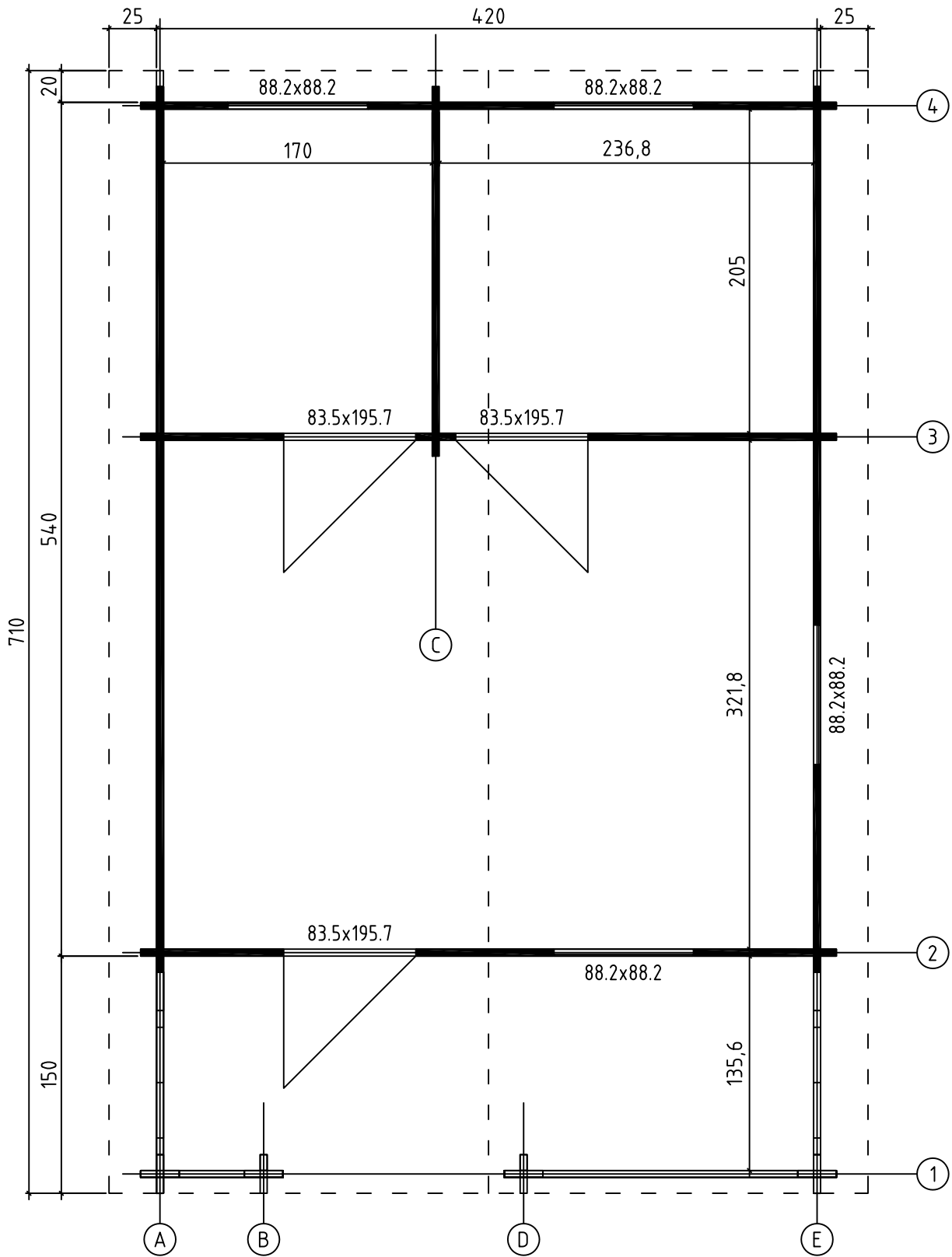

FOUNDATION - FUNDAMENT - FONDATION

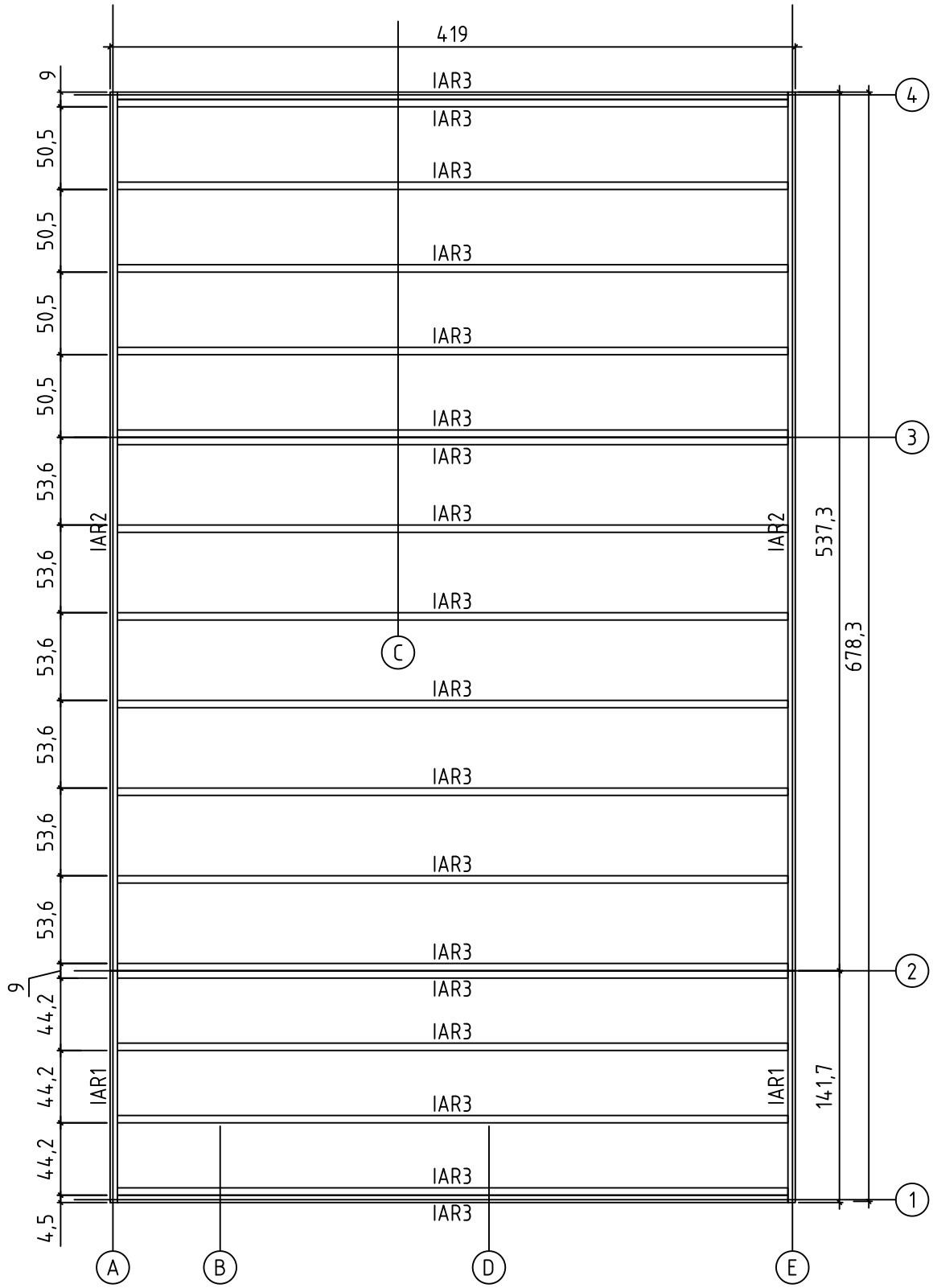

FLOOR BOARDS - FUSSBODENBRETTER - PLAN POSE PLANCHER

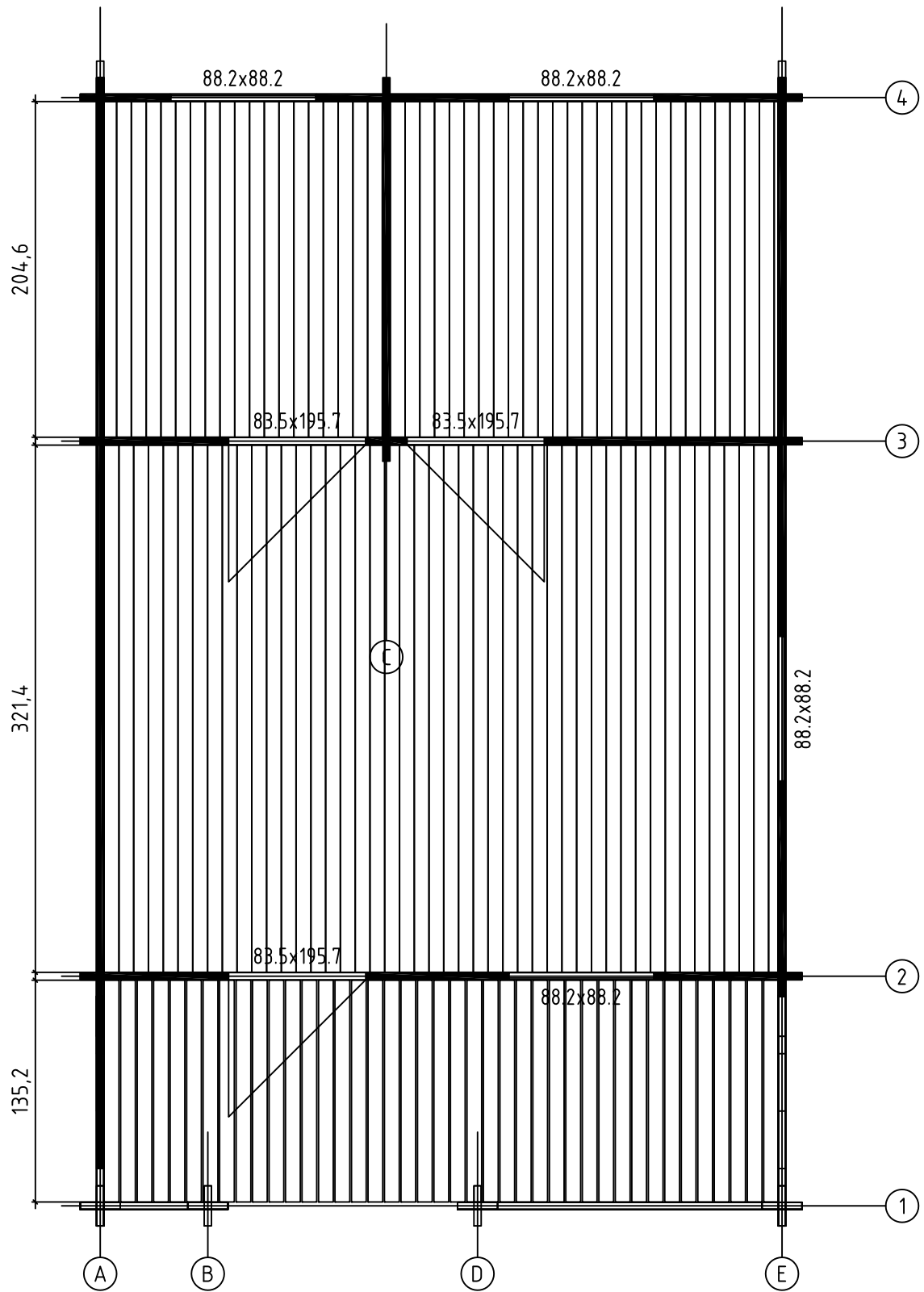

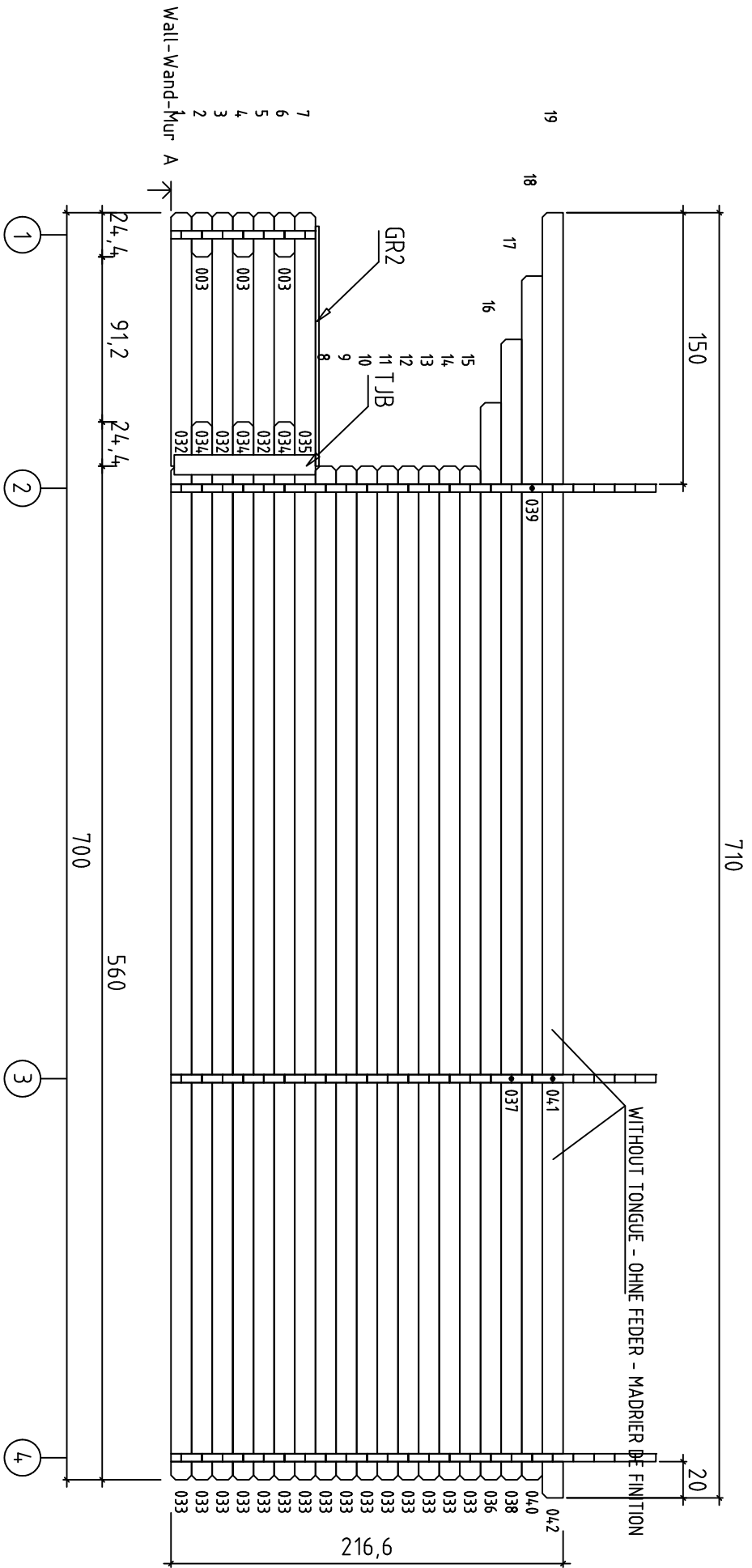



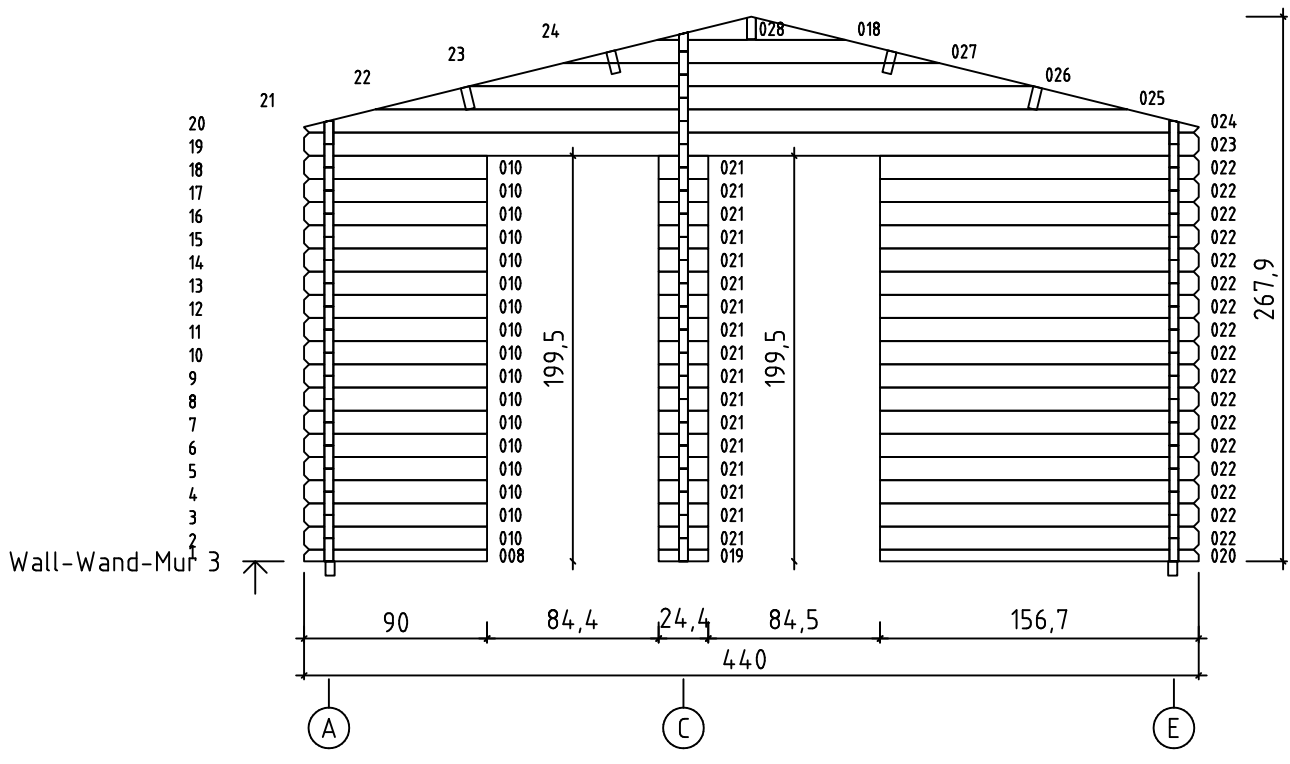
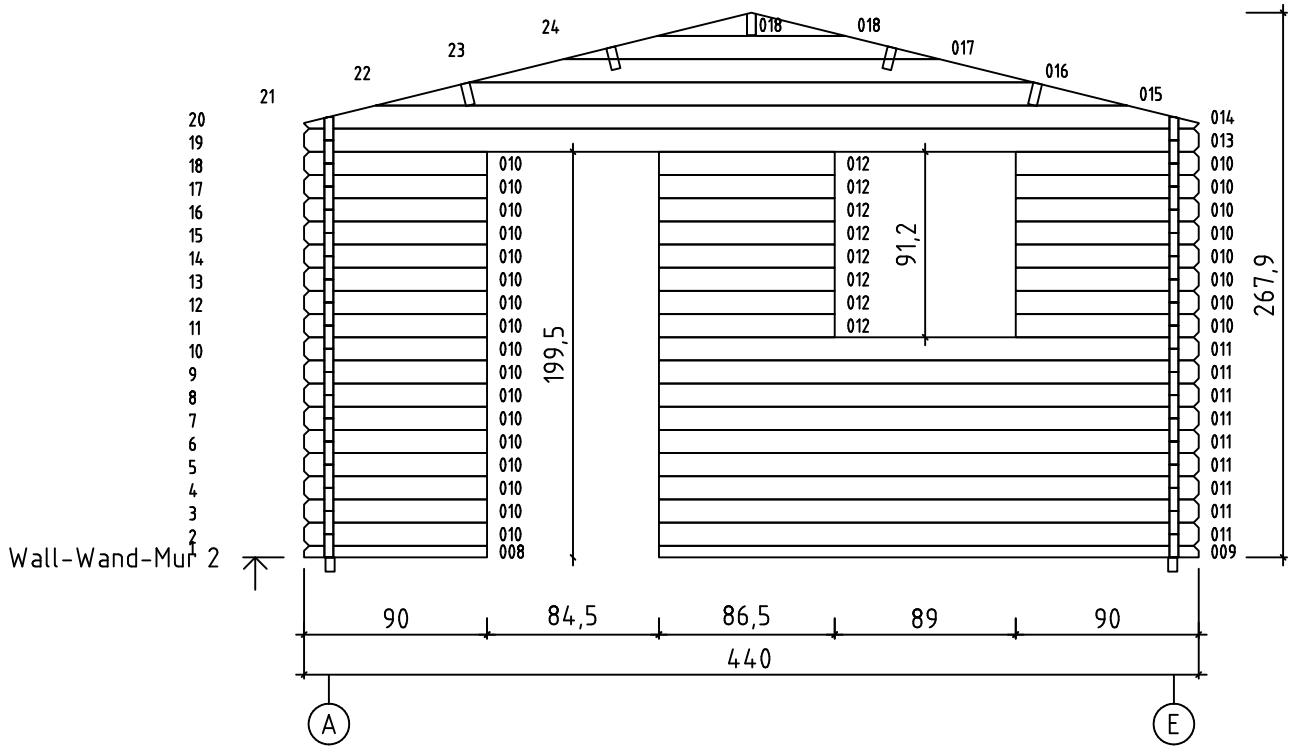

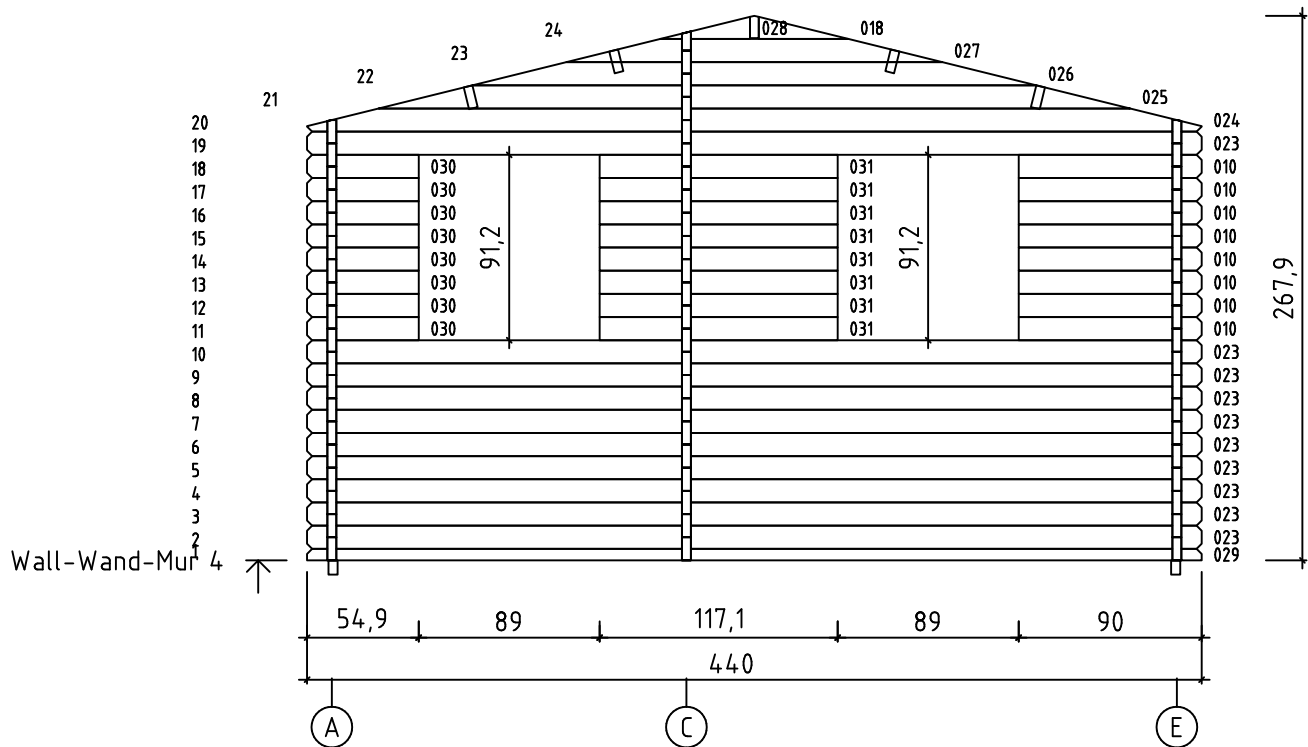

Wall-Wand-Mur 4

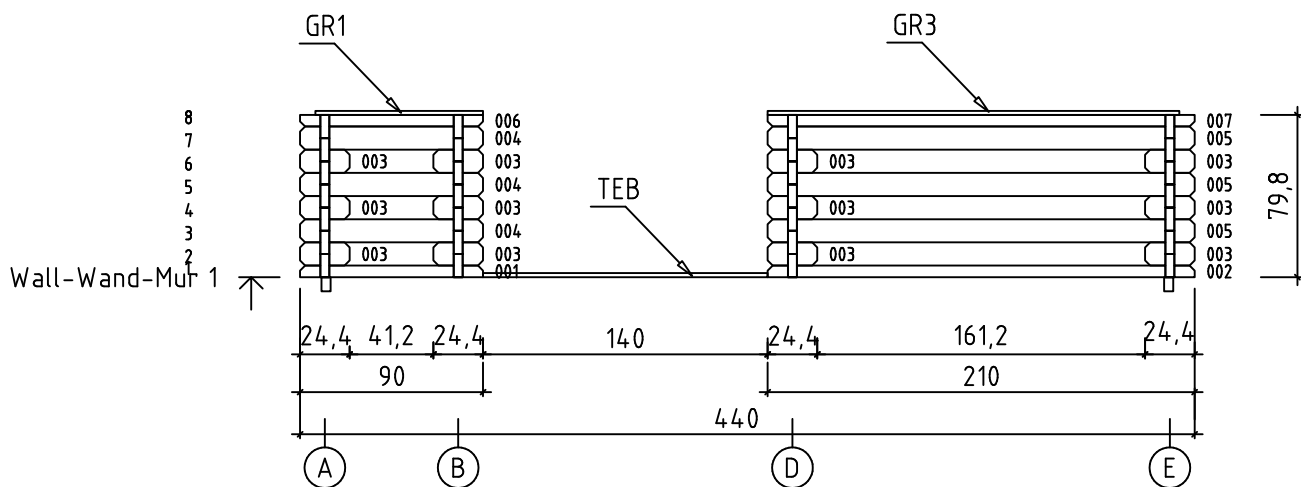
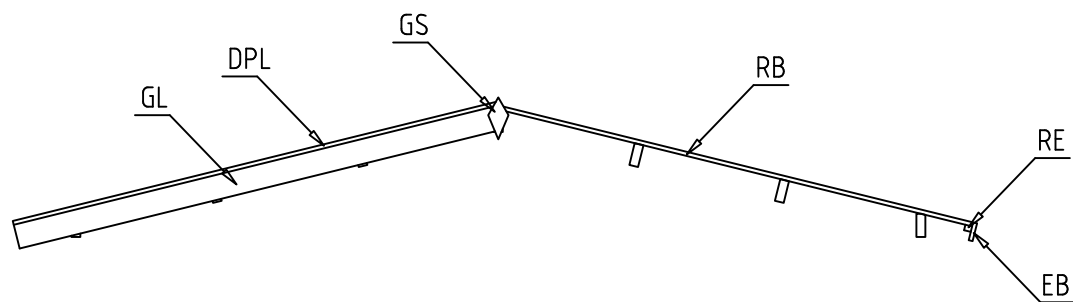

Wall-Wand-Mur 1





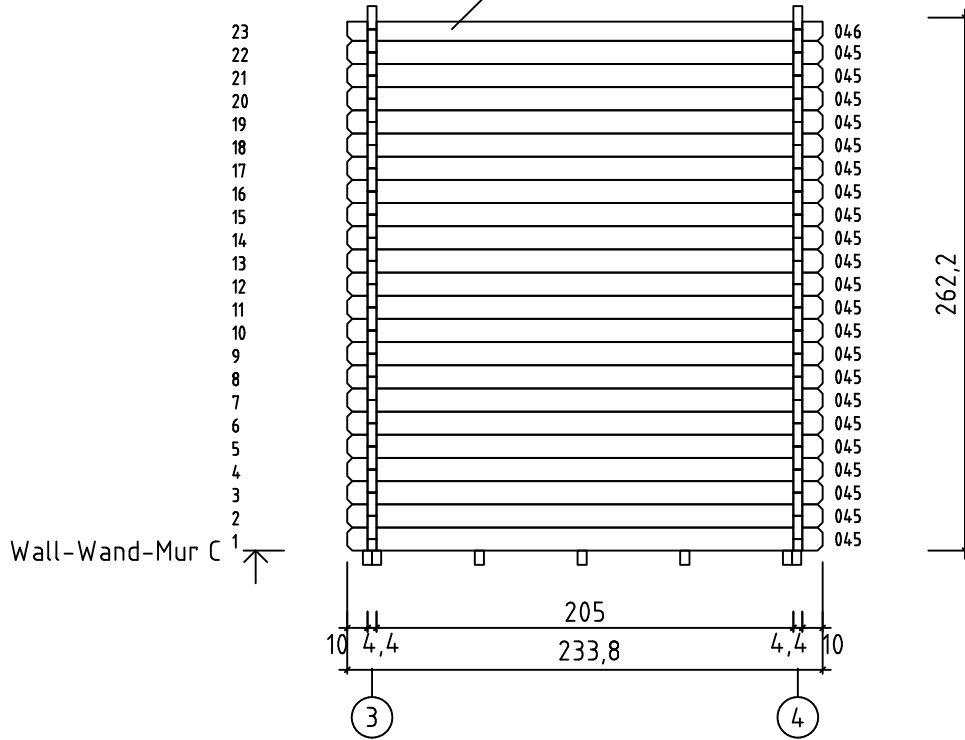



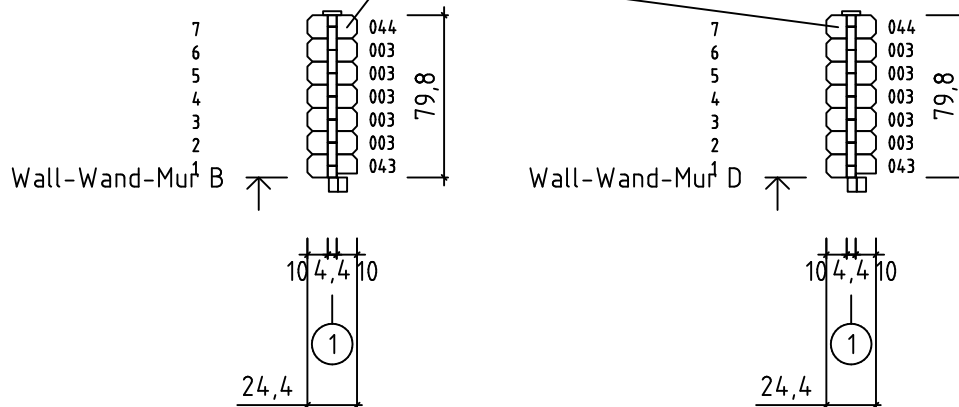

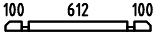
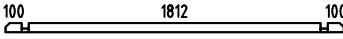

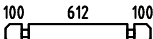
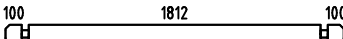
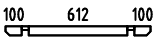
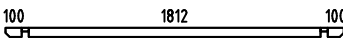
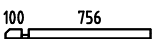
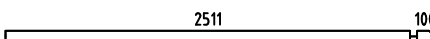
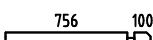
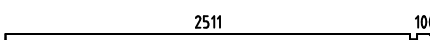
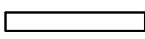
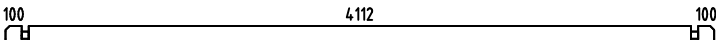

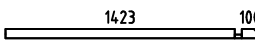

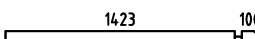
WITHOUT TONGUE - OHNE FEDER - MADRIER DE FINITION

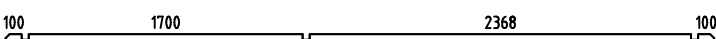

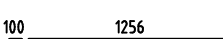

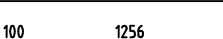

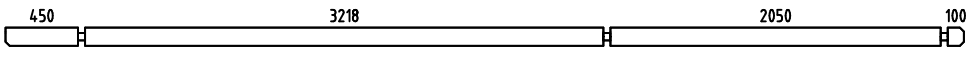
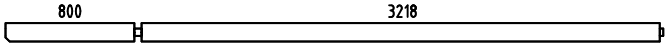
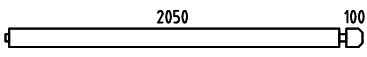
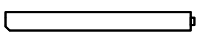
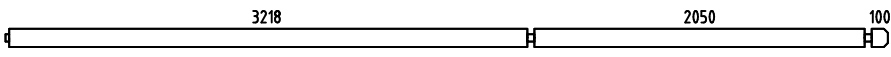
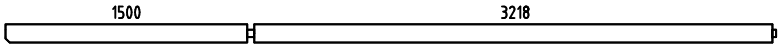
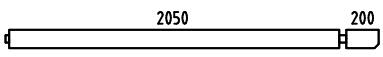

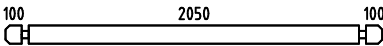
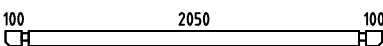
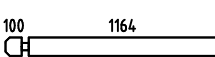
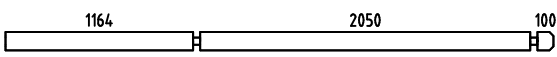
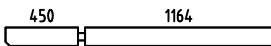
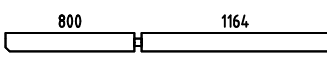
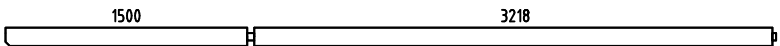
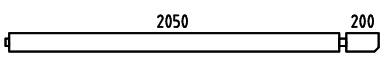
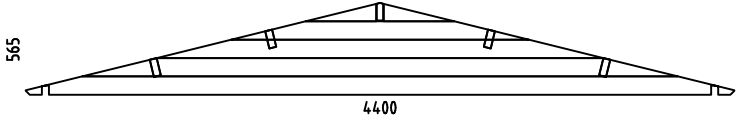
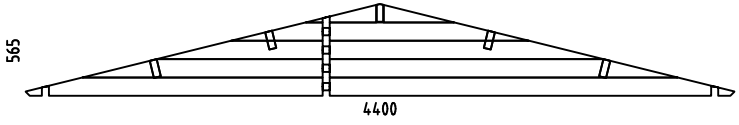
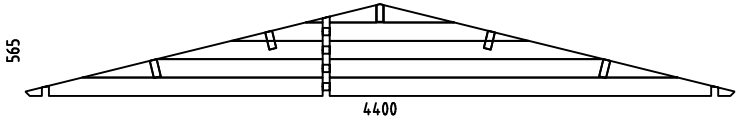

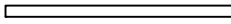

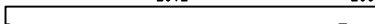

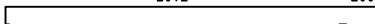



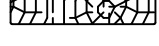

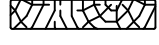

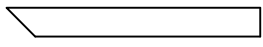
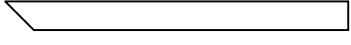
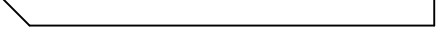
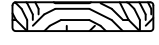
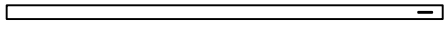
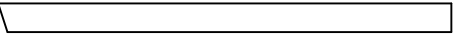

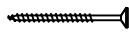
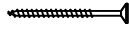
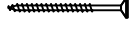
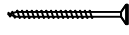

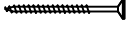





WITHOUT TONGUE - OHNE FEDER - MADRIER DE FINITION

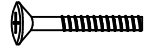

Pos	15.04.2011	ART.NR. 401302	10/14	Q.	P (mm)	L (mm)
001				1	44x57	900
002				1	44x57	2100
003				28	44x114	244
004				3	44x114	900
005				3	44x114	2100
006				1	44x57	900
007				1	44x57	2100
008				2	44x57	900
009				1	44x57	2655
010				50	44x114	900
011				9	44x114	2655
012				8	44x114	865
013				1	44x114	4400
019				1	44x57	244
020				1	44x57	1567
021				17	44x114	244
022				17	44x114	1567
023				11	44x114	4400
029				1	44x57	4400
030				8	44x114	549
031				8	44x114	1171
032				6	44x114	1400
033				24	44x114	5600
034				6	44x114	244
035				2	44x114	1400

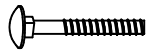
Pos	15.04.2011	ART.NR. 401302	11/14	Q.	P (mm)	L (mm)
036				1	44x114	5950
037				1	44x114	4084
038				1	44x114	2216
039				2	44x114	1172
040				2	44x114	5478
041				1	44x120	4784
042				1	44x120	2316
043				2	44x114	244
044				2	44x114	244
045				22	44x114	2338
046				1	44x94	2338
047				6	44x114	1308
048				8	44x114	3402
049				1	44x114	1658
050				1	44x114	2008
051				1	44x120	4784
052				1	44x120	2316
W2-1				1		
W3-1				1		
W4-1				1		
IAR2	FOUNDATION - FUNDAMENT - FONDATION			2	45x70	5373
IAR3	FOUNDATION - FUNDAMENT - FONDATION			18	45x70	4100

Pos	15.04.2011	ART.NR. 401302	12/14	Q.	P (mm)	L (mm)
IAR1	FOUNDATION - FUNDAMENT - FONDATION 			2	45x70	1417
PR1	ROOF BEAM - DACHBALKEN - PANNE DE TOIT 1500 3240 			1	44x140	4784
PR2	ROOF BEAM - DACHBALKEN - PANNE DE TOIT 2072 200 			1	44x140	2316
APR1	ROOF BEAM - DACHBALKEN - PANNE DE TOIT 1500 3240 			4	44x140	4784
APR2	ROOF BEAM - DACHBALKEN - PANNE DE TOIT 2072 200 			4	44x140	2316
	FLOOR BOARDS - FUSSBODENBRETTER - LAME DE PLANCHER 			46	90x18	3214
	FLOOR BOARDS - FUSSBODENBRETTER - LAME DE PLANCHER 			46	90x18	2046
RB	ROOF BOARDS - DACHBRETTER - VOLIGES 			158	90x18	2400
	TERRACE BOARDS - TERRASSENBRETTER - PLANCHER DE TERRASSE 			41	90x19	1352
	FLOOR FILLET-FUSSBODENLEISTE - CORNIERE DE FINITION DU PLANCHER 				18x18	30.95
DPL	ROOFING FELT FILLET - DACHPAPPENLEISTE - BAGUETTE DE FIXATION DU FEUTRE BITUMEUX 			4	18x58	2450
EB	EAVES BOARD - TRAUFBRETT - BANDEAU DE TOIT 			4	18x90	3550
RE	ROOF EDGE REINFORCEMENT - DACHRANDVERSTÄRKUNG - CORNIERE DE RENFORT DE BORD DE TOIT 			4	28x34	3550
TEB	TERRACE BOARD - TERRASSENBRETT - LAME DE SEUIL D'ENTREE DE TERRASSE 			1	19x44	1400
GR1	GUARD-RAIL FOR TERRACE - TERRASSENSELÄNDER MAIN COURANTE DE TERRASSE 			1	18x90	825
GR2	GUARD-RAIL FOR TERRACE - TERRASSENSELÄNDER MAIN COURANTE DE TERRASSE 			2	18x90	1325
GR3	GUARD-RAIL FOR TERRACE - TERRASSENSELÄNDER MAIN COURANTE DE TERRASSE 			1	18x90	2025
TJB	TERRACE JOIT BOARDS - VERBINDUNGSBRETT - PROFIL DE JONCTION POUR FIXER LA TERRASSE AU MUR 			4	18x120	780
	STORM PROTECTION - STURMLEISTE LATTE ANTI-TEMPETE 			4	22x45	2100
GL	GABLE MOULDING - GIEBELLEISTE PLANCHE DE RIVE 			4	18x120	2450
	WINDOW HANDLE FITTINGS-FENSTERGRIFF - POIGNÉE D'OUVERTURE DE FENETRE 			4		
	SCREW FOR GABLE SEGMENT - SCHRAUBEN FÜR DECKBLATT - VIS POUR FIXATION LOSANGE DE FINITION 			4	3.5x35	
	SCREW FOR TERRACE JOINT BOARDS - SCHRAUBEN FÜR VERBINDUNGSBRETT - VIS DE FIXATION PROFIL DE JONCTION TERRASSE 			28	3.5x50	
	SCREW FOR EAVES BOARDS - SCHRAUBEN FÜR TRAUFBRETTER - VIS DE FIXATION POUR BANDEAU DE TOIT 			32	4x40	
	SCREW FOR ROOF EDGE REINFORCEMENT - SCHRAUBEN FÜR DACHRANDVERSTÄRKUNG - VIS POUR RENFORT DE BORD DE TOIT 			32	4x40	

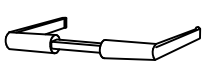
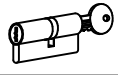
Pos	15.04.2011	ART.NR. 401302	13/14	Q.	P (mm)	L (mm)
	SCREWS FOR TERRACE BOARD - SCHRAUBEN FÜR TERRASSENBRETT - VIS DE FIXATION DE LAME DE SEUIL D'ENTREE DE TERRASSE		5	4x40		
	SCREW FOR TERRACE REAR BOARDS - SCHRAUBEN FÜR TERRASSENRAND - VIS DE FIXATION POUR MAIN COURANTE DE TERRASSE		18	4x40		
	SCREW FOR GABLE - SCHRAUBEN FÜR GIEBEL - VIS POUR FIXATION DES PIGNONS		20	5x120		
	SCREW FOR ROOF BEAMS - SCHRAUBEN FÜR DACHBALKEN - VIS POUR PANNE DE TOIT		21	5x120		
	SCREW FOR 1. WALL BEAM - SCHRAUBE FÜR 1. BOHLENREIHE - VIS DE FIXATION DES FONDATIONS		17	5x90		
	SCREW FOR FUNDAMENT - SCHRAUBEN ZUR BEFESTIGUNG FUNDAMENT - VIS POUR FONDATION		44	5x90		
	SCREW FOR BEAM HOLDER - SCHRAUBEN FÜR BALKENHALTER - VIS DE FIXATION SUPPORT "U" GALVANISÉ		120	4x40		
	ZN NAIL FOR TERRACE - ZN NÄGEL FÜR TERRASSENBRETT - POINTE POUR PLANCHER DE TERRASSE		336	2x50		
	ZN NAIL FOR FLOOR FILLET - ZN NÄGEL FÜR FUSSBODENLEISTE - POINTE POUR CORNIERE DE FINITION DU PLANCHER		62	1.4x40		
	HAMMER BLOCK - SCHLAGHOLZ - CALLE DE FRAPPE		1			
	ZN NAIL FOR ROOFING FELT FILLET - ZN NÄGEL FÜR DACHPAPPEN-LEISTE - POINTE POUR BAGUETTE FIXATION FEUTRE BITUMEUX		24	2x40		
	BOLT FOR WINDOW HANDLE FITTINGS - BOLZEN FÜR FENSTERGRIFF BESCHLAG - BOULON POUR POIGNÉE D'OUVERTURE DE FENETRE		8			
	SCREW FOR GABLE MOULDING - SCHRAUBEN FÜR GIEBELLEISTE - VIS DE FIXATION POUR PLANCHE DE RIVE		32	3.5x50		
GS	GABLE SEGMENT-DECKBLATT - LOSANGE DE FINITION		2			
	BEAM HOLDER - BALKENHALTER - SUPPORT EN "U" GALVANISÉ		10			
	NUT FOR STORM PROTECTION - SCHRAUBENMUTTER FÜR STURMLEISTE - ÉCROU POUR LAME ANTI-TEMPETE		8			
	BOLT FOR STORM PROTECTION - BOLZEN FÜR STURMLEISTE - VIS POUR LAME ANTI-TEMPETE		8			
	WASHER FOR STORM PROTECTION - DICHTSCHEIBE FÜR STURMLEISTE - RONDELLE POUR LAME ANTI-TEMPETE		8			
	ZN NAIL FOR ROOF - ZN NÄGEL FÜR DACHBRETT - POINTE POUR TOIT		658	2x50		
	ZN NAIL FOR FLOOR - ZN NÄGEL FÜR FUSSBODENBRETT - CLOUS POUR PLANCHER		569	2x50		
	SET OF DOOR LOCK COVERS - SCHLOSSBLENDEN - SET DE GARNITURES DE SERRURE DE PORTE		3			
	DOOR HANDLE FITTINGS-TÜRGRIF - SET DE GARNITURES DE SERRURE DE PORTE		3			
	CYLINDER -ZYLINDERSCHLOSS - CYLINDRE DE SERRURE		3			

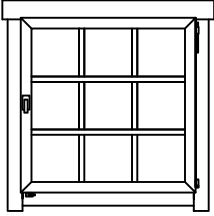
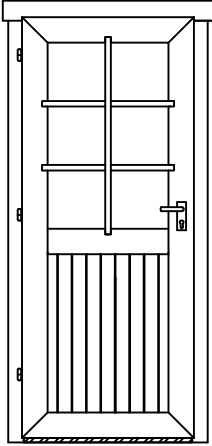
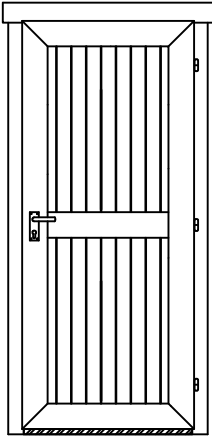
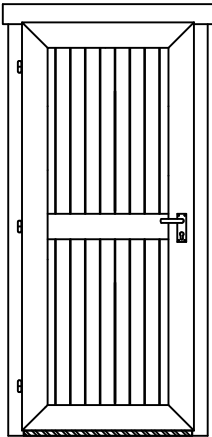
Pos	15.04.2011	ART.NR. 4.01302	14/14	Q.	P (mm)	L (mm)
	WINDOW-FENSTER-FENETRE 882x882		AK.1.109.PSP.b	4		
	DOOR-TÜR-PORTE 835x1957		UK.2.056.PVV.MM	1		
	DOOR-TÜR-PORTE 835x1957		UL.2.100.IVP.MM	1		
	DOOR-TÜR-PORTE 835x1957		UL.2.100.IVV.MM	1		