

BARBADOS 4

ART.NR. 446611

1/9

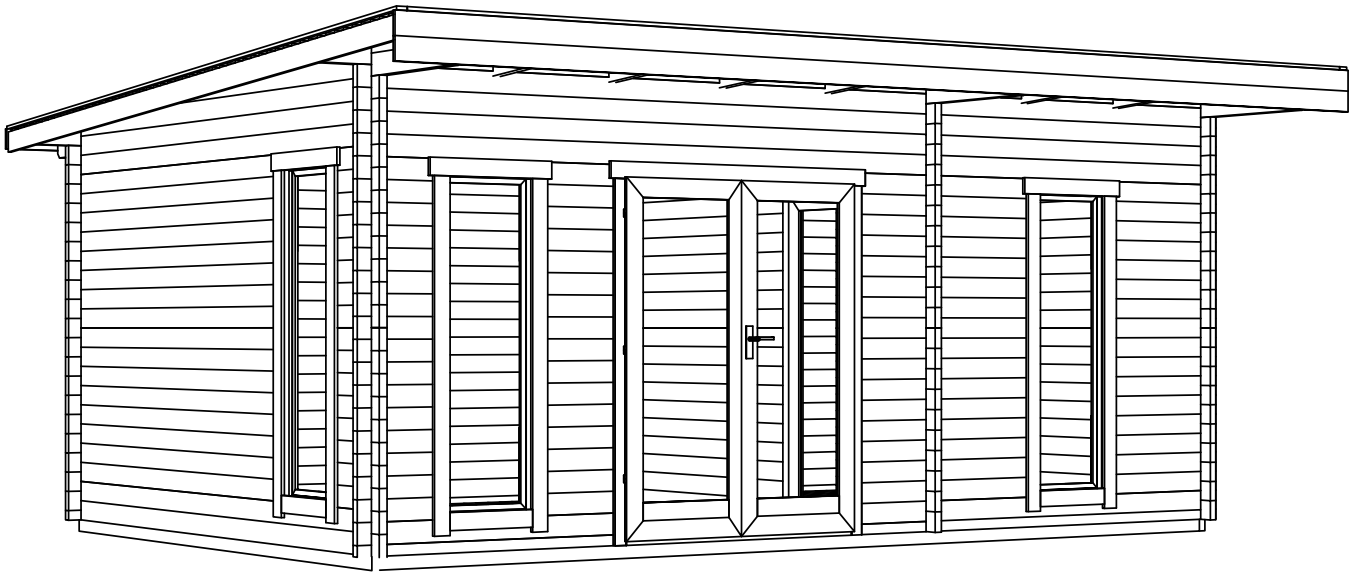

GROUNDPLAN - GRUNDPLAN - PLAN DE MASSE

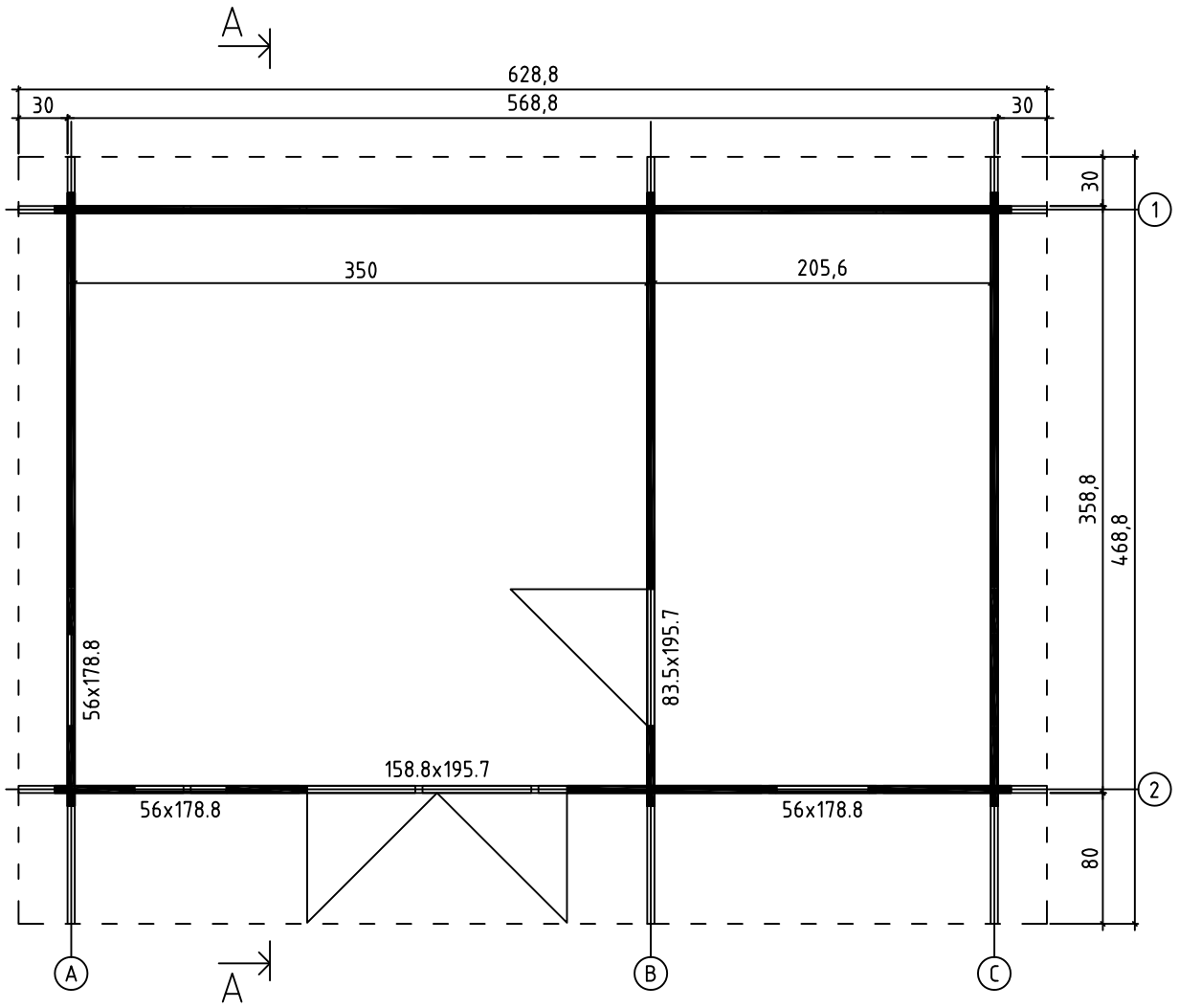

FOUNDATION - FUNDAMENT - FONDATION

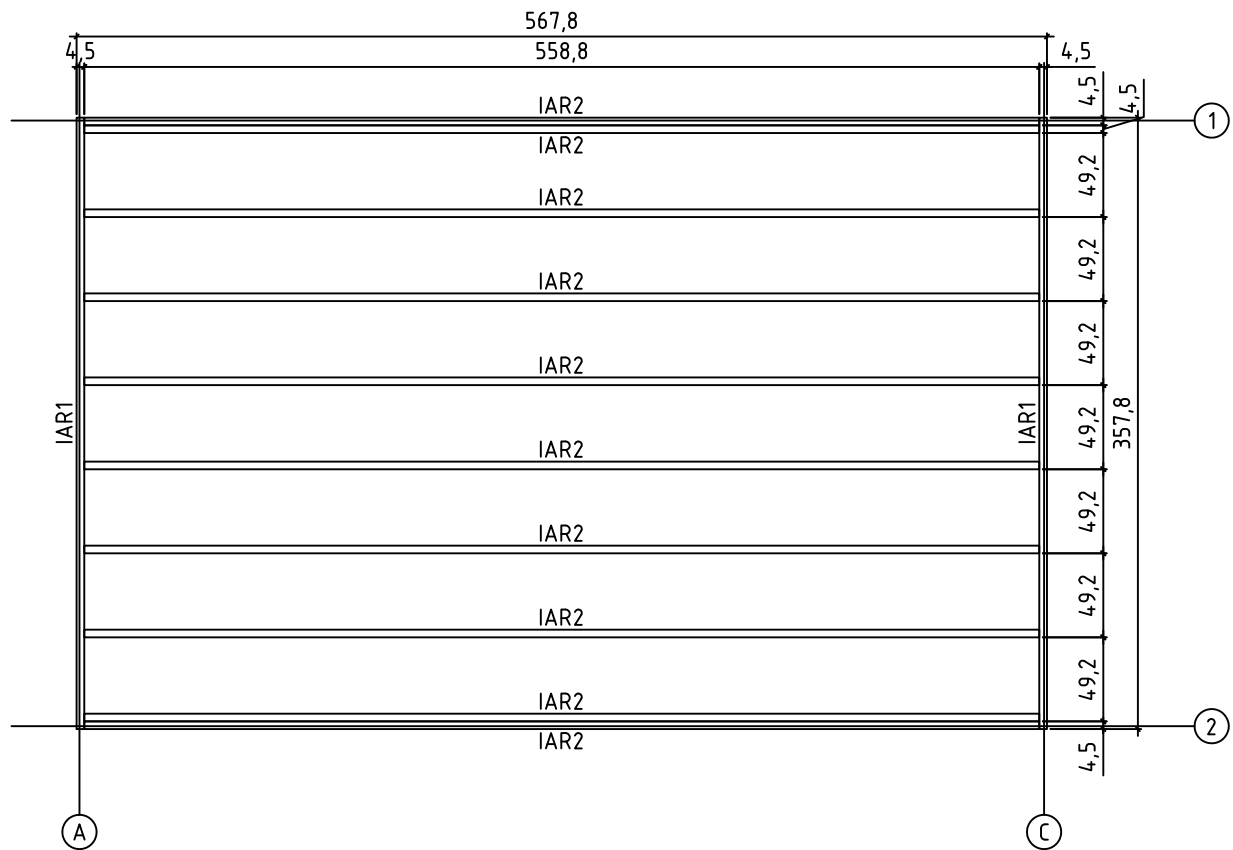



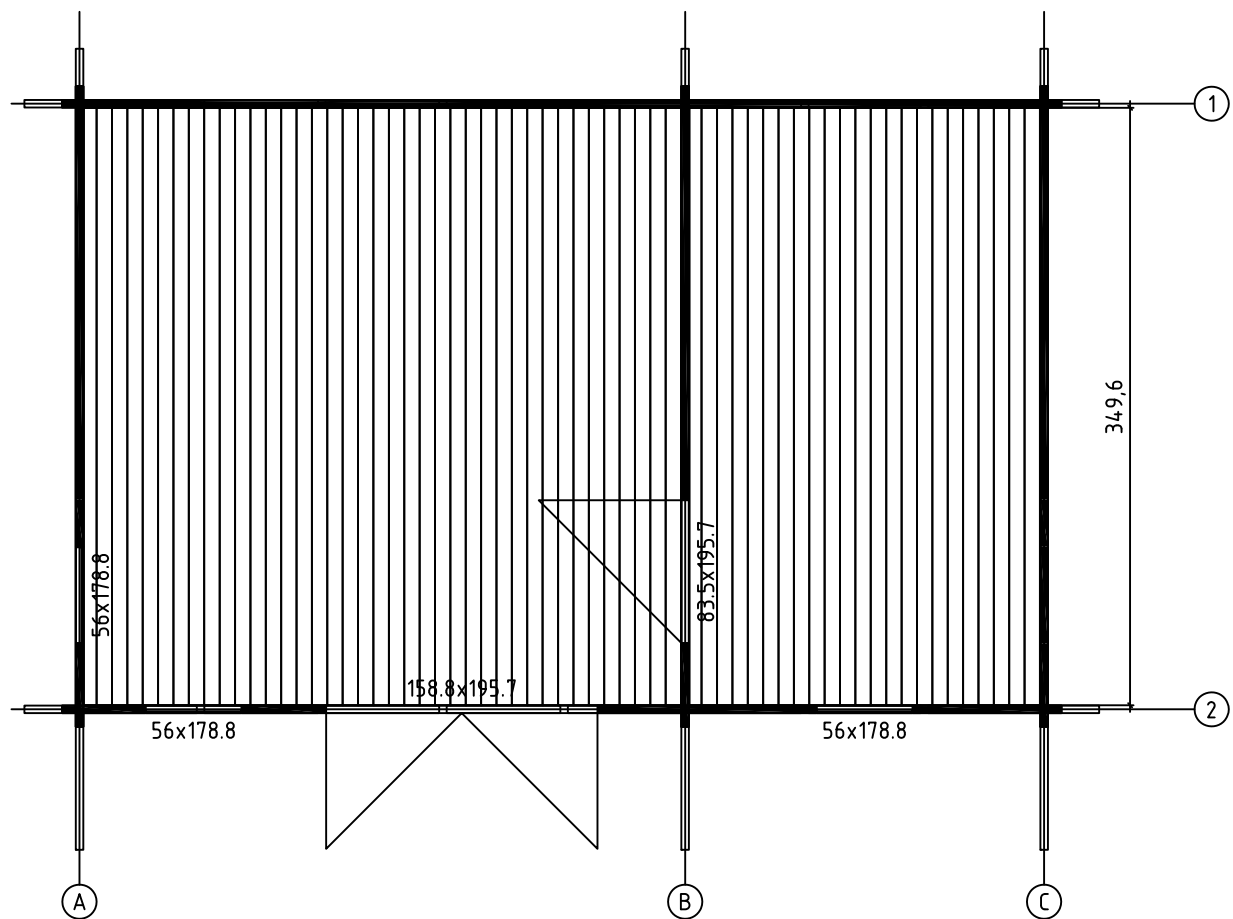

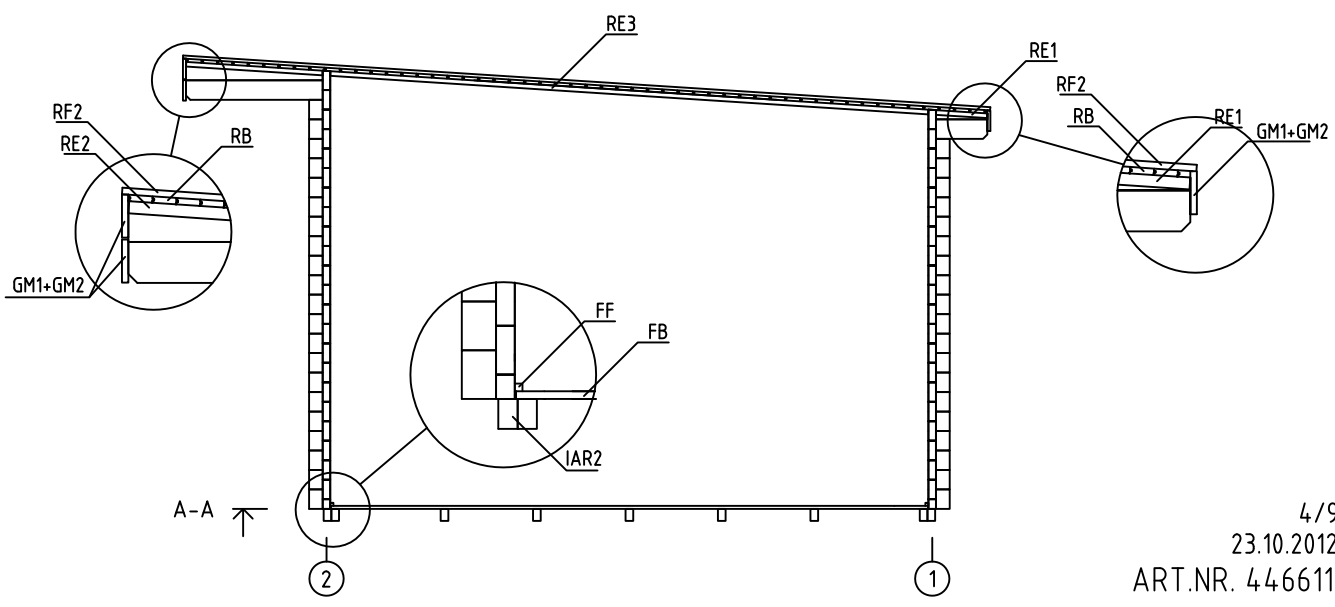
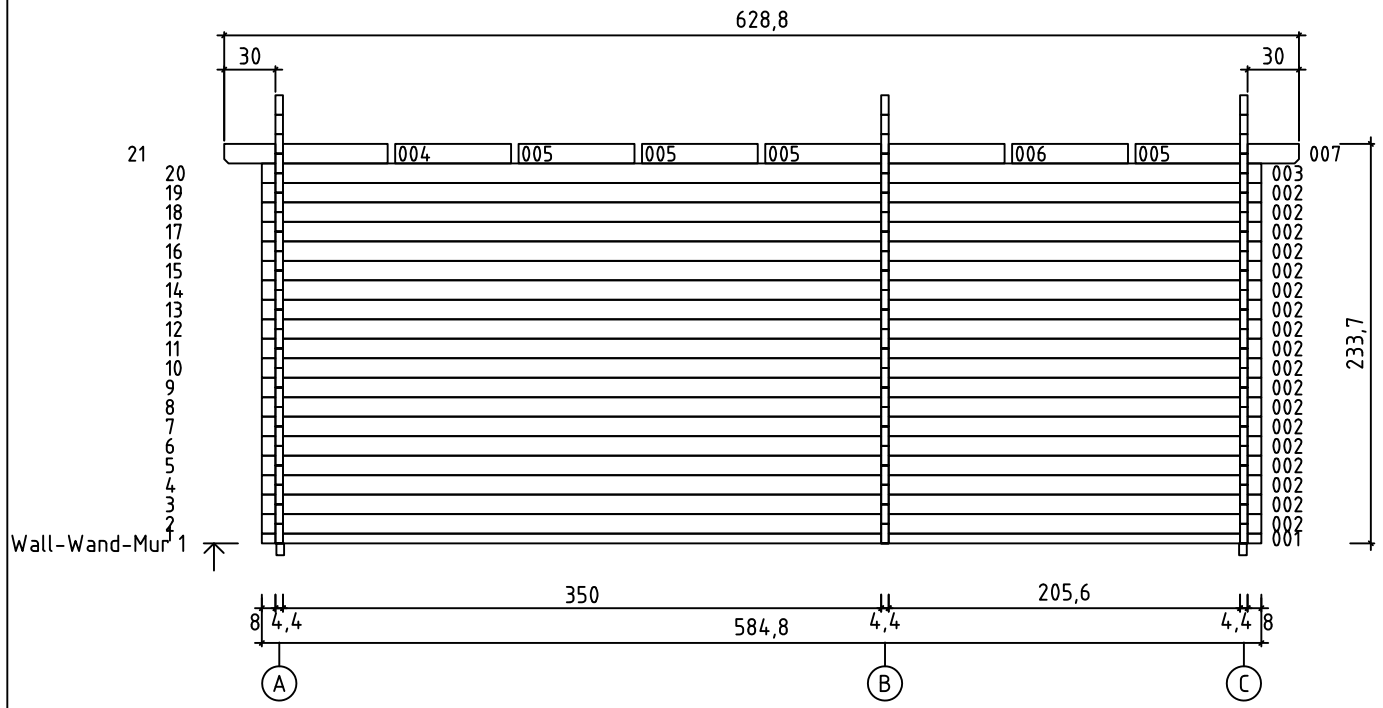
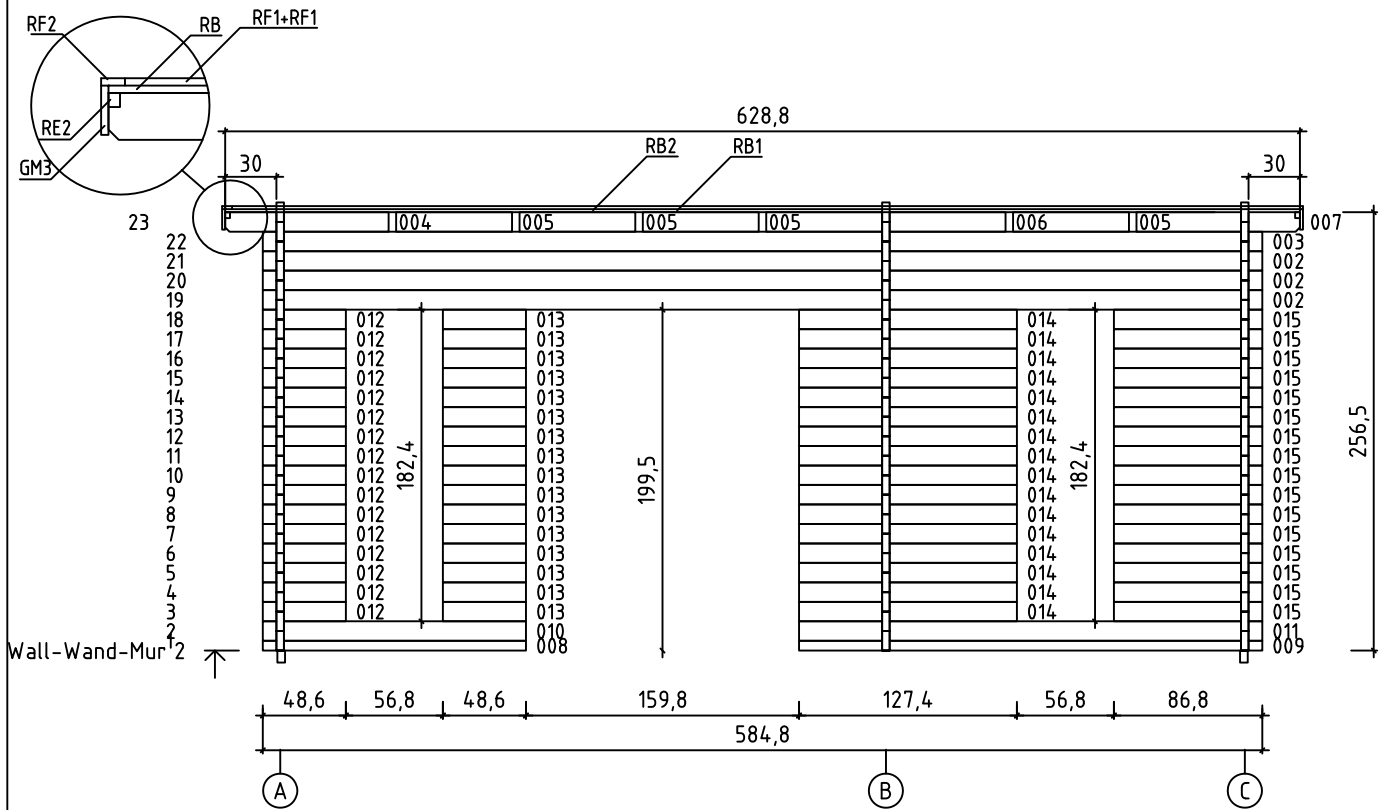

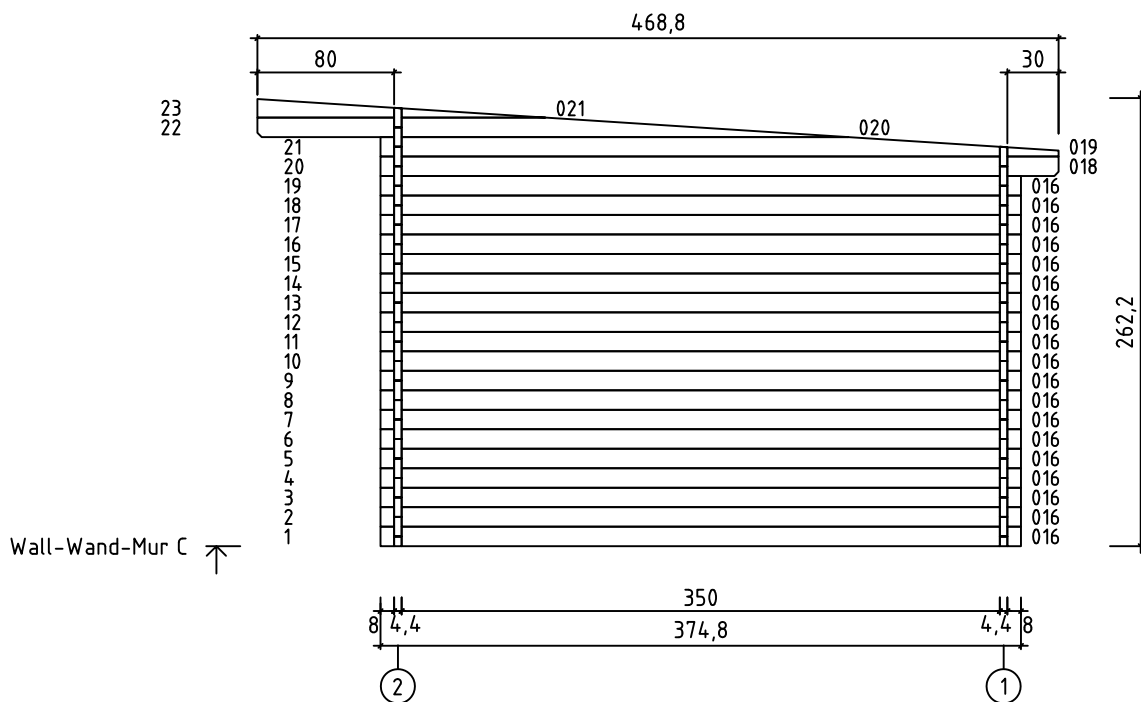
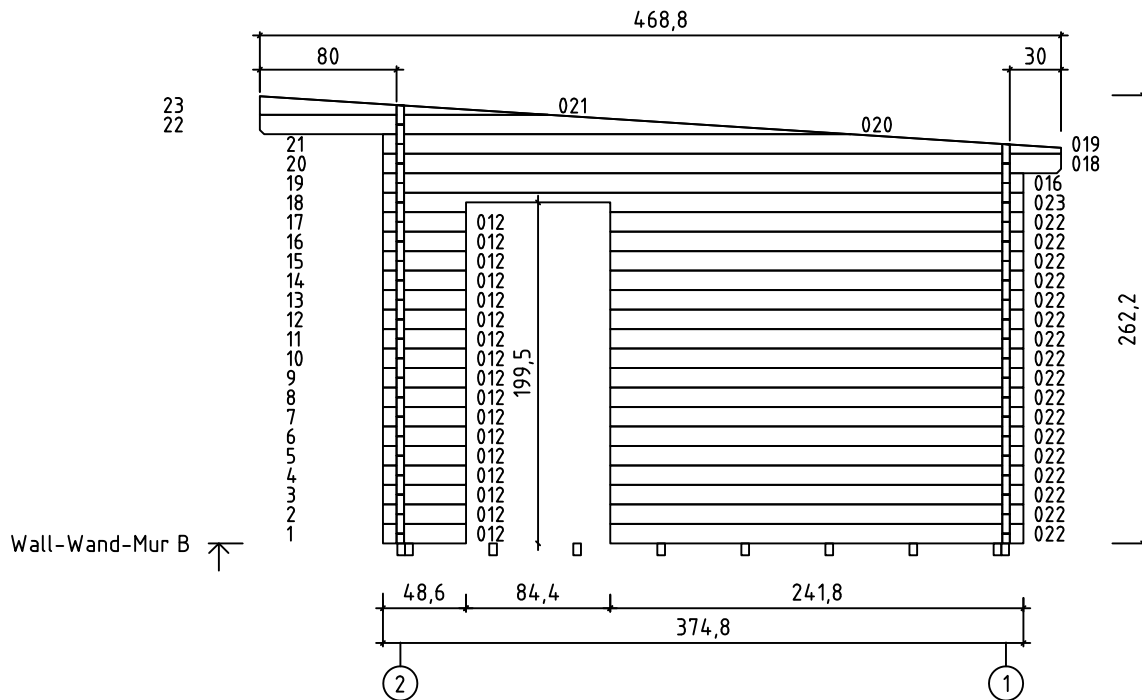
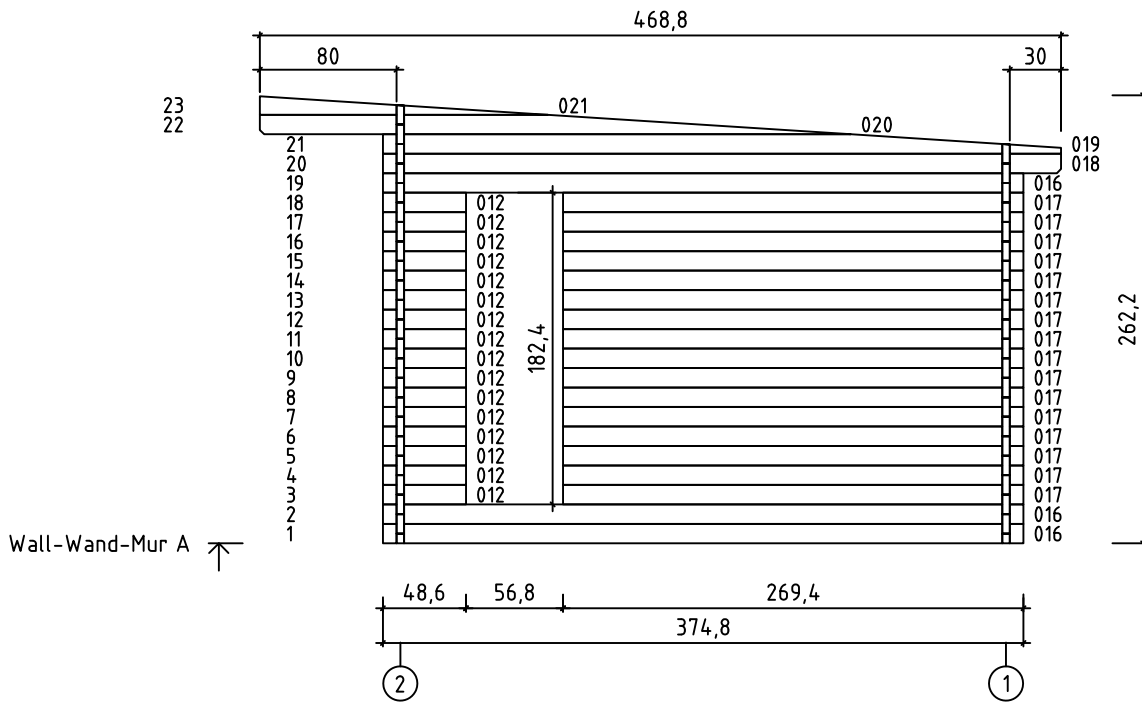



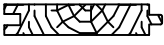



FLOOR BOARDS - FUSSBODENBRETTER - PLAN POSE PLANCHER



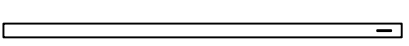
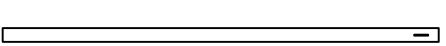
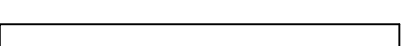
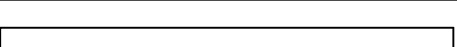
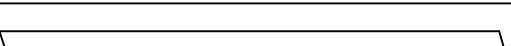





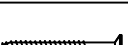
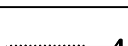
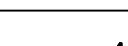
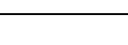

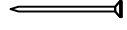

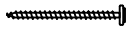
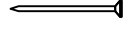
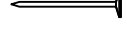

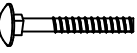

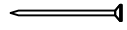
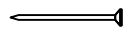
Pos	23.10.2012	ART.NR. 446611	6/9	Q.	P (mm)	L (mm)
001				1	44x57	5848
002				21	44x114	5848
003				2	44x114	5848
004				2	44x114	956
005				8	44x114	678
006				2	44x114	1400
007				2	44x114	956
008				1	44x57	1540
009				1	44x57	2710
010				1	44x114	1540
011				1	44x114	2710
012				49	44x114	486
013				16	44x114	486
014				16	44x114	1274
015				16	44x114	868
016				23	44x114	3748
017				16	44x114	2694
018				3	44x114	3968
022				17	44x114	2418
023				1	44x114	3748
WA-1				1		
WB-1				1		
WC-1				1		
IAR2	FOUNDATION - FUNDAMENT - FONDATION					
IAR1	FOUNDATION - FUNDAMENT - FONDATION					

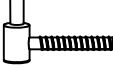
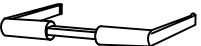
Pos	23.10.2012	ART.NR. 446611	7/9	Q.	P (mm)	L (mm)
SR1	RAFTER - DACHSPARREN - CHEVRON			6	44x140	4706
FB	FLOOR BOARDS - FUSSBODENBRETTER - LAME DE PLANCHER		62	90x18	3496	
RB1	ROOF BOARDS - DACHBRETTER - VOLIGES		53	90x18	3866	
RB2	ROOF BOARDS - DACHBRETTER - VOLIGES		53	90x18	2422	
FF	FLOOR FILLET-FUSSBODENLEISTE - CORNIERE DE FINITION DU PLANCHER			18x18	25.08	
RF1	ROOFING FELT FILLET - DACHPAPPENLEISTE - BAGUETTE DE FIXATION DU FEUTRE BITUMEUX		2	18x58	3104	
RF2	ROOFING FELT FILLET - DACHPAPPENLEISTE - BAGUETTE DE FIXATION DU FEUTRE BITUMEUX		2	18x58	4734	
	ROOFING FELT - DACHPAPPE - FEUTRE BITUMEUX		6		6390	
RE1	ROOF EDGE REINFORCEMENT - DACHRANDVERSTÄRKUNG - CORNIERE DE RENFORT DE BORD DE TOIT		2	28x34	297	
RE2	ROOF EDGE REINFORCEMENT - DACHRANDVERSTÄRKUNG - CORNIERE DE RENFORT DE BORD DE TOIT		2	28x34	800	
RE3	ROOF EDGE REINFORCEMENT - DACHRANDVERSTÄRKUNG - CORNIERE DE RENFORT DE BORD DE TOIT		2	28x34	3500	
	STORM PROTECTION - STURMLEISTE LATTE ANTI-TEMPETE		2	22x45	2250	
	STORM PROTECTION - STURMLEISTE LATTE ANTI-TEMPETE		2	22x45	2480	
GM1	GABLE MOULDING - GIEBELLEISTE PLANCHE DE RIVE		3	18x120	2450	
GM2	GABLE MOULDING - GIEBELLEISTE PLANCHE DE RIVE		3	18x120	3894	
GM3	GABLE MOULDING - GIEBELLEISTE PLANCHE DE RIVE		2	18x120	4705	
FS	WINDOW HANDLE FITTINGS-FENSTERGRIFF - POIGNÉE D'OUVERTURE DE FENETRE		6			
HS16	SCREW FOR GABLE MOULDING - SCHRAUBEN FÜR GIEBELLEISTE - VIS DE FIXATION POUR PLANCHE DE RIVE		86	3.5x50		
HS3	SCREW FOR DOOR FILLET - SCHRAUBE ZUR BEFESTIGUNG TÜRLEISTE - VIS D'ASSEMBLAGE DU CADRE DE PORTE		5	3x30		
HS26	SCREW FOR ROOF EDGE REINFORCEMENT - SCHRAUBEN FÜR DACHRANDVERSTÄRKUNG - VIS POUR RENFORT DE BORD DE TOIT		26	4x40		
HS43	SCREW FOR ROOF BEAMS - SCHRAUBEN FÜR DACHBALKEN - VIS POUR PANNE DE TOIT		18	5x120		
HS42	SCREW FOR GABLE - SCHRAUBEN FÜR GIEBEL - VIS POUR FIXATION DES PIGNONS		9	5x120		
HS40	SCREW FOR 1. WALL BEAM - SCHRAUBE FÜR 1. BOHLENREIHE - VIS DE FIXATION DES FONDATIONS		8	5x90		
HS39	SCREW FOR FUNDAMENT - SCHRAUBEN ZUR BEFISTIGUNG FUNDAMENT - VIS POUR FONDATION		28	5x90		
HS41	SCREW FOR DOOR JAMB - SCHRAUBE FÜR TÜRRAHMEN - VIS DE FIXATION POUR MONTANT DE PORTE		4	5x90		

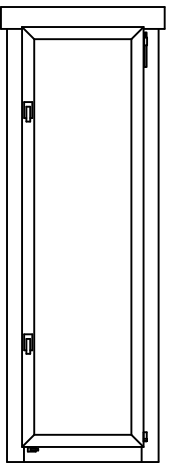
Pos	23.10.2012	ART.NR. 446611	8/9	Q.	P (mm)	L (mm)
HS48	SCREW FOR Pos. 004-008 - SCHRAUBEN FÜR für Pos. 004-008 - VIS POUR FIXATION DERNIÈRE RANGÉE MADRIERS (MURS AVANT ET ARRIÈRE)			16	6x180	
NFF	ZN NAIL FOR FLOOR FILLET - ZN NÄGEL FÜR FUSSBODENLEISTE - POINTE POUR CORNIÈRE DE FINITION DU PLANCHER			58	1.4x40	
SH44	HAMMER BLOCK - SCHLAGHOLZ - CALLE DE FRAPPE			1		
	SCREW FOR DOORSTEP - SCHRAUBEN FÜR TÜRSWELLE - VIS DE FIXATION DU SEUIL DE PORTE			3	4.5x65	
NFD	ZN NAIL FOR ROOFING FELT FILLET - ZN NÄGEL FÜR DACHPAPPEN LEISTE - POINTE POUR BAGUETTE FIXATION FEUTRE BITUMEUX			38	2x40	
NF	ROOFING NAILS FOR ROOFING FELT - NÄGEL FÜR DACHPAPPE - POINTE DE FIXATION POUR FEUTRE BITUMEUX			301	2x17	
TS	BOLT FOR WINDOW HANDLE FITTINGS - BOLZEN FÜR FENSTERGRIFF BESCHLAG - BOULON POUR POIGNÉE D'OUVERTURE DE FENETRE			12		
SFS	NUT FOR STORM PROTECTION - SCHRAUBENMUTTER FÜR STURMLEISTE - ÉCROU POUR LAME ANTI-TEMPETE			8		
BFS	BOLT FOR STORM PROTECTION - BOLZEN FÜR STURMLEISTE - VIS POUR LAME ANTI-TEMPETE			8		
DFS	WASHER FOR STORM PROTECTION - DICHTSCHEIBE FÜR STURMLEISTE - RONDELLE POUR LAME ANTI-TEMPETE			8		
	ZN NAIL FOR ROOF - ZN NÄGEL FÜR DACHBRETTER - POINTE POUR TOIT			540	2x50	
	ZN NAIL FOR FLOOR - ZN NÄGEL FÜR FUSSBODENBRETTER - CLOUS POUR PLANCHER			512	2x50	
TS4	SET OF DOOR LOCK COVERS - SCHLOSSBLENDEN - SET DE GARNITURES DE SERRURE DE PORTE			2		
TS2	MALE BOLT HINGE FOR DOOR - TÜRRIEGEL - PARTIE MALE DE CHARNIERE DE PORTE			6		
	DOOR HANDLE FITTINGS-TÜRGRIFF - SET DE GARNITURES DE SERRURE DE PORTE			2		
	CYLINDER LOCK - ZYLINDERSCHLOSS - CYLINDRE DE SERRURE			2		
	WINDOW-FENSTER-FENETRE 560x1788		AK.1.100.PSP	3		

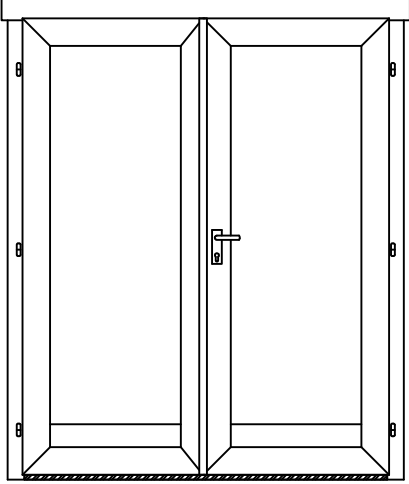
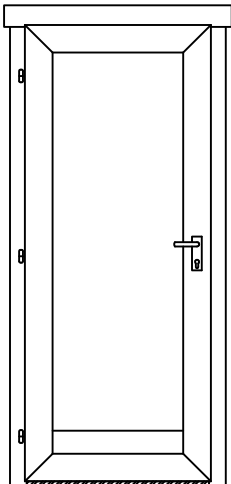
Pos	23.10.2012	ART.NR. 446611	9/9	Q.	P (mm)	L (mm)
	DOOR-TÜR-PORTE 1588x1957		TUK.1.100.PVP.MM	1		
	DOOR-TÜR-PORTE 835x1957		UK.1.100.PVV.MM	1		