

BARBADOS 3
ART.NR. 443711
1/7

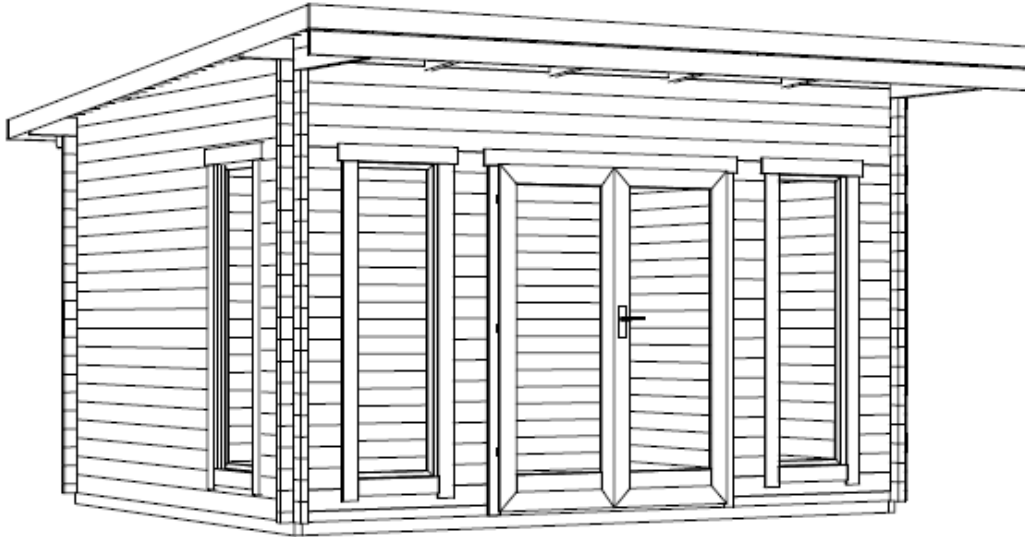

GROUNDPLAN - GRUNDPLAN - PLAN DE MASSE

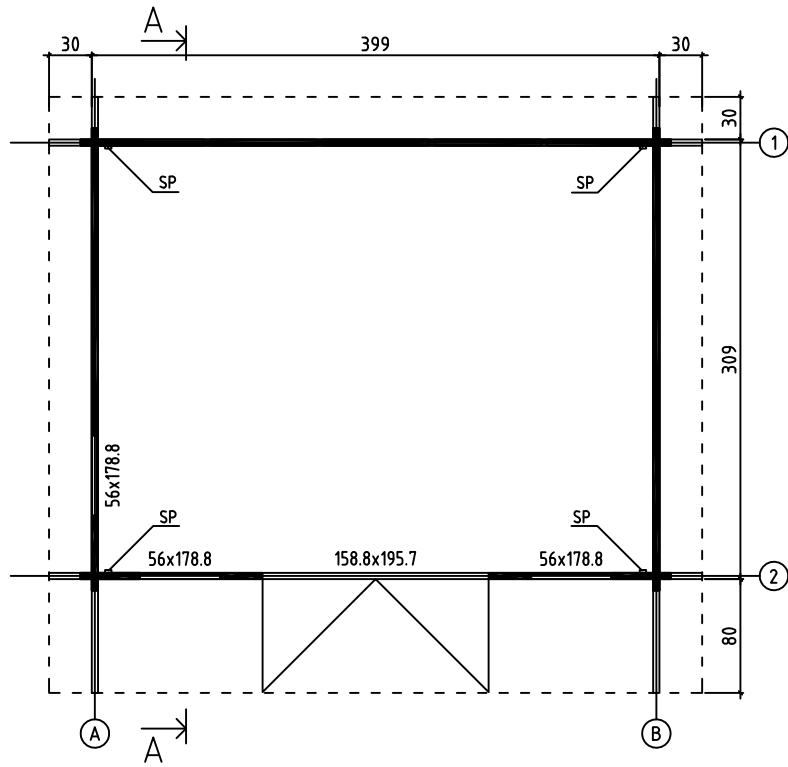

FOUNDATION - FUNDAMENT - FONDATION

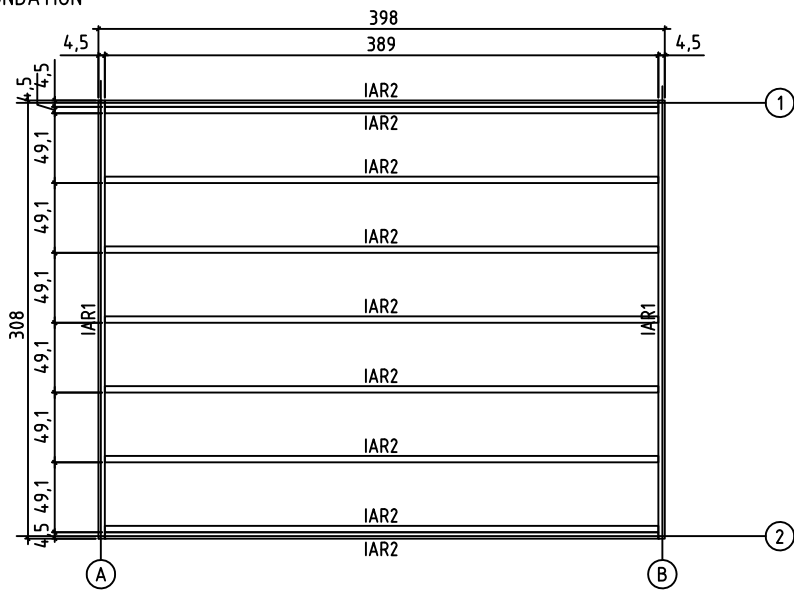



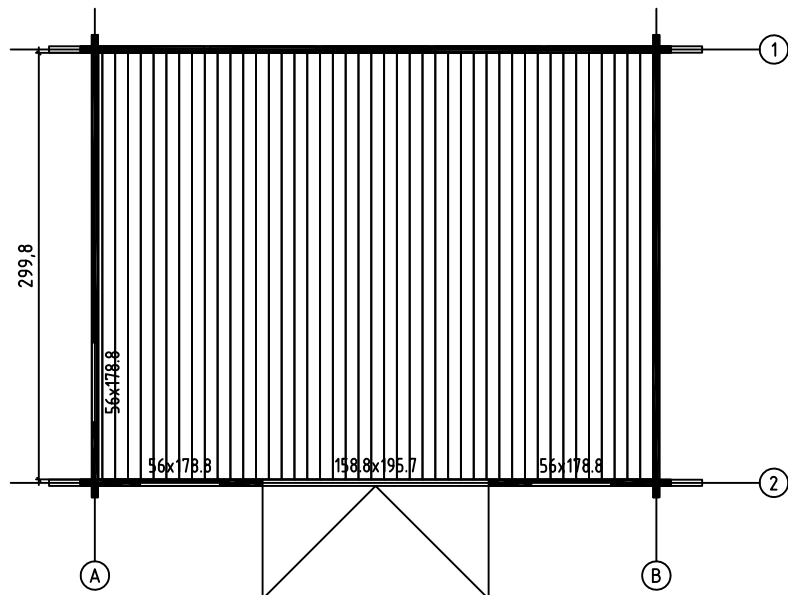

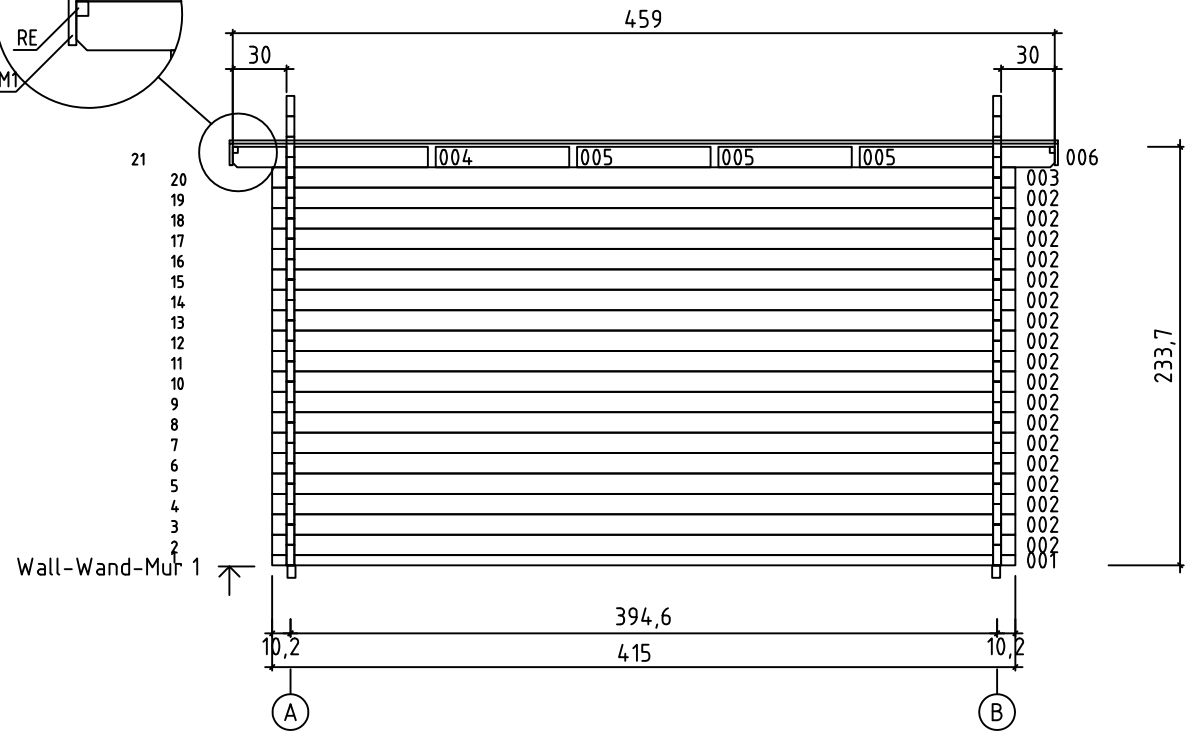
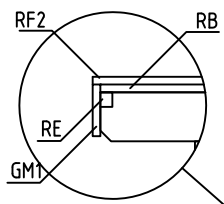
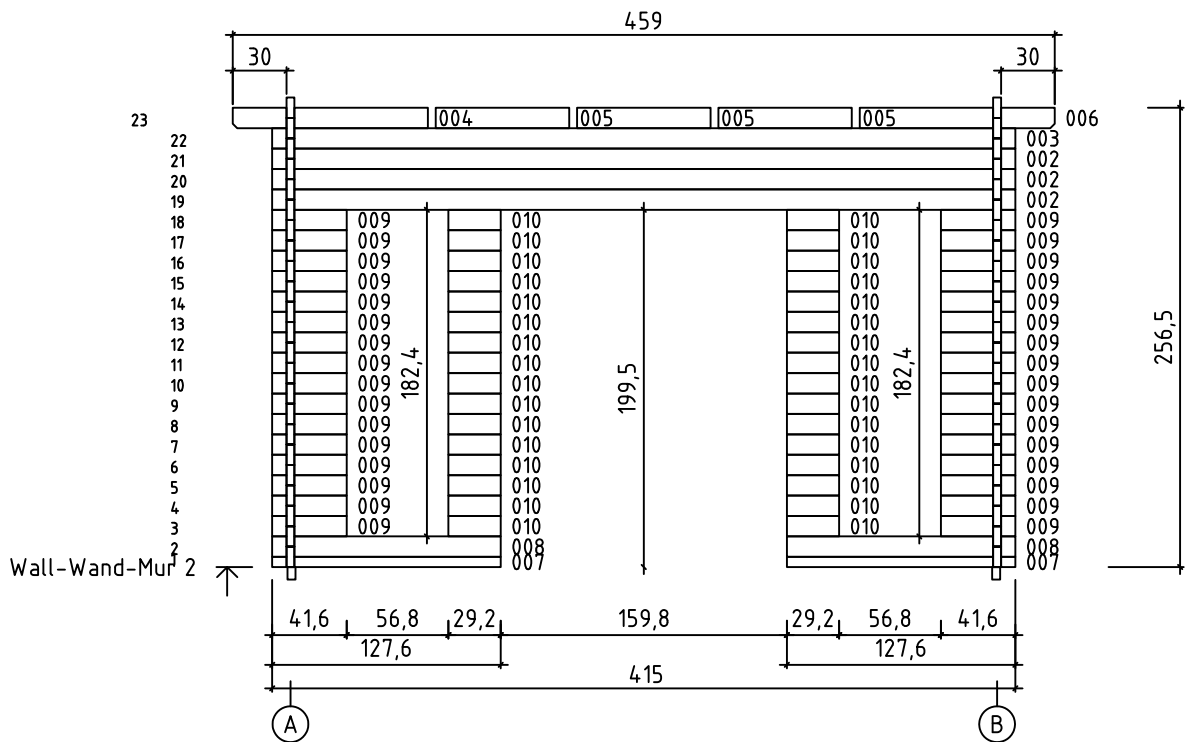

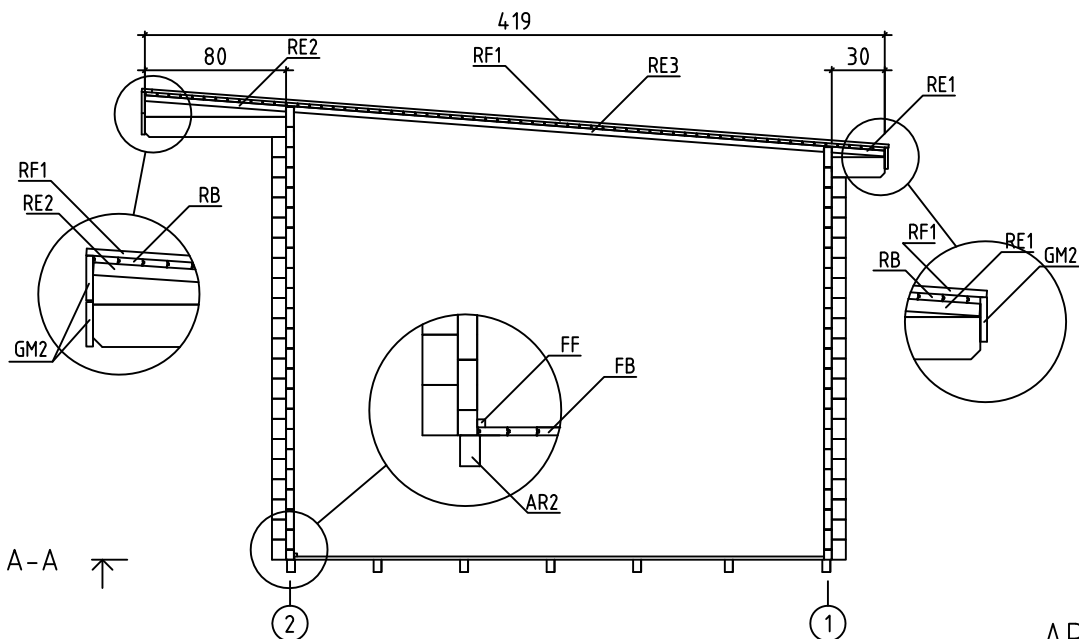
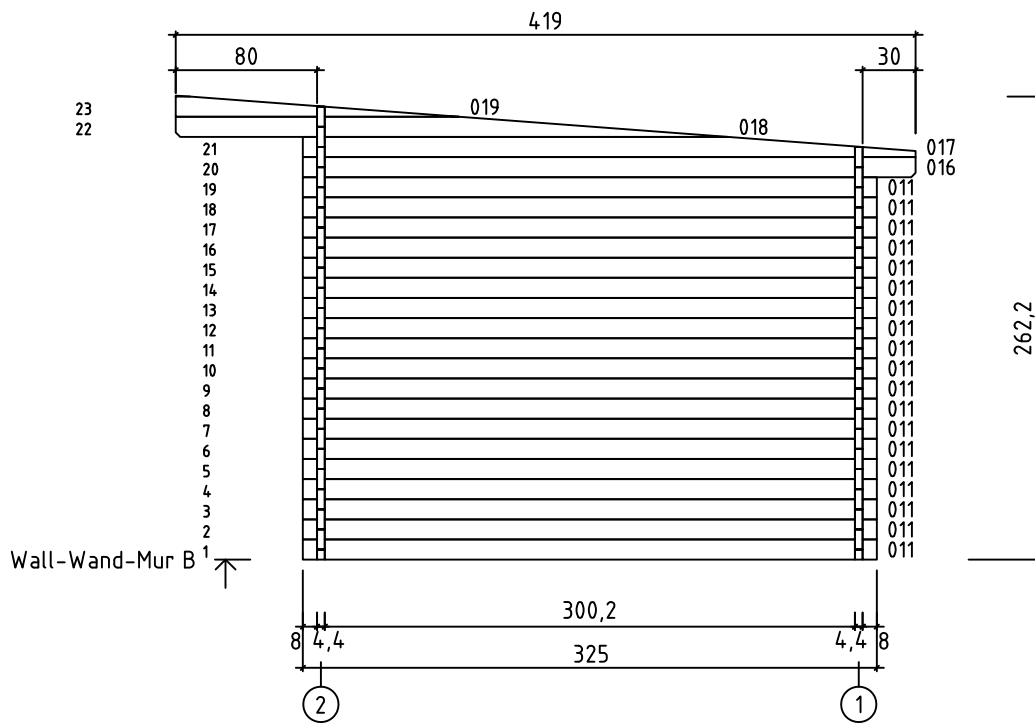
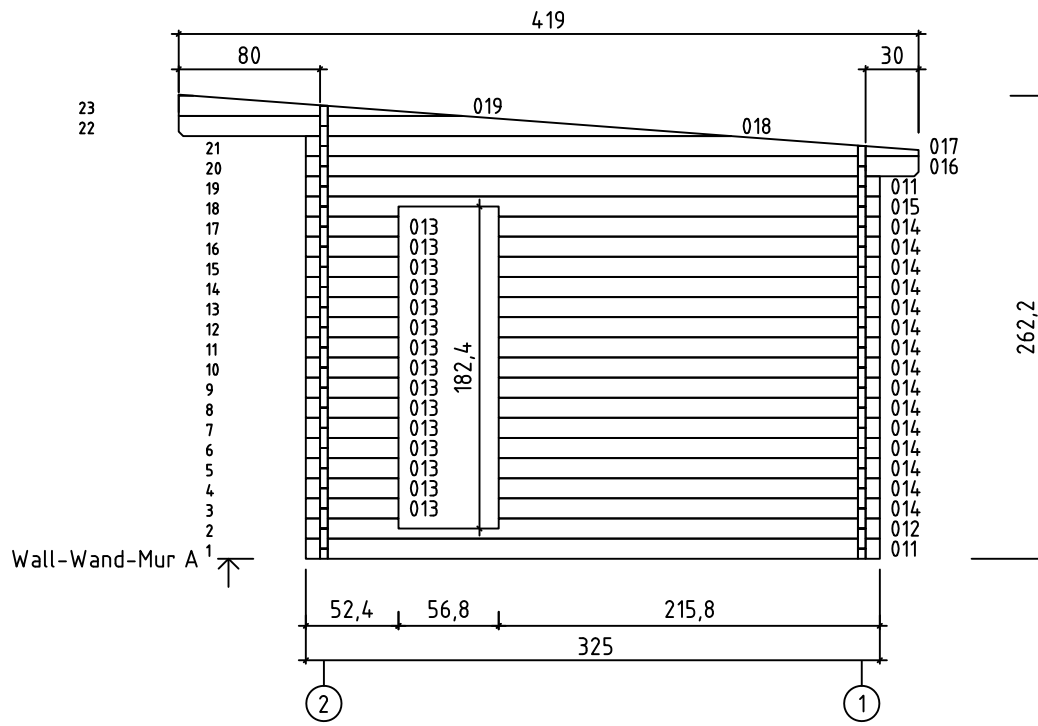

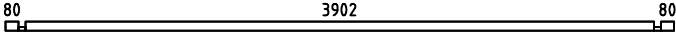
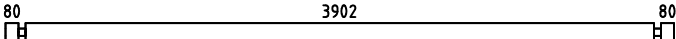
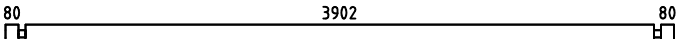
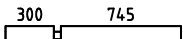
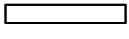
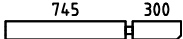
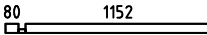
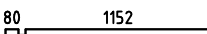

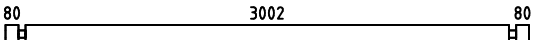
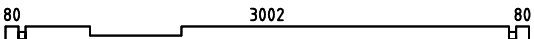

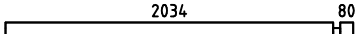
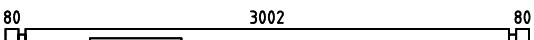
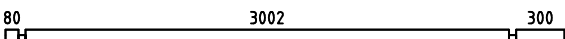
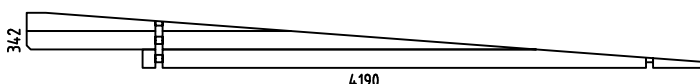
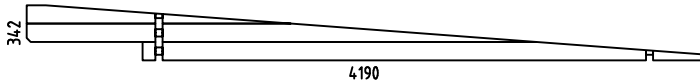

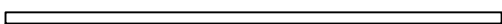
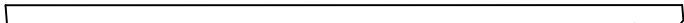





FLOOR BOARDS - FUSSBODENBRETTER - PLAN POSE PLANCHER



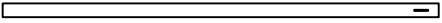
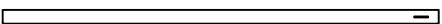
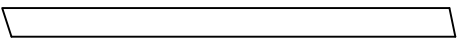
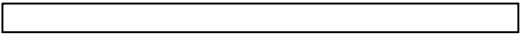

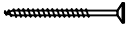
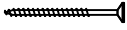
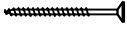
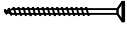
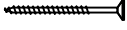
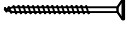
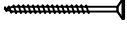
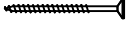
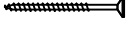
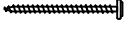

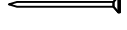



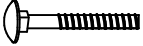

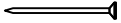
Pos	07.01.2011	ART.NR. 443711	5/7	Q.	P (mm)	L (mm)
001				1	44x57	4150
002				21	44x114	4150
003				2	44x114	4150
004				2	44x114	1089
005				6	44x114	745
006				2	44x114	1089
007				2	44x57	1276
008				2	44x114	1276
009				32	44x114	416
010				32	44x114	292
011				21	44x114	3250
012				1	44x114	3250
013				15	44x114	524
014				15	44x114	2158
015				1	44x114	3250
016				2	44x114	3470
WA-1				1		
WB-1				1		
IAR2	FOUNDATION - FUNDAMENT - FONDATION 			9	45x70	3890
IAR1	FOUNDATION - FUNDAMENT - FONDATION 			2	45x70	3080
SR1	ROOF BEAM - DACHBALKEN - PANNE DE TOIT 			4	44x140	4212
FB	FLOOR BOARDS - FUSSBODENBRETTER - LAME DE PLANCHER 			44	90x18	2998
RB	ROOF BOARDS - DACHBRETTER - VOLIGES 			47	90x18	4590
FF	FLOOR FILLET-FUSSBODENLEISTE - CORNIERE DE FINITION DU PLANCHER 				18x18	13.79

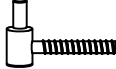
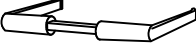
Pos	07.01.2011	ART.NR. 443711	6/7	Q.	P (mm)	L (mm)
RF1	ROOFING FELT FILLET - DACHPAPPENLEISTE - BAGUETTE DE FIXATION DU FEUTRE BITUMEUX			2	18x58	4185
RF2	ROOFING FELT FILLET - DACHPAPPENLEISTE - BAGUETTE DE FIXATION DU FEUTRE BITUMEUX			1	18x58	4630
RE1	ROOF EDGE REINFORCEMENT - DACHRANDVERSTÄRKUNG - CORNIERE DE RENFORT DE BORD DE TOIT			2	28x34	300
RE2	ROOF EDGE REINFORCEMENT - DACHRANDVERSTÄRKUNG - CORNIERE DE RENFORT DE BORD DE TOIT			2	28x34	800
RE3	ROOF EDGE REINFORCEMENT - DACHRANDVERSTÄRKUNG - CORNIERE DE RENFORT DE BORD DE TOIT			2	28x34	3005
SP	STORM PROTECTION - STURMLEISTE - LATTE ANTI-TEMPETE			2	22x45	2250
SP	STORM PROTECTION - STURMLEISTE - LATTE ANTI-TEMPETE			2	22x45	2480
GM1	GABLE MOULDING - GIEBELLEISTE - PLANCHE DE RIVE			2	18x120	4212
GM2	GABLE MOULDING - GIEBELLEISTE - PLANCHE DE RIVE			3	18x120	4630
	WINDOW HANDLE FITTINGS-FENSTERGRIFF - POIGNÉE D'OUVERTURE DE FENETRE			6		
	SCREW FOR GABLE MOULDING - SCHRAUBEN FÜR GIEBELLEISTE - VIS DE FIXATION POUR PLANCHE DE RIVE			60	3.5x50	
	SCREW FOR FILLET - SCHRAUBE ZUR BEFESTIGUNG TÜRLEISTE - VIS D'ASSEMBLAGE DU CADRE DE PORTE			5	3x30	
	SCREW FOR ROOF EDGE REINFORCEMENT - SCHRAUBEN FÜR DACHRANDVERSTÄRKUNG - VIS POUR RENFORT DE BORD DE TOIT			22	4x40	
	SCREW FOR ROOF BEAMS - SCHRAUBEN FÜR DACHBALKEN - VIS POUR PANNE DE TOIT			12	5x120	
	SCREW FOR GABLE - SCHRAUBEN FÜR GIEBEL - VIS POUR FIXATION DES PIGNONS			6	5x120	
	SCREW FOR Pos. 004, 005 - SCHRAUBEN FÜR für Pos. 004, 005 VIS POUR FIXATION DERNIÈRE RANGÉE MADRIERS (MURS AVANT ET ARRIÈRE)			10	6x180	
	SCREW FOR 1. WALL BEAM - SCHRAUBE FÜR 1. BOHLENREIHE - VIS DE FIXATION DES FONDATIONS			8	5x90	
	SCREW FOR FUNDAMENT - SCHRAUBEN ZUR BEFISTIGUNG FUNDAMENT - VIS POUR FONDATION			22	5x90	
	SCREW FOR DOOR JAMB - SCHRAUBE FÜR TÜRRAHMEN - VIS DE FIXATION POUR MONTANT DE PORTE			4	5x90	
	SCREW FOR DOORSTEP - SCHRAUBEN FÜR TÜRSWELLE - VIS DE FIXATION DU SEUIL DE PORTE			3	4.5x65	
	ZN NAIL FOR FLOOR FILLET - ZN NÄGEL FÜR FUSSBODENLEISTE - POINTE POUR CORNIERE DE FINITION DU PLANCHER			28	1.4x40	
	HAMMER BLOCK - SCHLAGHOLZ - CALLE DE FRAPPE			1		
	ZN NAIL FOR ROOFING FELT FILLET - ZN NÄGEL FÜR DACHPAPPENLEISTE - POINTE POUR BAGUETTE FIXATION FEUTRE BITUMEUX			28	2x40	
	BOLT FOR WINDOW HANDLE FITTINGS - BOLZEN FÜR FENSTERGRIFF BESCHLAG - BOULON POUR POIGNÉE D'OUVERTURE DE FENETRE			12		
	NUT FOR STORM PROTECTION - SCHRAUBENMUTTER FÜR STURMLEISTE - ÉCROU POUR LAME ANTI-TEMPETE			8		

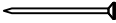
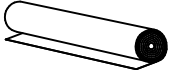
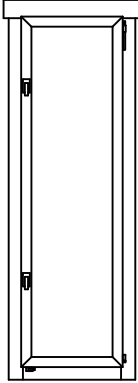
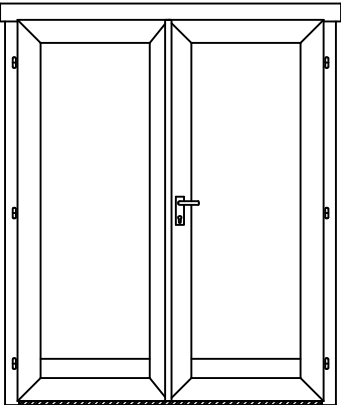
Pos	07.01.2011	ART.NR. 443711	7/7	Q.	P (mm)	L (mm)
	BOLT FOR STORM PROTECTION - BOLZEN FÜR STURMLEISTE - VIS POUR LAME ANTI-TEMPETE			8		
	WASHER FOR STORM PROTECTION - DICHTSCHEIBE FÜR STURMLEISTE - RONDELLE POUR LAME ANTI-TEMPETE			8		
	ZN NAIL FOR ROOF - ZN NÄGEL FÜR DACHBRETTER - POINTE POUR TOIT			300	2x50	
	ZN NAIL FOR FLOOR - ZN NÄGEL FÜR FUSSBODENBRETTER - CLOUS POUR PLANCHER			315	2x50	
	SET OF DOOR LOCK COVERS - SCHLOSSBLENDEN - SET DE GARNITURES DE SERRURE DE PORTE			1		
	MALE BOLT HINGE FOR DOOR - TÜRRIEGEL - PARTIE MALE DE CHARNIERE DE PORTE			6		
	DOOR HANDLE FITTINGS-TÜRGRIF - SET DE GARNITURES DE SERRURE DE PORTE			1		
	CYLINDER -ZYLINDERSCHLOSS - CYLINDRE DE SERRURE			1		
	ROOFING NAILS FOR ROOFING FELT - NÄGEL FÜR DACHPAPPE - POINTE DE FIXATION POUR FEUTRE BITUMEUX			190	2x17	
	ROOFING FELT - DACHPAPPE - FEUTRE BITUMEUX			5		4690
	WINDOW-FENSTER-FENETRE 560x1788		AK.1.100.PSP	3		
	DOOR-TÜR-PORTE 1588x1957		TUK.1.100.PVP.MM	1		