

Art.Nr. 285100

1/8

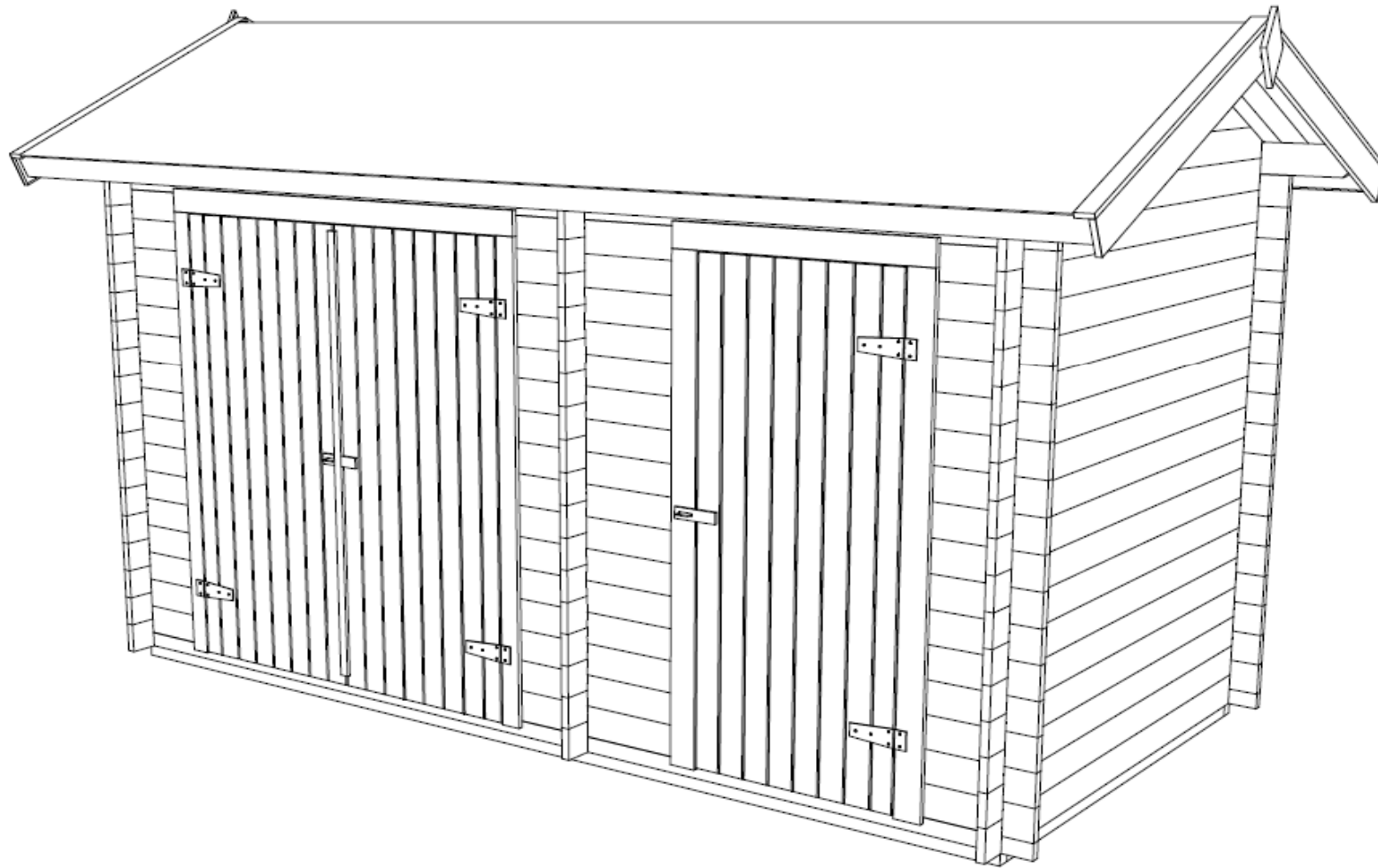

07.12.2010

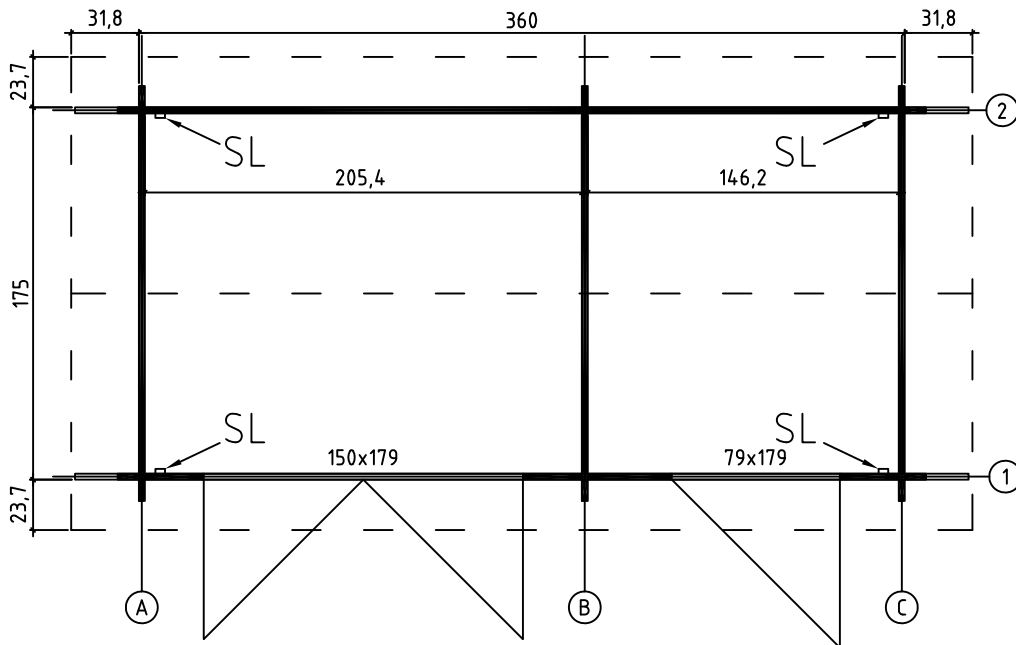

GROUNDPLAN - GRUNDPLAN - PLAN DE MASSE

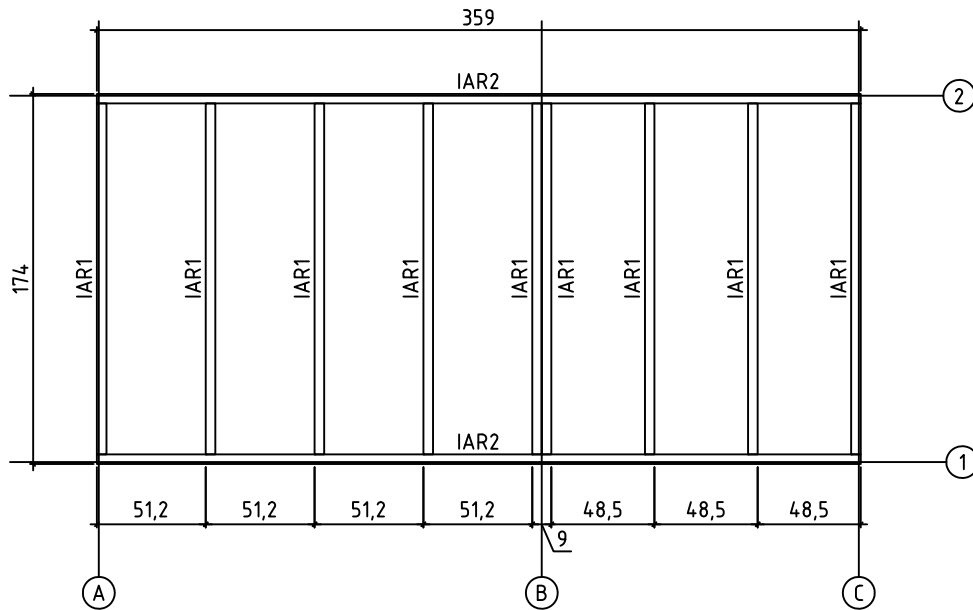

FOUNDATION - FUNDAMENT - FONDATION

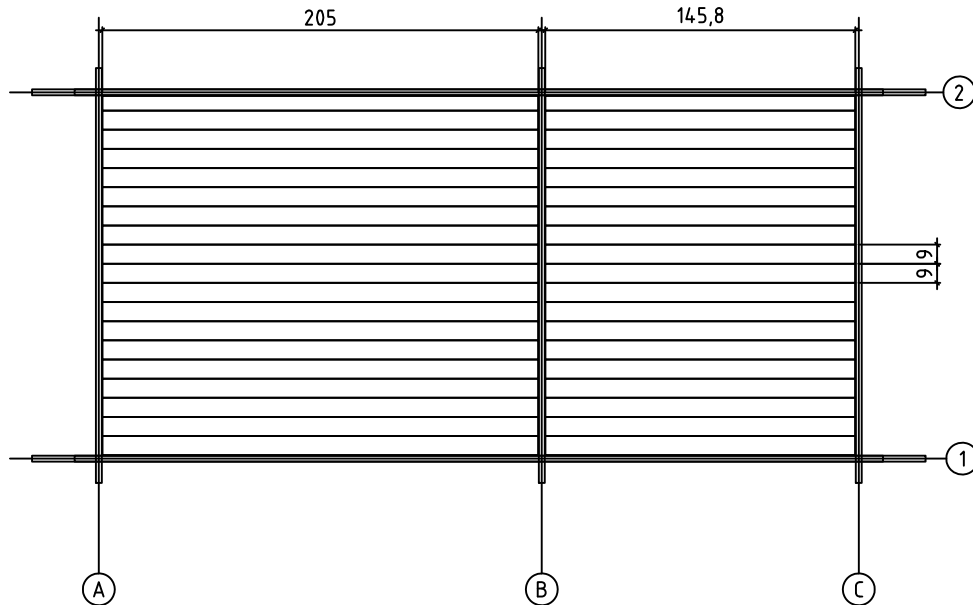

FLOOR BOARDS -FUSSBODENBRETTER - PLAN POSE PLANCHER

Art.Nr. 285100

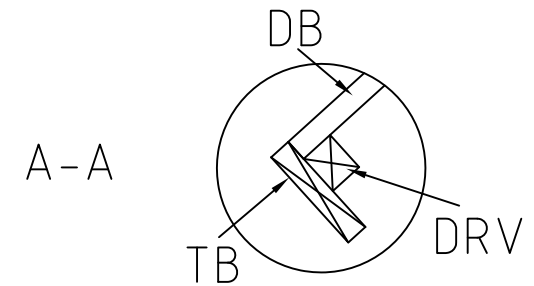
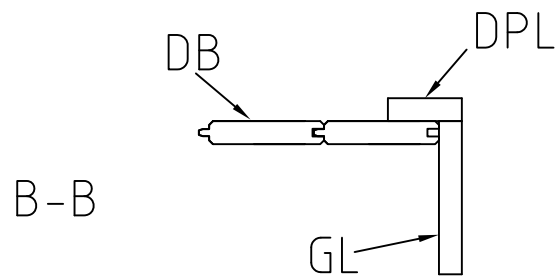
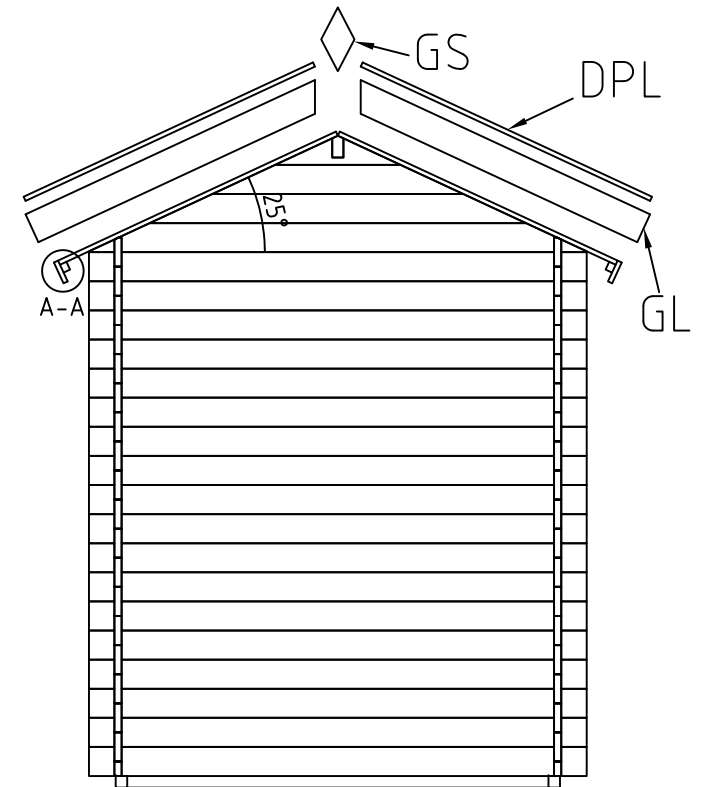
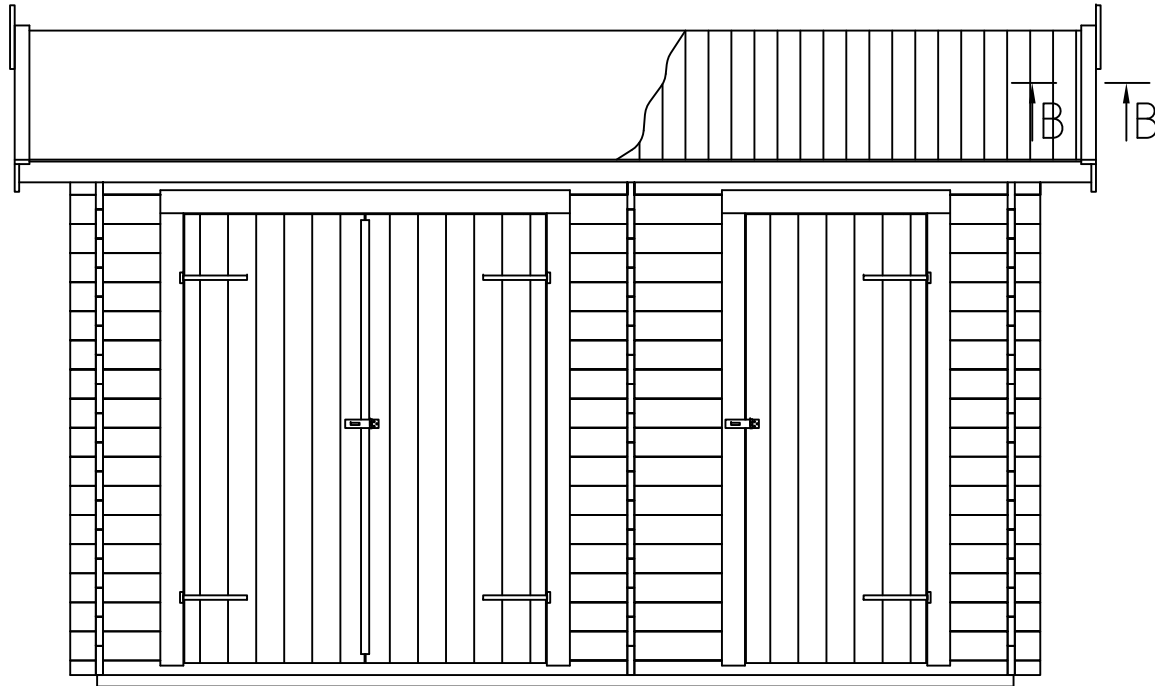

15.02.2013





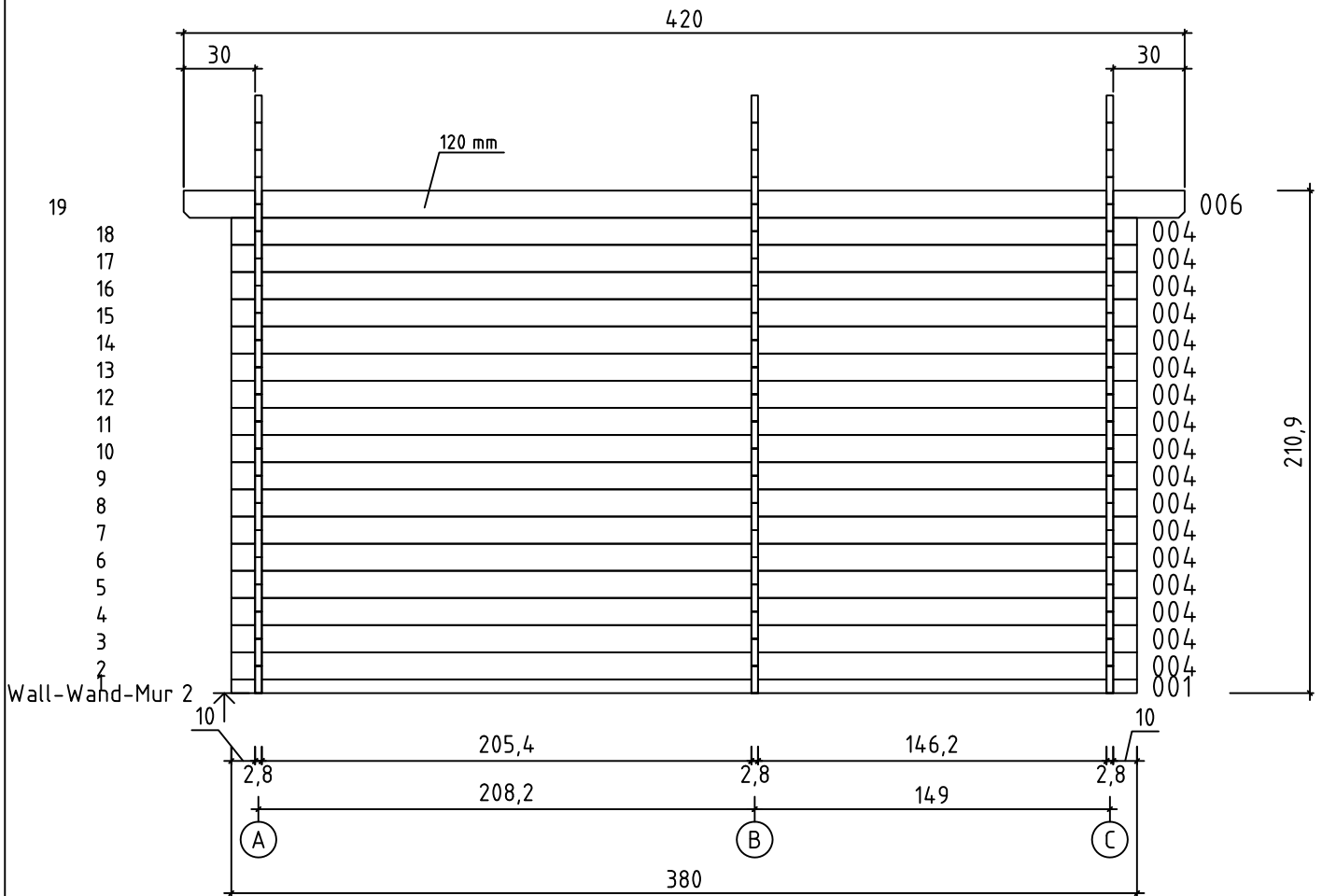
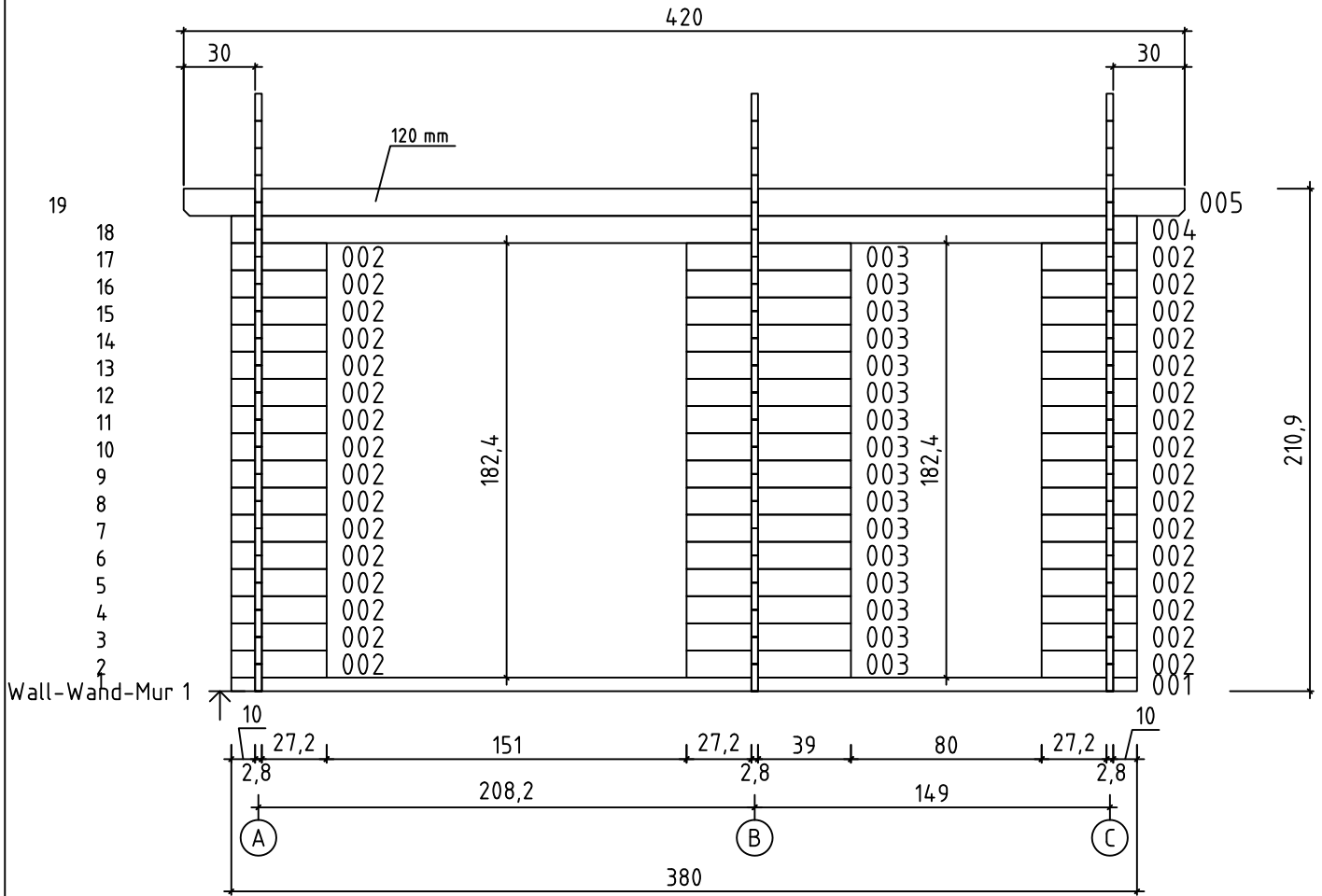



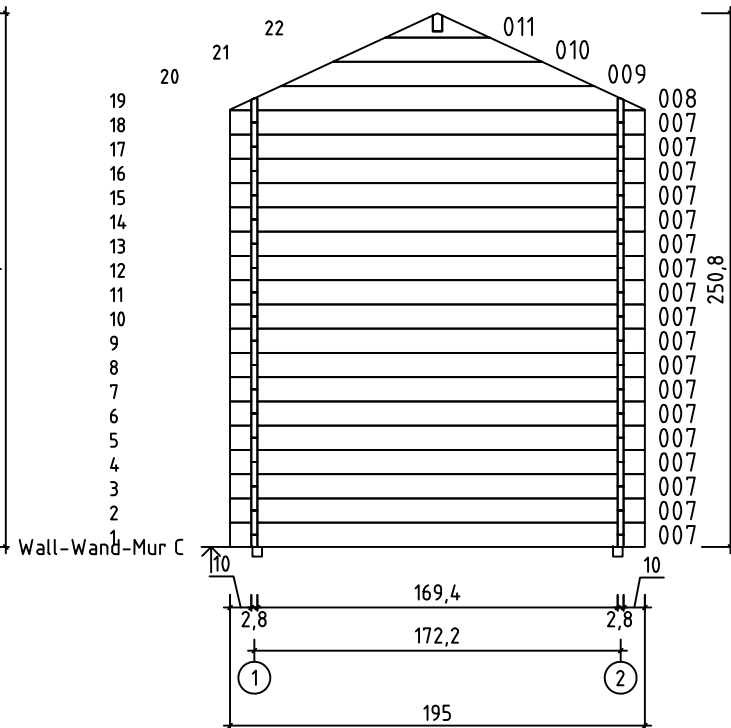
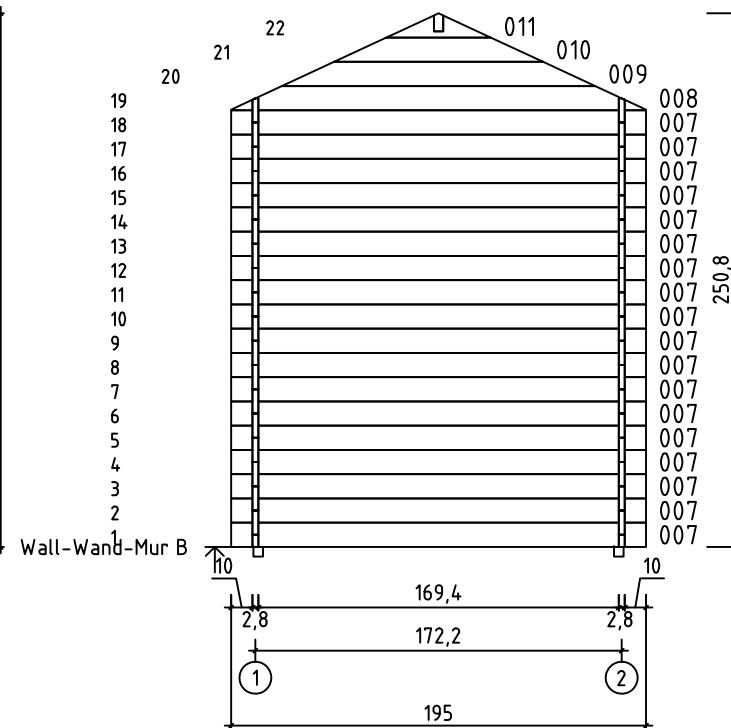
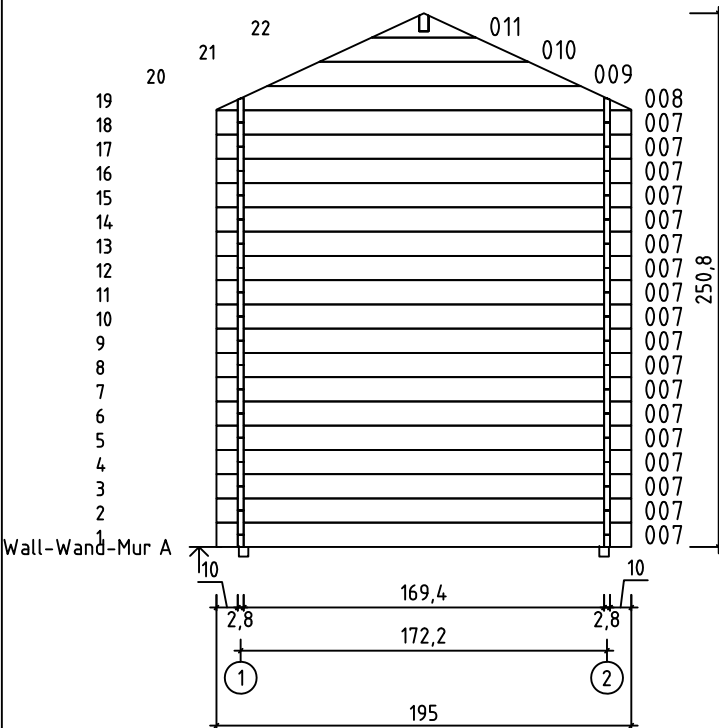

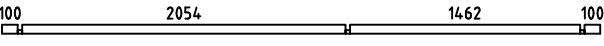

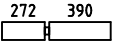
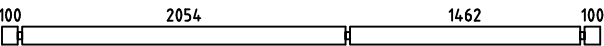
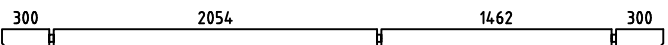
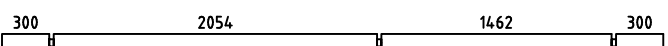
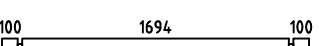
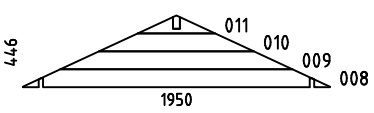
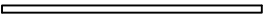

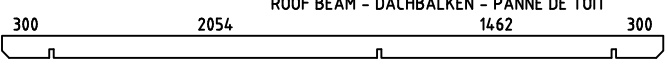
3/8

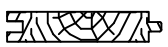

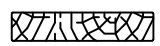

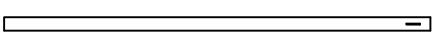
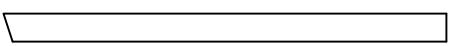



# Art.Nr. 285100

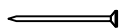
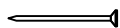
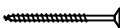
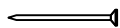
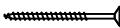
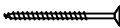
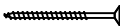

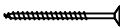
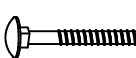
Art.Nr. 285100

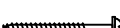
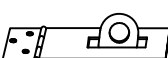

Pos	15.02.2013	Piecelist - Stücklist - Liste des composants Art.Nr. 285100	6/8	Q.	P. (mm)	L. (mm)
001				2	28x57	3800
002				32	28x114	400
003				16	28x114	690
004				18	28x114	3800
005				1	28x120	4200
006				1	28x120	4200
007				54	28x114	1950
WA-1 WB-1 WC-1				3		
IAR1		FOUNDATION - FUNDAMENT - FONDATION 		9	45x45	1650
IAR2		FOUNDATION - FUNDAMENT - FONDATION 		2	45x45	3590
PR1		ROOF BEAM - DACHBALKEN - PANNE DE TOIT 		1	44x140	4200
		FLOOR BOARDS - FUSSBODENBRETTER - LAME DE PLANCHER 		19	90x18	2050
		FLOOR BOARDS - FUSSBODENBRETTER - LAME DE PLANCHER 		19	90x18	1458
DB		ROOF BOARDS - DACHBRETTER - VOLIGES 		94	90x18	1200
		FLOOR FILLET-FUSSBODENLEISTE - CORNIERE DE FINITION DU PLANCHER 			18x18	13.78
DPL		ROOFING FELT FILLET - DACHPAPPENLEISTE - - BAGUETTE DE FIXATION DU FEUTRE BITUMEUX 		4	18x58	1250
TB		EAVES BOARD - TRAUFBRETT - BANDEAU DE TOIT 		2	18x90	4200
DRV		ROOF EDGE REINFORCEMENT - DACHRANDVERSTÄRKUNG - - CORNIERE DE RENFORT DE BORD DE TOIT 		2	28x34	4200
SL		STORM PROTECTION - STURMLEISTE - - LATTE ANTI-TEMPETE 		4	22x45	2100
GL		GABLE MOULDING - GIBELLEISTE - - PLANCHE DE RIVE 		4	18x120	1250
GS		GABLE SEGMENT-DECKBLATT - LOSANGE DE FINITION 		2		
		HAMMER BLOCK - SCHLAGHOLZ - CALLE DE FRAPPE 28mm 		1		300
		SCREW FOR FUNDAMENT - SCHRAUBEN ZUR BEFESTIGUNG FUNDAMENT - - VIS POUR FONDATION 		19	5x90	
		SCREW FOR 1. WALL BEAM - SCHRAUBE FÜR 1. BOHLENREIHE - - VIS DE FIXATION DES FONDATIONS 		6	5x90	

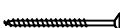
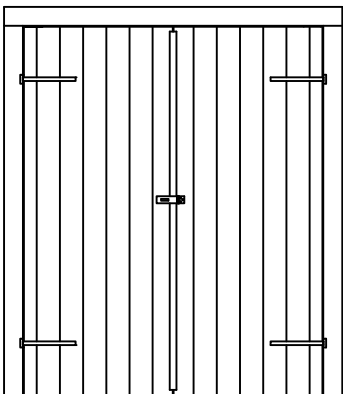
Pos	15.02.2013	Piecelist - Stücklist - Liste des composants Art.Nr. 285100	7/8	Q.	P. (mm)	L. (mm)
		ZN NAIL FOR FLOOR - ZN NÄGEL FÜR FUSSBODENBRETTER - - CLOUS POUR PLANCHER		180	2x50	
		ZN NAIL FOR FLOOR FILLET - ZN NÄGEL FÜR FUSSBODENLEISTE - - POINTE POUR CORNIERE DE FINITION DU PLANCHER		28	1.4x40	
		SCREW FOR ROOF BEAMS - SCHRAUBEN FÜR DACHBALKEN - - VIS POUR PANNE DE TOIT		9	5x120	
		ZN NAIL FOR ROOF - ZN NÄGEL FÜR DACHBRETTER - - POINTE POUR TOIT		196	2x50	
		SCREW FOR EAVES BOARDS - SCHRAUBEN FÜR TRAUFBRETTER - - VIS DE FIXATION POUR BANDEAU DE TOIT		18	4x40	
		SCREW FOR ROOF EDGE REINFORCEMENT - SCHRAUBEN FÜR DACHRANDVERSTÄRKUNG - VIS POUR RENFORT DE BORD DE TOIT		18	4x40	
		SCREW FOR GABLE MOULDING - SCHRAUBEN FÜR GIEBELLEISTE - - VIS DE FIXATION POUR PLANCHE DE RIVE		16	3.5x50	
		ZN NAIL FOR ROOFING FELT FILLET - ZN NÄGEL FÜR DACHPAPPENLEISTE - POINTE POUR BAGUETTE FIXATION FEUTRE BITUMEUX		16	2x40	
		SCREW FOR GABLE SEGMENT - SCHRAUBEN FÜR DECKBLATT - - VIS POUR FIXATION LOSANGE DE FINITION		4	3.5x35	
		BOLT FOR STORM PROTECTION - BOLZEN FÜR STURMLEISTE - - VIS POUR LAME ANTI-TEMPETE		8		
		WASHER FOR STORM PROTECTION - DICHTSCHEIBE FÜR STURMLEISTE - - RONDELLE POUR LAME ANTI-TEMPETE		8		
		NUT FOR STORM PROTECTION - SCHRAUBENMUTTER FÜR STURMLEISTE - ÉCROU POUR LAME ANTI-TEMPETE		8		
		SCREW FOR DOOR JAMB - SCHRAUBE FÜR TÜRRAHMEN - - VIS DE FIXATION POUR MONTANT DE PORTE		4	4x40	
		SCREW FOR PADLOCK HASP - SCHRAUBEN FÜR PANZER ÜBERFALLE - - VIS DE FIXATION LOQUET POUR CADENAS		14	3.5x20	
		PADLOCK HASP - PANZER ÜBERFALLE - LOQUET POUR CADENAS		2		115
		HINGE FOR DOOR - TÜRRIEGEL - CHARNIERE DE PORTE		4		230
		SCREW FOR FILLET - SCHRAUBE ZUR BEFESTIGUNG TÜRLEISTE - - VIS D'ASSEMBLAGE DU CADRE DE PORTE		5	3x30	
		DOOR - TÜR - PORTE 1500x1790		TUL.1.100.IVP.Md	1	

