

BORKUM 6
ART.NR. 406200
1/8

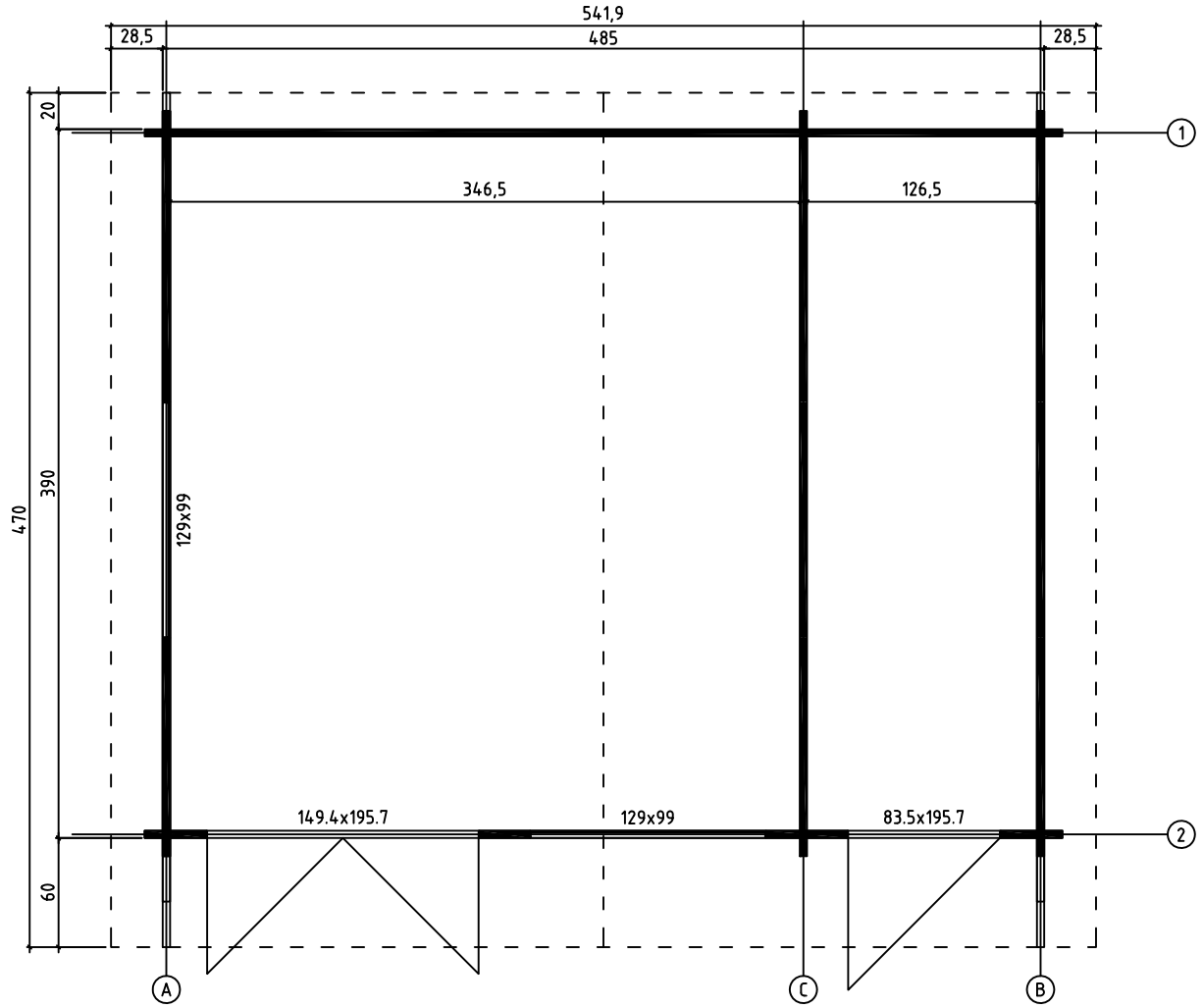

GROUNDPLAN - GRUNDPLAN - PLAN DE MASSE



FOUNDATION - FUNDAMENT - FONDATION

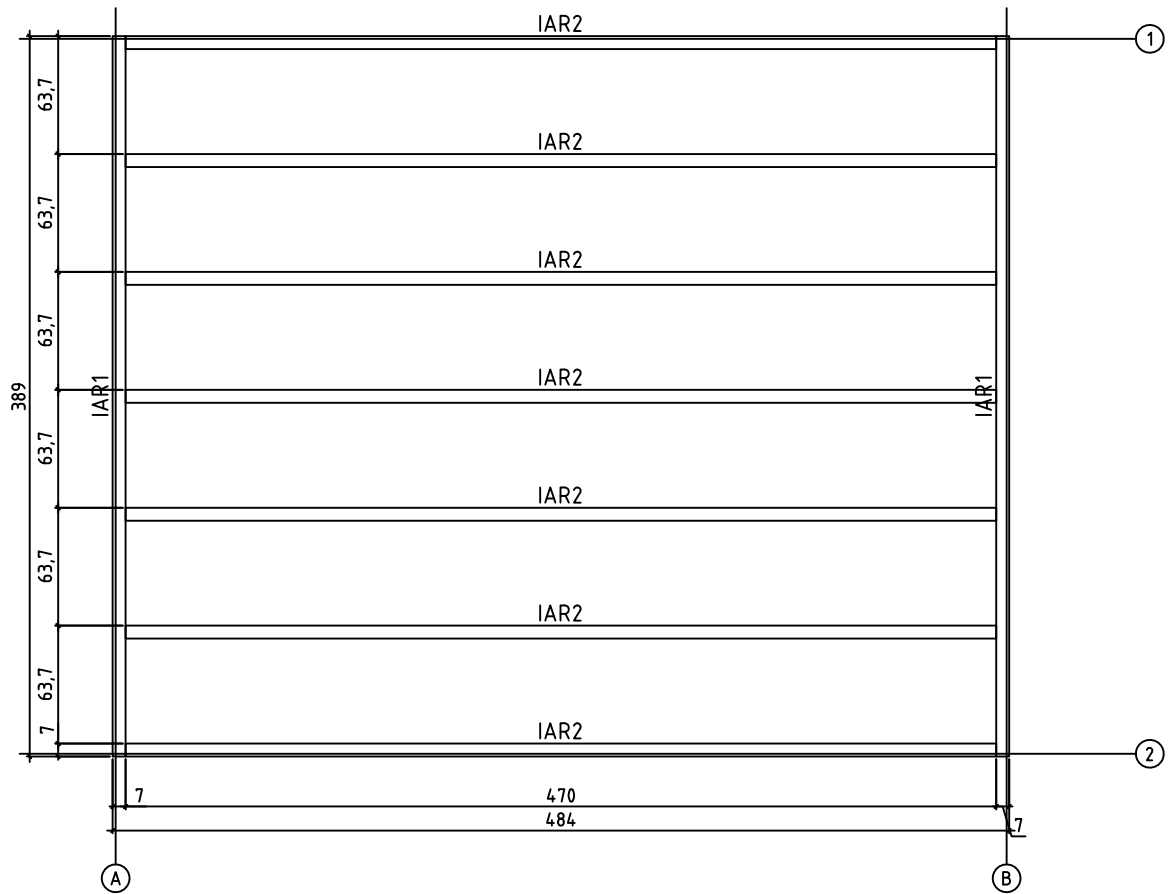



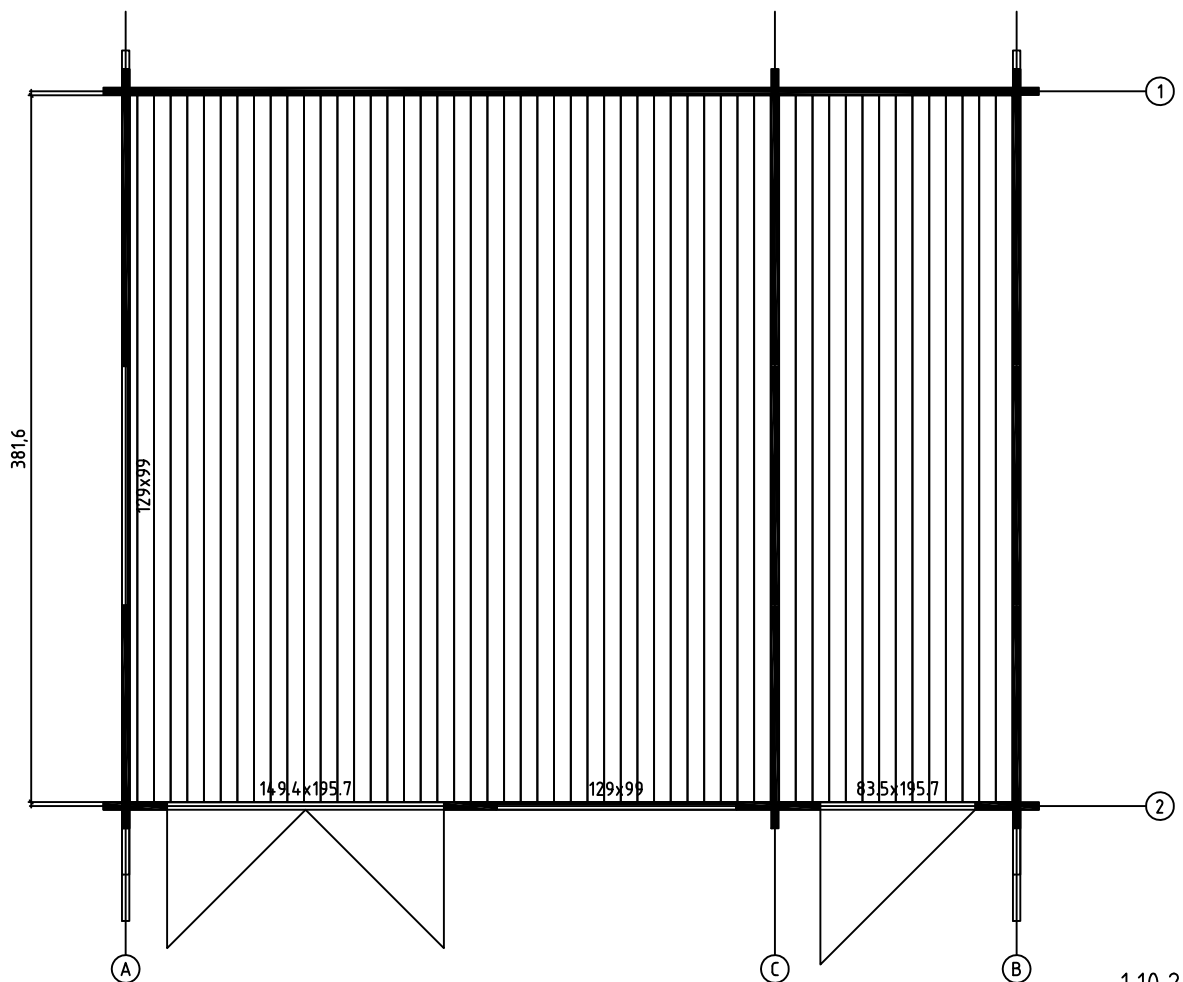

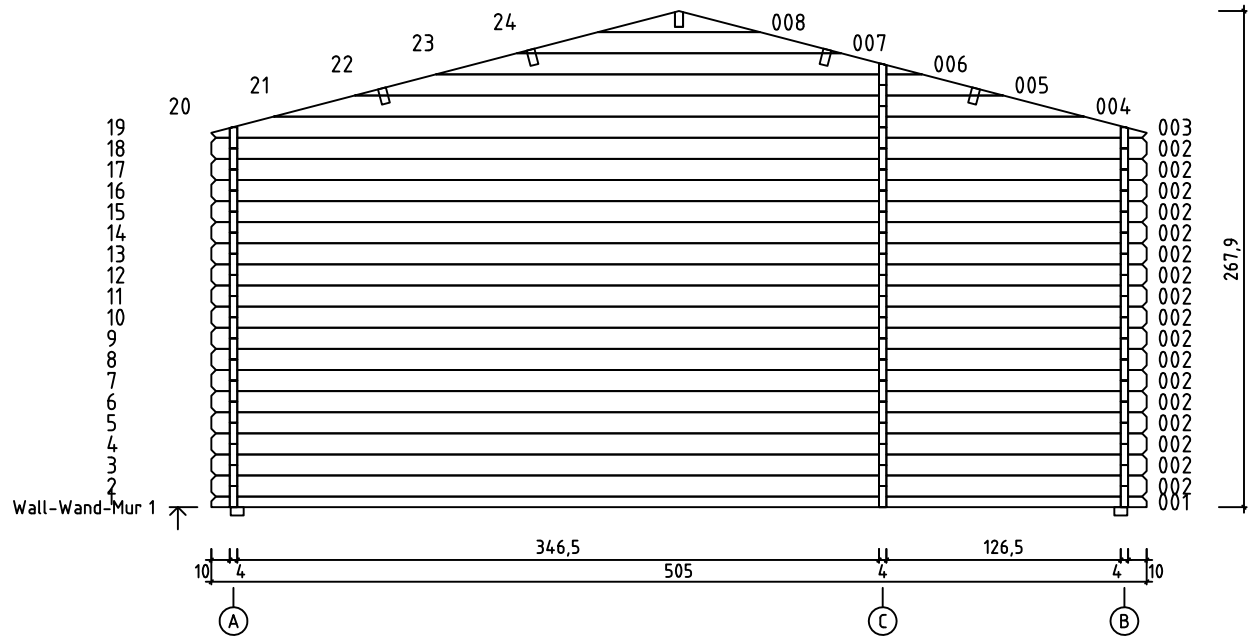
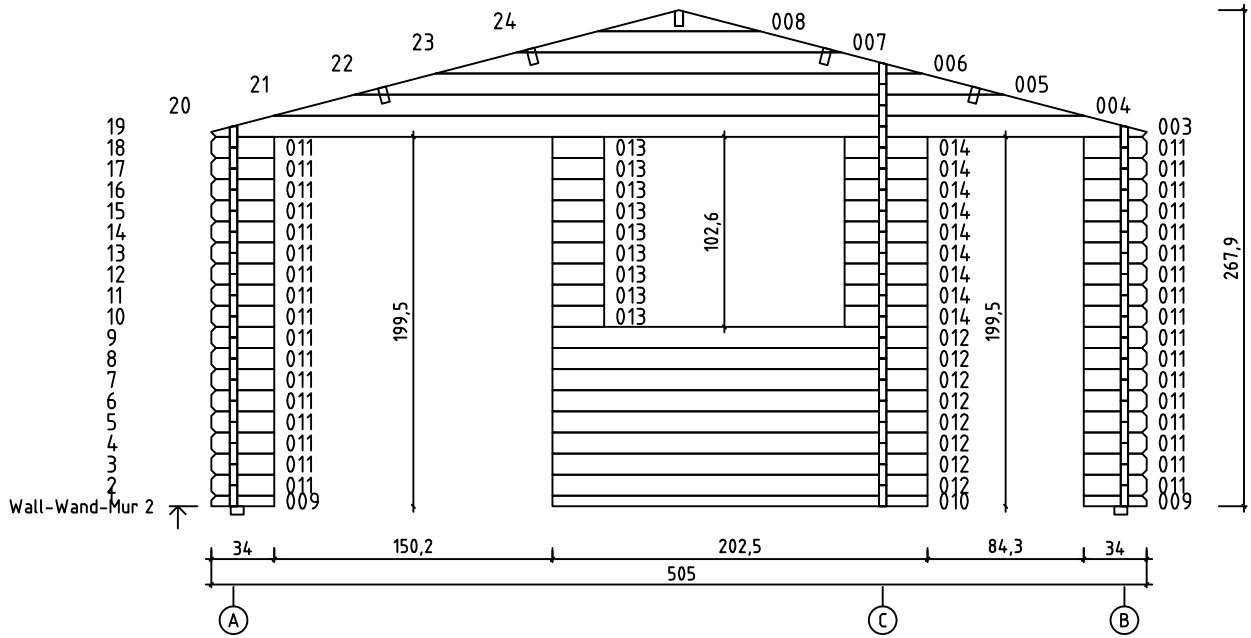

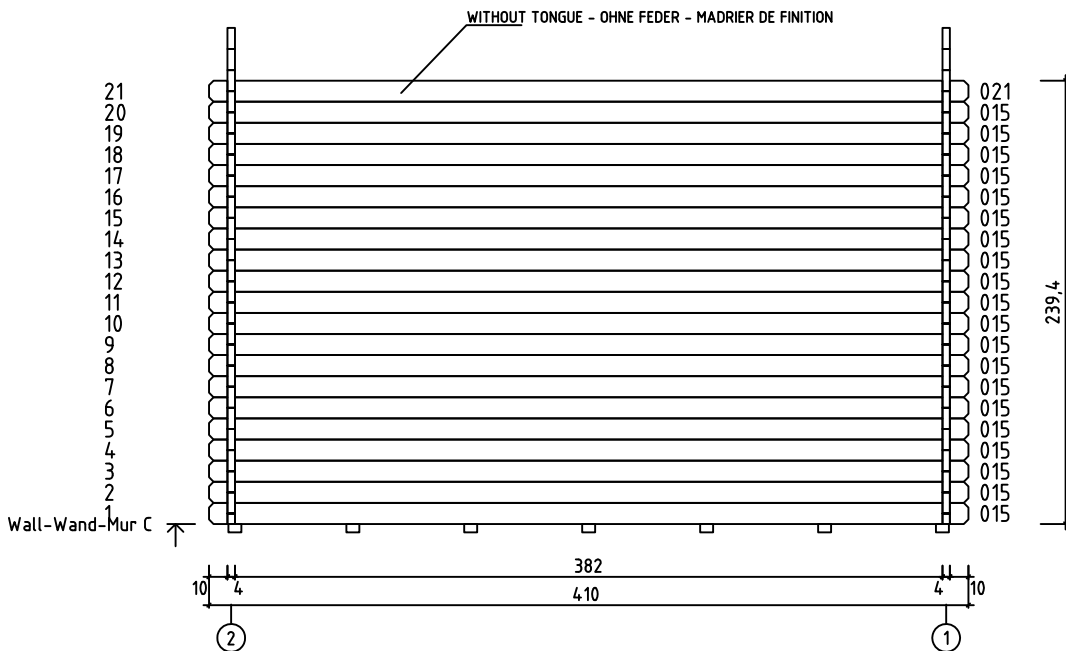
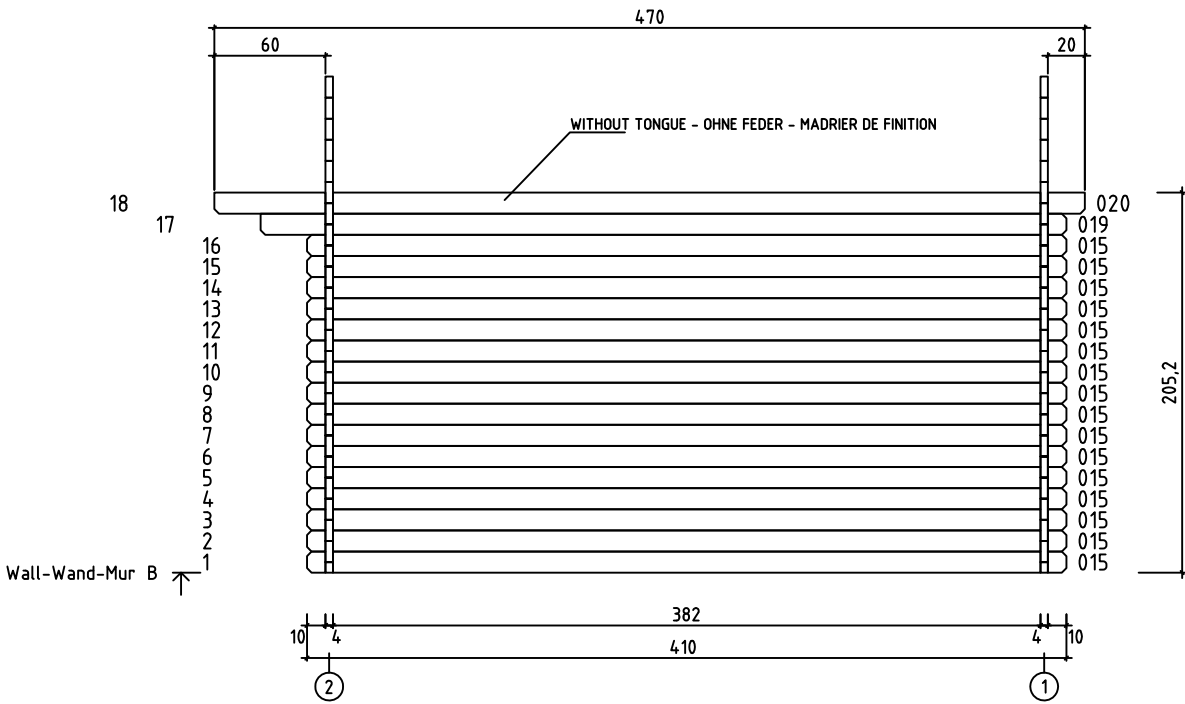
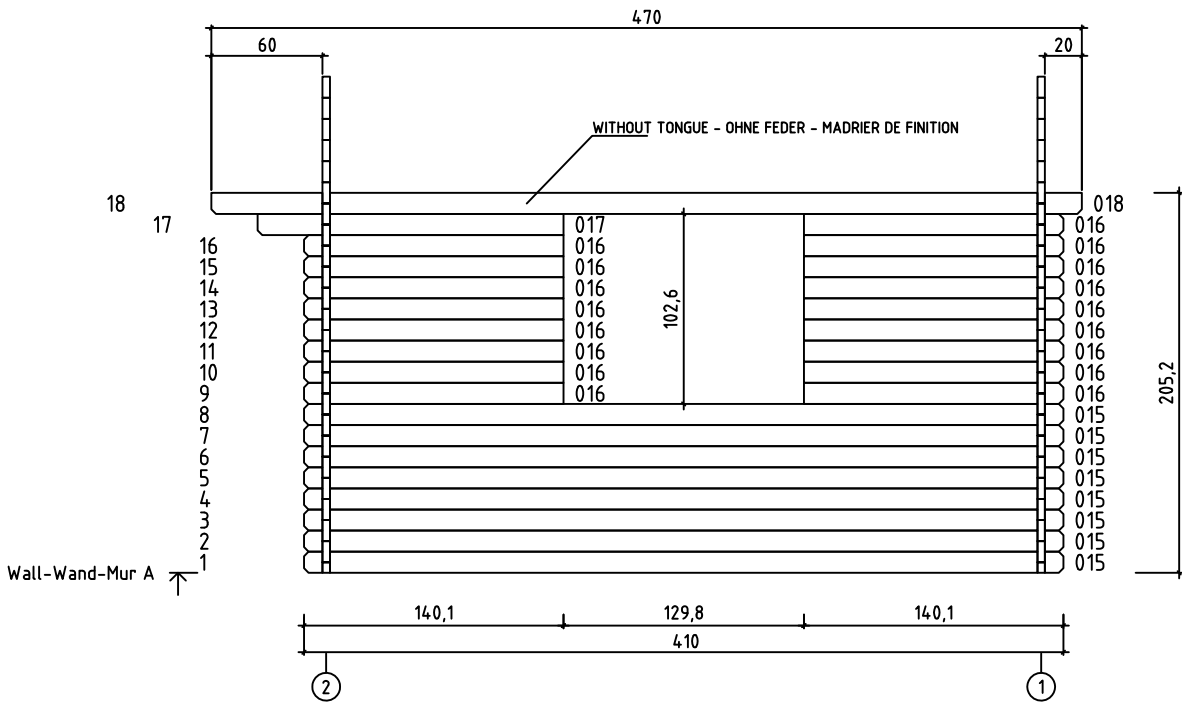







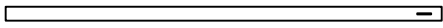
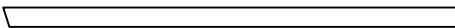

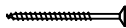
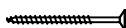
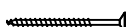
FLOOR BOARDS - FUSSBODENBRETTER - PLAN POSE PLANCHER





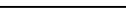
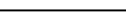

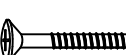

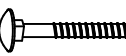

Pos	1.10.2012	ART.NR. 406200	6/8	Q.	P (mm)	L (mm)
001				1	40x57	5050
002				17	40x114	5050
009				2	40x57	340
010				1	40x57	2025
011				34	40x114	340
012				8	40x114	2025
013				9	40x114	279
014				9	40x114	448
015				44	40x114	4100
016				17	40x114	1401
017				1	40x114	1651
018				1	40x114	4700
019				1	40x114	4350
020				1	40x114	4700
021				1	40x114	4100
W1-1				1		
W2-1				1		
IAR2	FOUNDATION - FUNDAMENT - FONDATION 			7	70x45	4700
IAR1	FOUNDATION - FUNDAMENT - FONDATION 			2	70x45	3890
PPR1	ROOF BEAM - DACHBALKEN - PANNE DE TOIT 			1	44x140	4700
PR21	ROOF BEAM - DACHBALKEN - PANNE DE TOIT 			4	44x140	4700
	FLOOR BOARDS - FUSSBODENBRETTER - LAME DE PLANCHER 			54	90x18	3816
	ROOF BOARDS - DACHBRETTER - VOLIGES 			106	90x18	2800

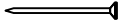
Pos	1.10.2012	ART.NR. 406200	7/8	Q.	P (mm)	L (mm)
	FLOOR FILLET-FUSSBODENLEISTE - CORNIERE DE FINITION DU PLANCHER				18x18	24.71
	ROOFING FELT FILLET - DACHPAPPENLEISTE - BAGUETTE DE FIXATION DU FEUTRE BITUMEUX			4	18x58	2850
	EAVES BOARD - TRAUFBRETT - BANDEAU DE TOIT			2	18x90	4700
	ROOF EDGE REINFORCEMENT - DACHRANDVERSTÄRKUNG - CORNIERE DE RENFORT DE BORD DE TOIT			2	28x34	4700
	STORM PROTECTION - STURMLEISTE LATTE ANTI-TEMPETE			4	22x45	2000
	GABLE MOULDING - GIEBELLEISTE PLANCHE DE RIVE			4	18x120	2850
	WINDOW HANDLE FITTINGS-FENSTERGRIFF - POIGNÉE D'OUVERTURE DE FENETRE			2		
	SCREW FOR GABLE SEGMENT - SCHRAUBEN FÜR DECKBLATT - VIS POUR FIXATION LOSANGE DE FINITION			4	3x35	
	SCREW FOR GABLE MOULDING - SCHRAUBEN FÜR GIEBELLEISTE - VIS DE FIXATION POUR PLANCHE DE RIVE			32	3.5x50	
	SCREW FOR DOOR FILLET - SCHRAUBE ZUR BEFESTIGUNG TÜRLEISTE - VIS D'ASSEMBLAGE DU CADRE DE PORTE			5	3x30	
	SCREW FOR EAVES BOARDS - SCHRAUBEN FÜR TRAUFBRETT - VIS DE FIXATION POUR BANDEAU DE TOIT			20	4x40	
	SCREW FOR ROOF EDGE REINFORCEMENT - SCHRAUBEN FÜR DACHRANDVERSTÄRKUNG - VIS POUR RENFORT DE BORD DE TOIT			20	4x40	
	SCREW FOR ROOF BEAMS - SCHRAUBEN FÜR DACHBALKEN - VIS POUR PANNE DE TOIT			16	5x120	
	SCREW FOR GABLE - SCHRAUBEN FÜR GIEBEL - VIS POUR FIXATION DES PIGNONS			24	5x120	
	SCREW FOR 1. WALL BEAM - SCHRAUBE FÜR 1. BOHLENREIHE - VIS DE FIXATION DES FONDATIONS			10	5x90	
	SCREW FOR FUNDAMENT - SCHRAUBEN ZUR BEFESTIGUNG FUNDAMENT - VIS POUR FONDATION			14	5x120	
	SCREW FOR DOOR JAMB - SCHRAUBE FÜR TÜRRAHMEN - VIS DE FIXATION POUR MONTANT DE PORTE			4	5x90	
	ZN NAIL FOR FLOOR FILLET - ZN NÄGEL FÜR FUSSBODENLEISTE - POINTE POUR CORNIERE DE FINITION DU PLANCHER			50	1.4x40	
	HAMMER BLOCK - SCHLAGHOLZ - CALLE DE FRAPPE			1		
	SCREW FOR DOORSTEP - SCHRAUBEN FÜR TÜRSWELLE - VIS DE FIXATION DU SEUIL DE PORTE			5	4.5x65	
	ZN NAIL FOR ROOFING FELT FILLET - ZN NÄGEL FÜR DACHPAPPENLEISTE - POINTE POUR BAGUETTE FIXATION FEUTRE BITUMEUX			28	2x40	
	BOLT FOR WINDOW HANDLE FITTINGS - BOLZEN FÜR FENSTERGRIFF BESCHLAG - BOULON POUR POIGNÉE D'OUVERTURE DE FENETRE			4		
	GABLE SEGMENT-DECKBLATT - LOSANGE DE FINITION			2		
	NUT FOR STORM PROTECTION - SCHRAUBENMUTTER FÜR STURMLEISTE - ÉCROU POUR LAME ANTI-TEMPETE			8		
	BOLT FOR STORM PROTECTION - BOLZEN FÜR STURMLEISTE - VIS POUR LAME ANTI-TEMPETE			8		

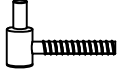
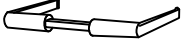
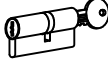
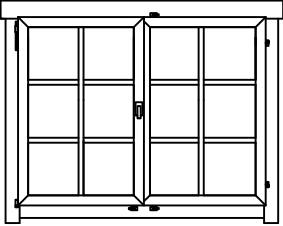
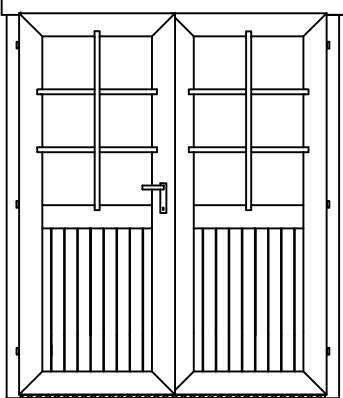
Pos	1.10.2012	ART.NR. 406200	8/8	Q.	P (mm)	L (mm)
	WASHER FOR STORM PROTECTION - DICHTSCHEIBE FÜR STURMLEISTE - RONDELLE POUR LAME ANTI-TEMPETE			8		
	ZN NAIL FOR ROOF - ZN NÄGEL FÜR DACHBRETTER - POINTE POUR TOIT			444	2x50	
	ZN NAIL FOR FLOOR - ZN NÄGEL FÜR FUSSBODENBRETTER - CLOUS POUR PLANCHER			392	2x50	
	SET OF DOOR LOCK COVERS - SCHLOSSBLENDEN - SET DE GARNITURES DE SERRURE DE PORTE			2		
	MALE BOLT HINGE FOR DOOR - TÜRRIEGEL - PARTIE MALE DE CHARNIERE DE PORTE			6		
	DOOR HANDLE FITTINGS-TÜRGRIF - SET DE GARNITURES DE SERRURE DE PORTE			2		
	CYLINDER LOCK - ZYLINDERSCHLOSS - CYLINDRE DE SERRURE			2		
	WINDOW-FENSTER-FENETRE 1290x990		TAK.1.106.SSV.b	2		
						
	DOOR-TÜR-PORTE 1494x1957		TUK.2.056.SVV.MMb	1		
						
	DOOR-TÜR-PORTE 835x1957		UL.2.100.IVV.MM	1		
	