

Art. Nr. 2825150

1/6

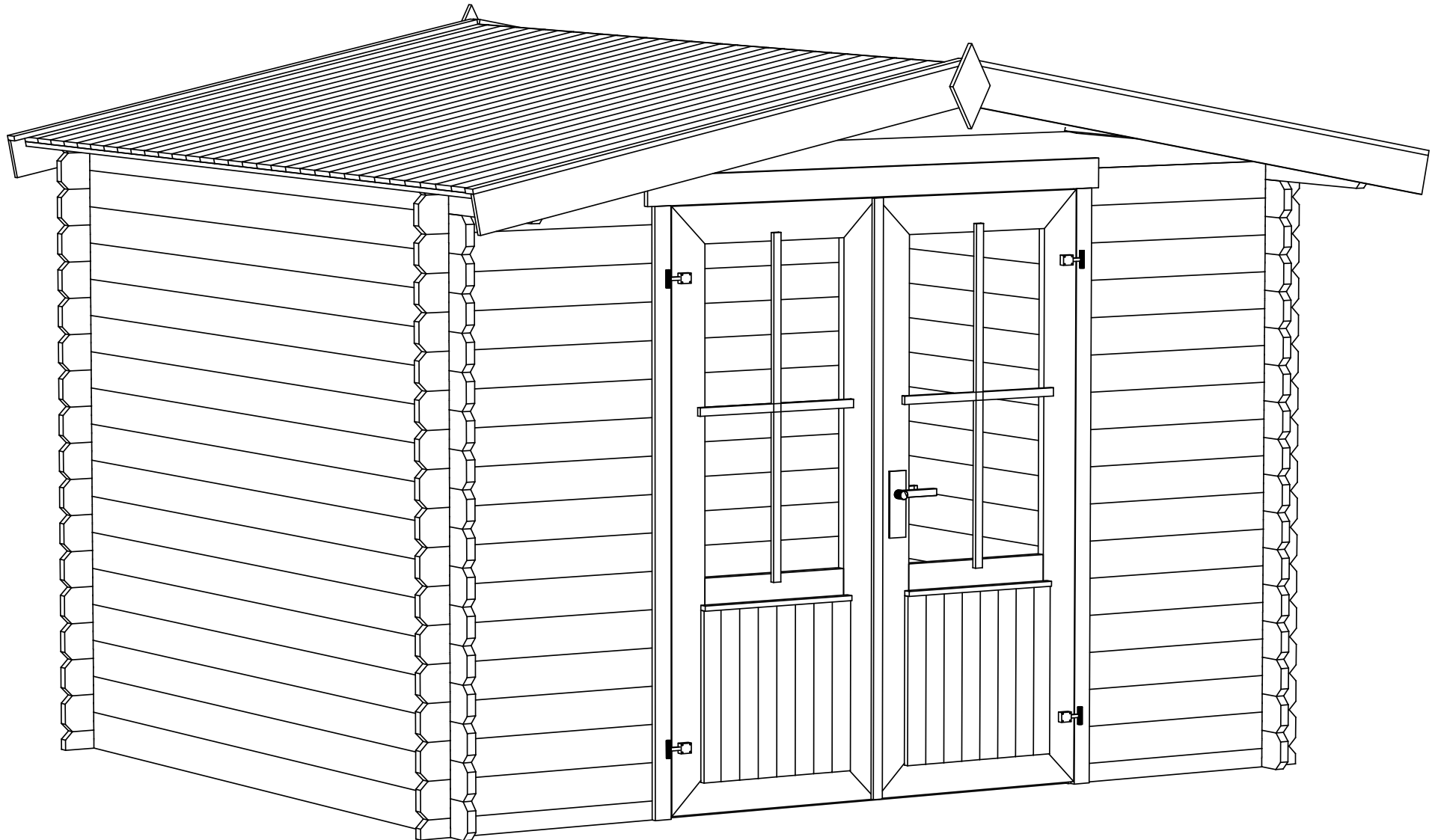

10.06.2015

Art. Nr. 2825150

GROUNDPLAN - GRUNDPLAN - PLAN DE MASSE

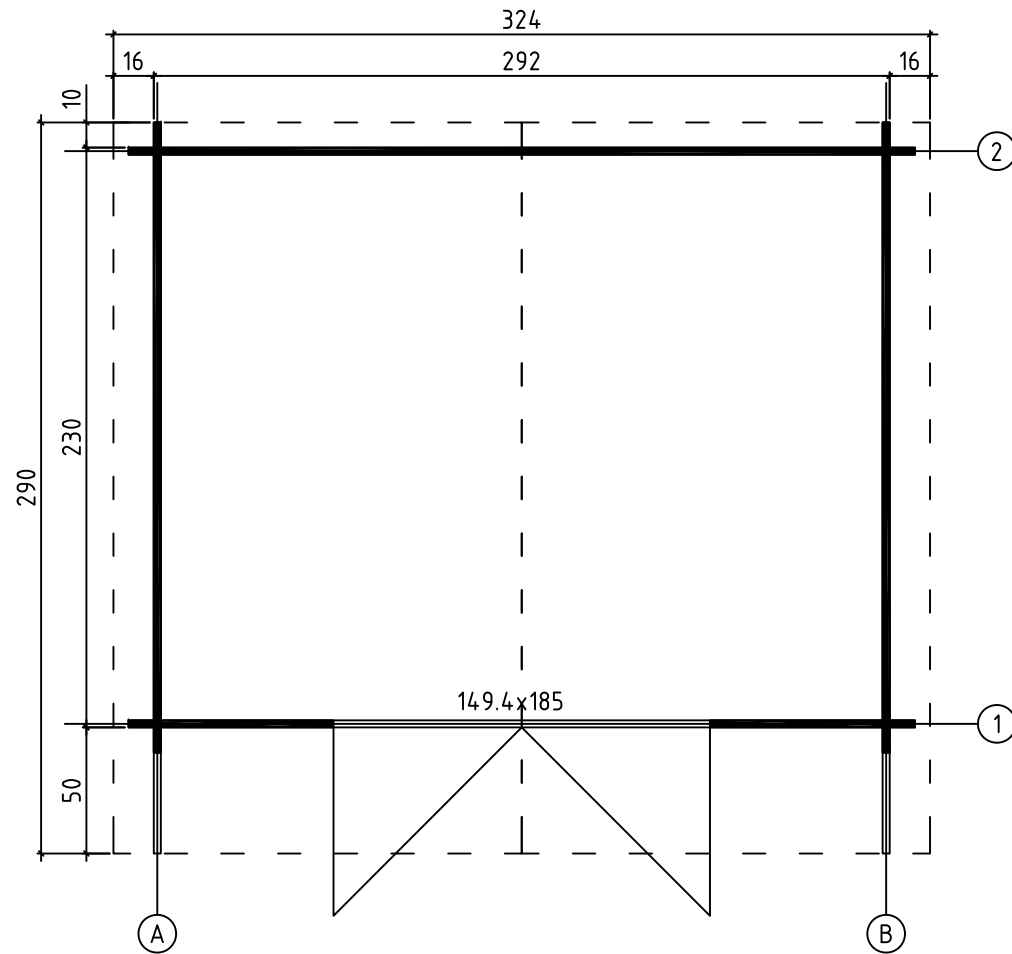



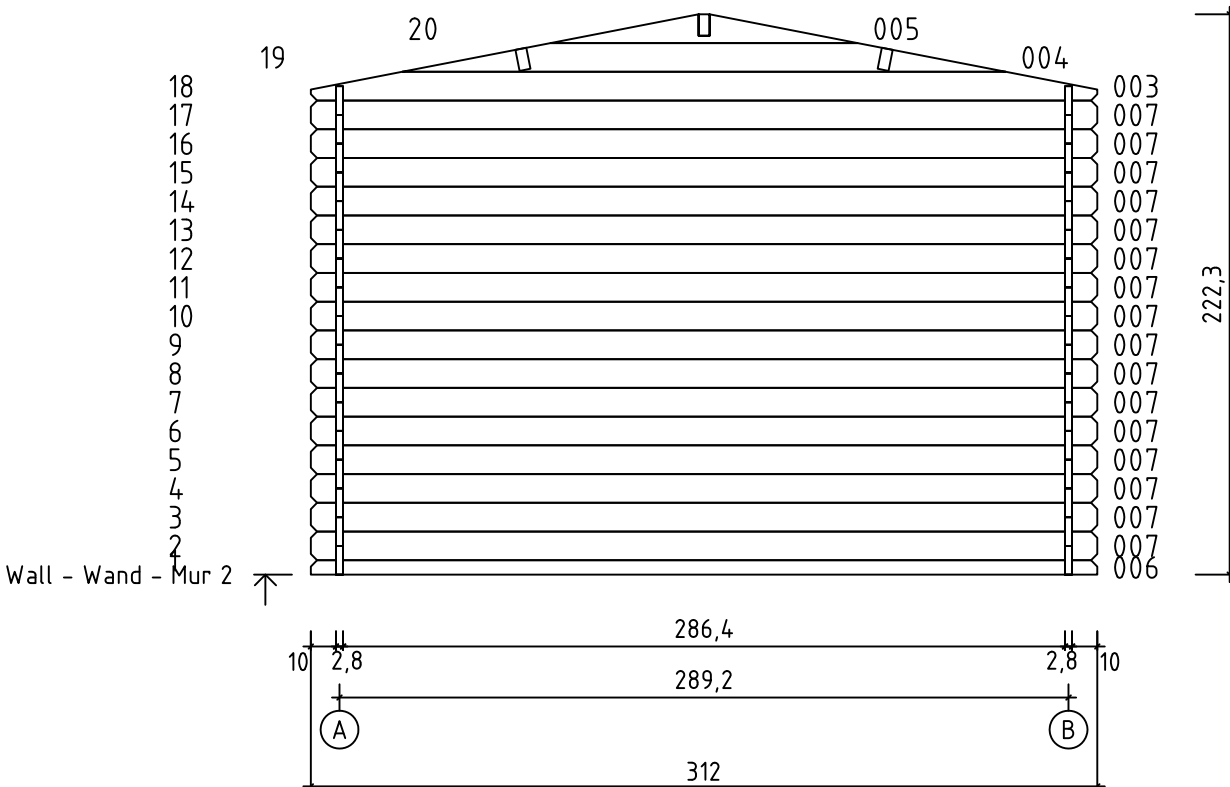
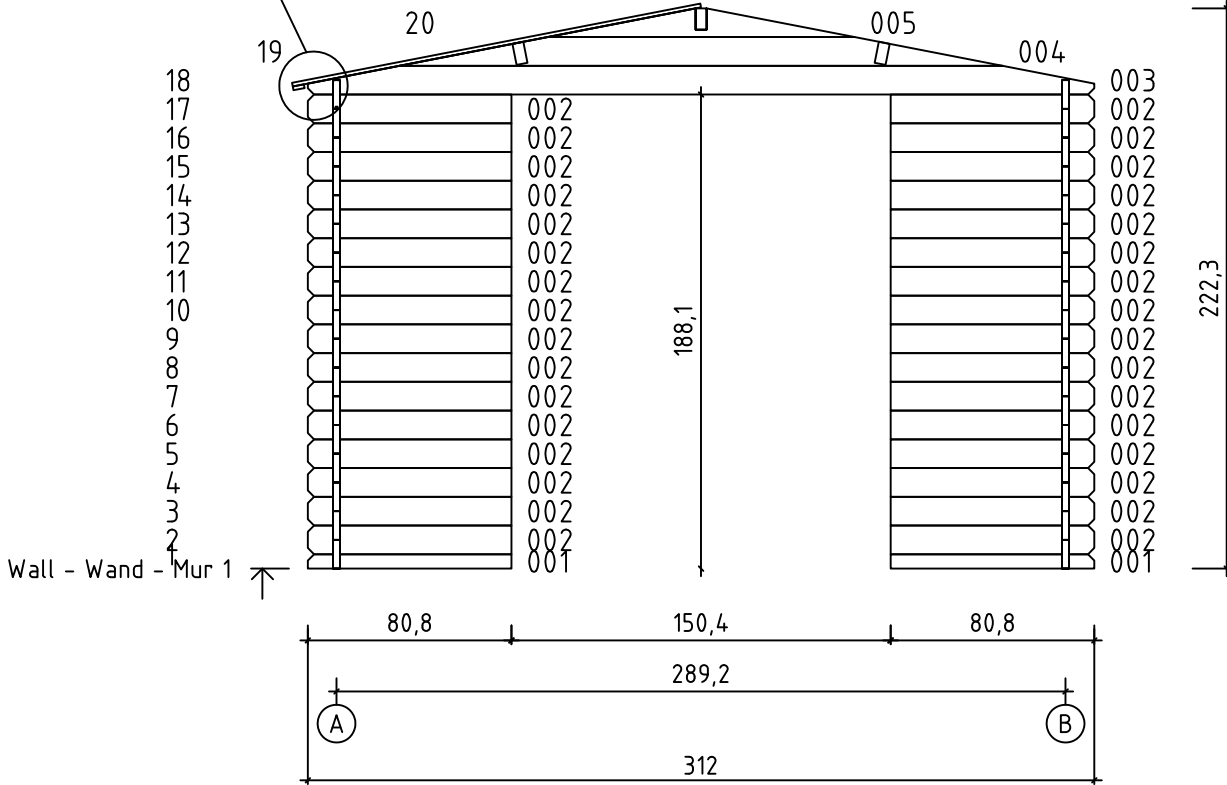
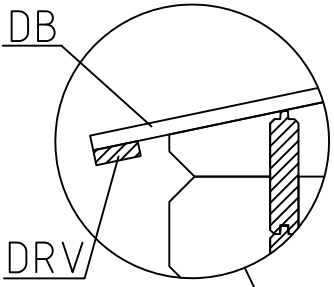



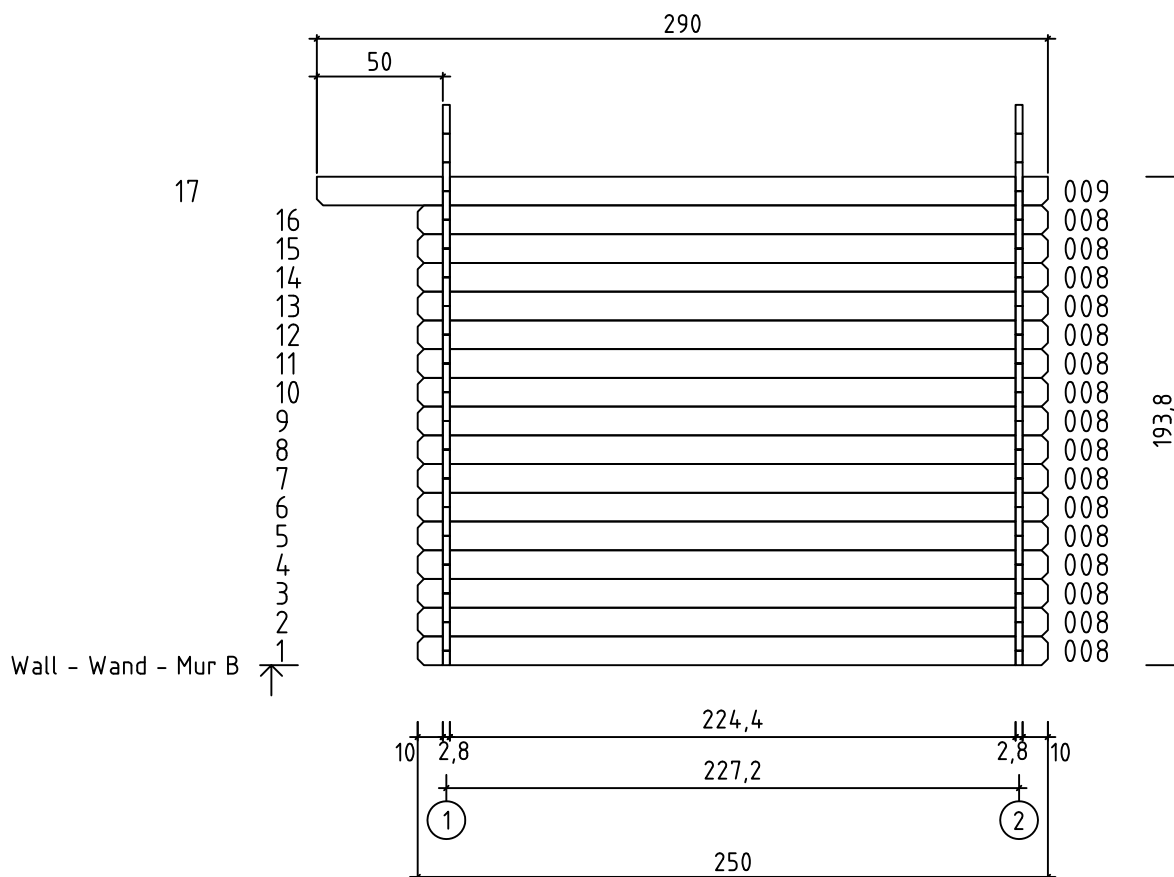
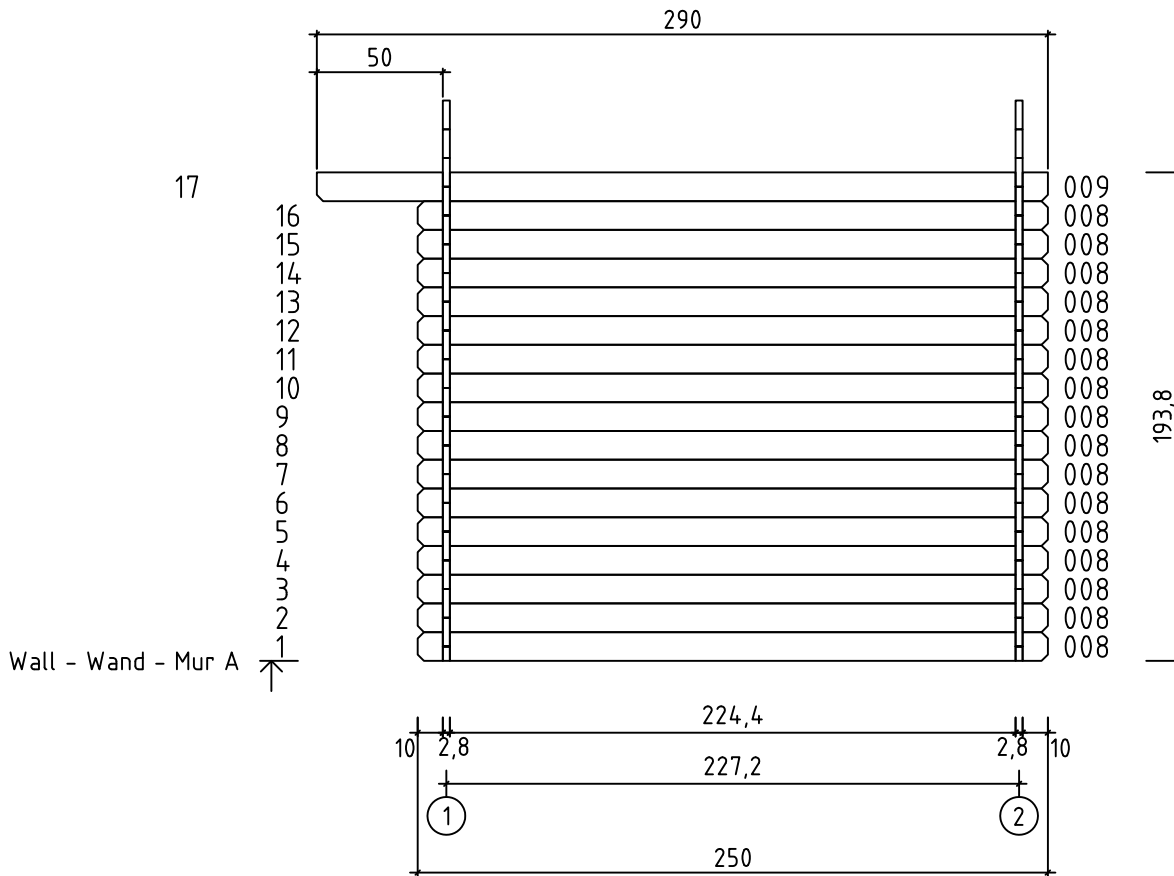

Art. Nr. 2825150

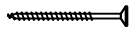

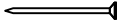
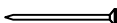

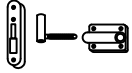
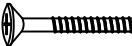
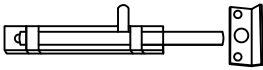

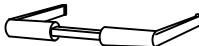
Art. Nr. 2825150

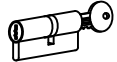
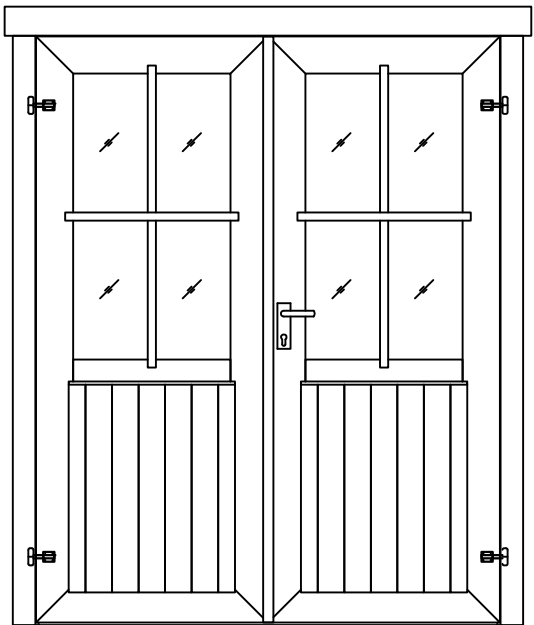

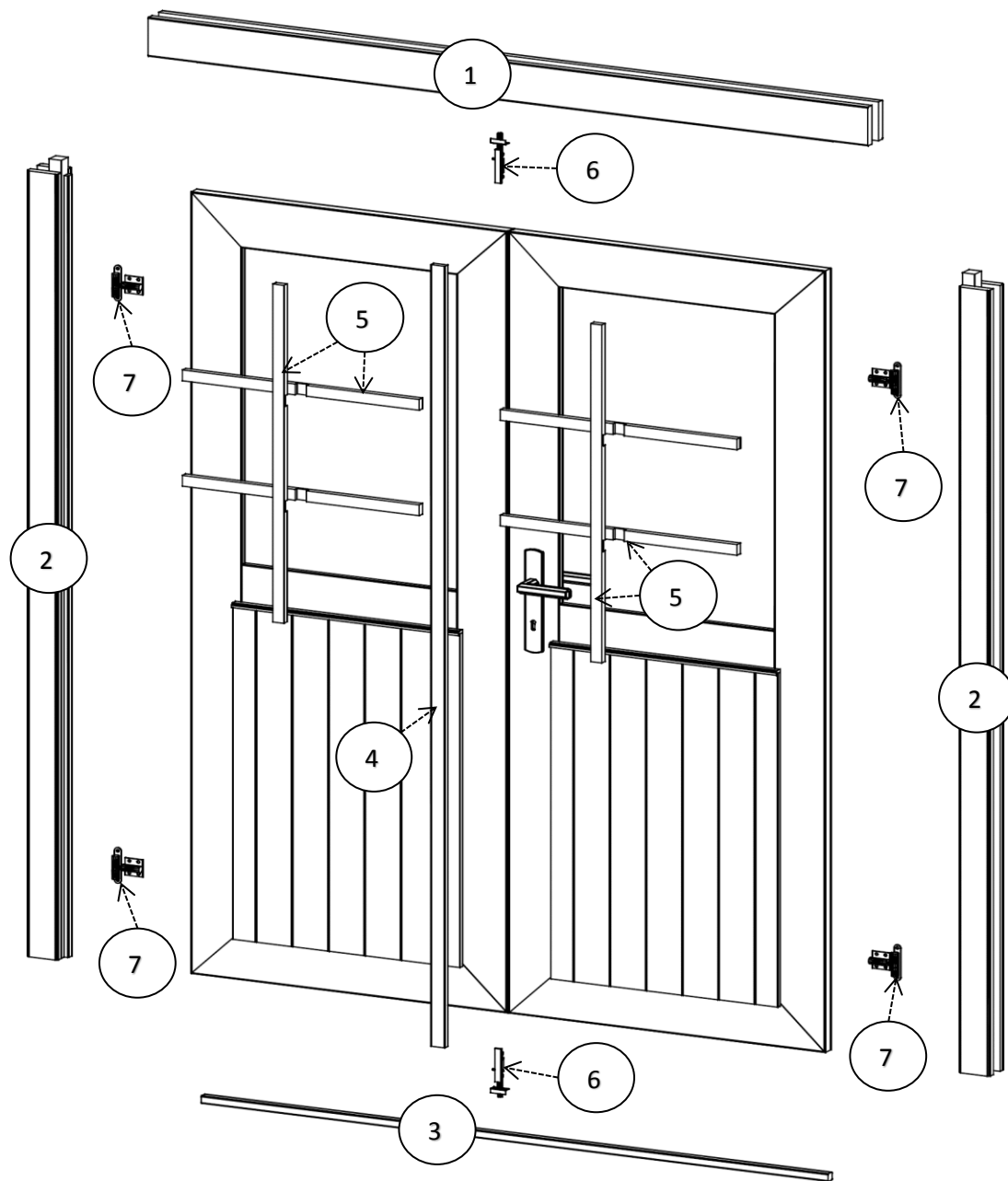
Pos	10.06.2015	Piecelist - Stücklist - Liste des composants Art. Nr. 2825150	5/6	Q.	P (mm)	L (mm)
001				2	28x57	808
002				32	28x114	808
006				1	28x57	3120
007				16	28x114	3120
008				32	28x114	2500
009				2	28x114	2900
W1-1 W2-1				1 1		
A-PR1		ROOF BEAM - DACHBALKEN - PANNE DE TOIT		3	44x95	2900
DB	ROOF BOARDS - DACHBRETTER - VOLIGES			66	90x15	1650
	ROOFING FELT FILLET - DACHPAPPENLEISTE - BAGUETTE DE FIXATION DU FEUTRE BITUMEUX			4	15x45	1700
DRV	ROOF EDGE REINFORCEMENT - DACHRANDVERSTÄRKUNG - CORNIERE DE RENFORT DE BORD DE TOIT			2	15x45	2900
KFS	STORM PROTECTION - STURMLEISTE - - LATTE ANTI-TEMPETE			4	22x45	1880
	ROOFING FELT (STRIP) - DACHPAPPE (BAHNEN) - - FEUTRE BITUMEUX (BANDE)			4		3000
	GABLE MOULDING - GIEBELLEISTE - - PLANCHE DE RIVE			4	15x120	1700
	SCREW FOR GEORGIAN BARS - SCHRAUBE FÜR SPROSSEN - VIS POUR CROISSILLONS DE PORTE			8	2.5x20	
HS12	SCREW FOR GABLE SEGMENT - SCHRAUBEN FÜR DECKBLATT - VIS POUR FIXATION LOSANGE DE FINITION			4	3.5x35	
HS22	SCREW FOR FIXING DOOR TO THE WALL - SCHRAUBE ZUR BEFESTIGUNG TÜR - ZARGE MIT WAND - VIS POUR FIXATION DORMANT DE PORTE AU 1ER RANG DE MADRIER			2	3.5x50	
HS16	SCREW FOR GABLE MOULDING - SCHRAUBEN FÜR GIEBELLEISTE - VIS POUR FIXATION PLANCHE DE RIVE			24	3.5x50	
HS59	SCREW FOR DOORSTEP - SCHRAUBEN FÜR SWELLE - VIS POUR FIXATION BARRE DE SEUIL			3	3x30	
	SCREW FOR ROOF EDGE REINFORCEMENT - SCHRAUBEN FÜR DACHRANDVERSTÄRKUNG - VIS POUR RENFORT DE BORD DE TOIT			14	3x30	
HS3	SCREW FOR DOOR FILLET - SCHRAUBE ZUR BEFESTIGUNG TÜRLEISTE - VIS POUR FIXATION BAGUETTE D'ARRET DE PORTE			5	3x30	
HS56	SCREW FOR FIXING BOLT HINGE - SCHRAUBE FÜR TÜRRIESEL - VIS POUR FIXATION GONDS DE PORTE - POUR OUVRANT			16	4x30	
HS58	SCREW FOR FIXING BOLT HINGE - SCHRAUBE FÜR TÜRRIESEL - VIS POUR FIXATION GONDS DE PORTE - POUR OUVRANT			12	4x40	
HS41	SCREW FOR DOOR JAMB - SCHRAUBE FÜR TÜRRAHMEN - VIS POUR FIXATION MONTANT DE PORTE			2	4x60	

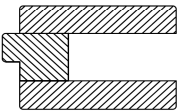
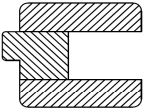
Pos	10.06.2015	Piecelist - Stücklist - Liste des composants Art. Nr. 2825150	6/6	Q.	P (mm)	L (mm)
HS43		SCREW FOR ROOF BEAMS - SCHRAUBEN FÜR DACHBALKEN - VIS POUR FIXATION PANNES DE TOIT		10	5x120	
HS41		SCREW FOR DOOR JAMB - SCHRAUBE FÜR TÜRRAHMEN - VIS POUR FIXATION MONTANT DE PORTE		2	5x90	
SH28		HAMMER BLOCK - SCHLAGHOLZ - CALLE DE FRAPPE		1		
SFS		NUT FOR STORM PROTECTION - SCHRAUBENMUTTER FÜR STURMLEISTE - ECROU POUR LATTE ANTI-TEMPETE		8	D6	
NF2		ZN NAIL FOR ROOF - ZN NÄGEL FÜR DACHBRETT - POINTE POUR FIXATION VOLIGES DE TOIT		212	2x50	
NFD		ZN NAIL FOR ROOFING FELT FILLET - ZN NÄGEL FÜR DACHPAPPENLEISTE - POINTE POUR BAGUETTE DE FIXATION FEUTRE BITUMEUX		16	2x40	
NF		ROOFING NAILS FOR ROOFING FELT - NÄGEL FÜR DACHPAPPE - POINTE POUR FIXATION FEUTRE BITUMEUX		105	2.8x15	
		MALE BOLT HINGE FOR DOOR - TÜRRIEGEL - PARTIE MALE DE PAUMELLE DE PORTE		4		
BFS		BOLT FOR STORM PROTECTION - BOLZEN FÜR STURMLEISTE - BOULON POUR LATTE ANTI-TEMPETE		8	6x60	
TL		LATCH BOLT FOR DOUBLE DOOR - TORRIEGEL - LOQUET POUR DOUBLE PORTE		2		90
GS		GABLE SEGMENT - DECKBLATT - LOSANGE DE FINITION		2		
DFS		WASHER FOR STORM PROTECTION - DICHTSCHEIBE FÜR STURMLEISTE - RONDELLE POUR LATTE ANTI-TEMPETE		8	D6	
TL4		DOOR HANDLE FITTINGS - TÜRGRIF - POIGNEE DE PORTE		1		
TL5		SET OF DOOR LOCK COVERS - SCHLOSSBLENDEN - SET DE GARNITURES DE PORTE		1		
		CYLINDER LOCK - ZYLINDERSCHLOSS - BARILLET DE PORTE		1	30/30	
		DOOR - TÜR - PORTE 1494x1850 XGA+28 TUK.2.044.XVP.MX28 Plexiglass - Plexiglas - Plexiglas		1		

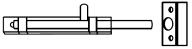
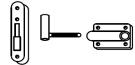

Pos	Piece list - Stückliste - Liste des pièces	Q.	P (mm)
1		1	66x100
2		2	66x80
3		1	18x18
4		1	13x32
5		6	15x25
6		2	
7		4	

