

Panama
Art. Nr. 443093
1/9

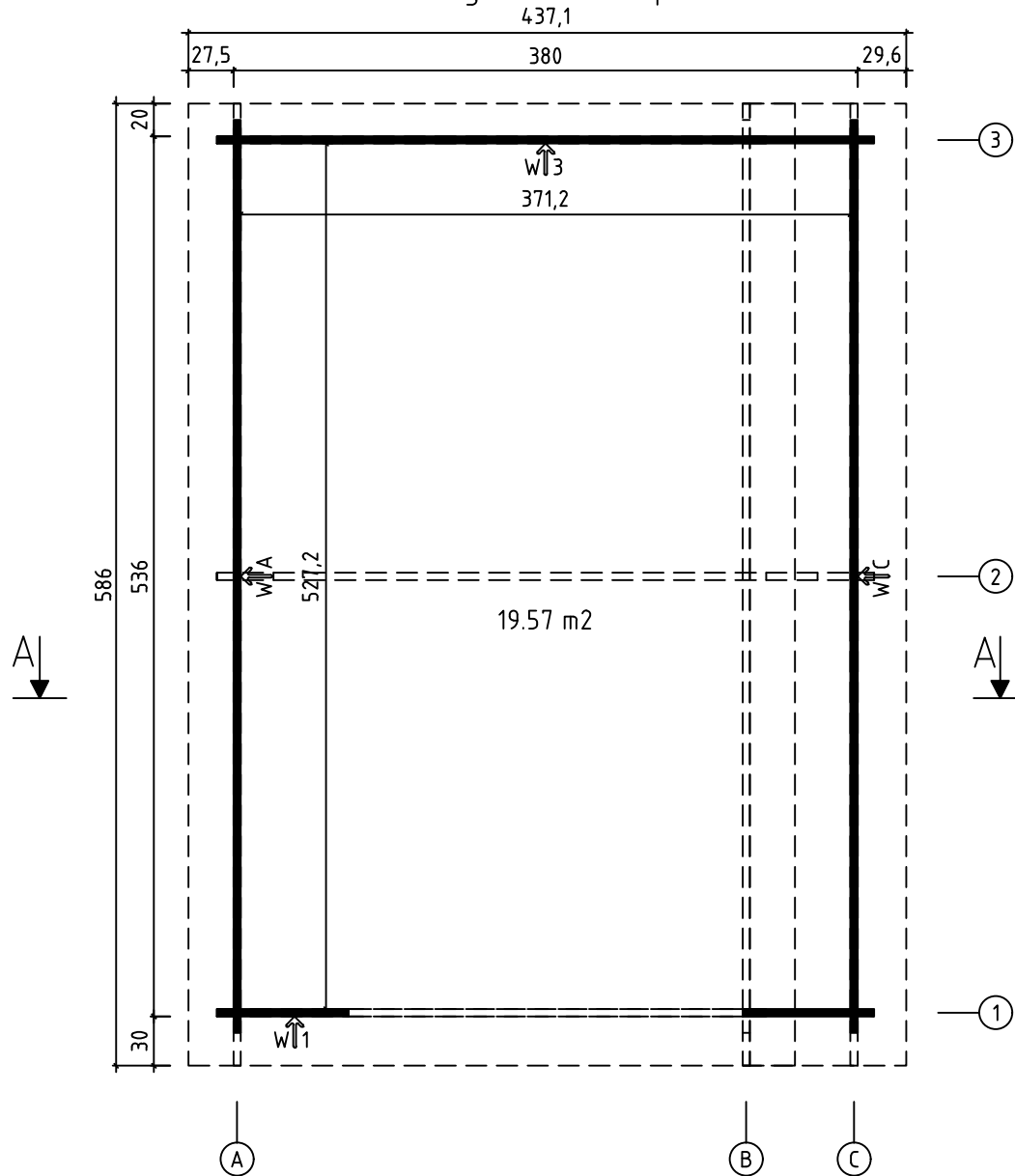

8.08.2018

Grundplan - Grundplan - Plan de masse - Planimetria -
Plattegrond - Põhiplaan



Foundation - Fundament - Fondation - Fundamenta -
Fundering - Immutatud alusraam

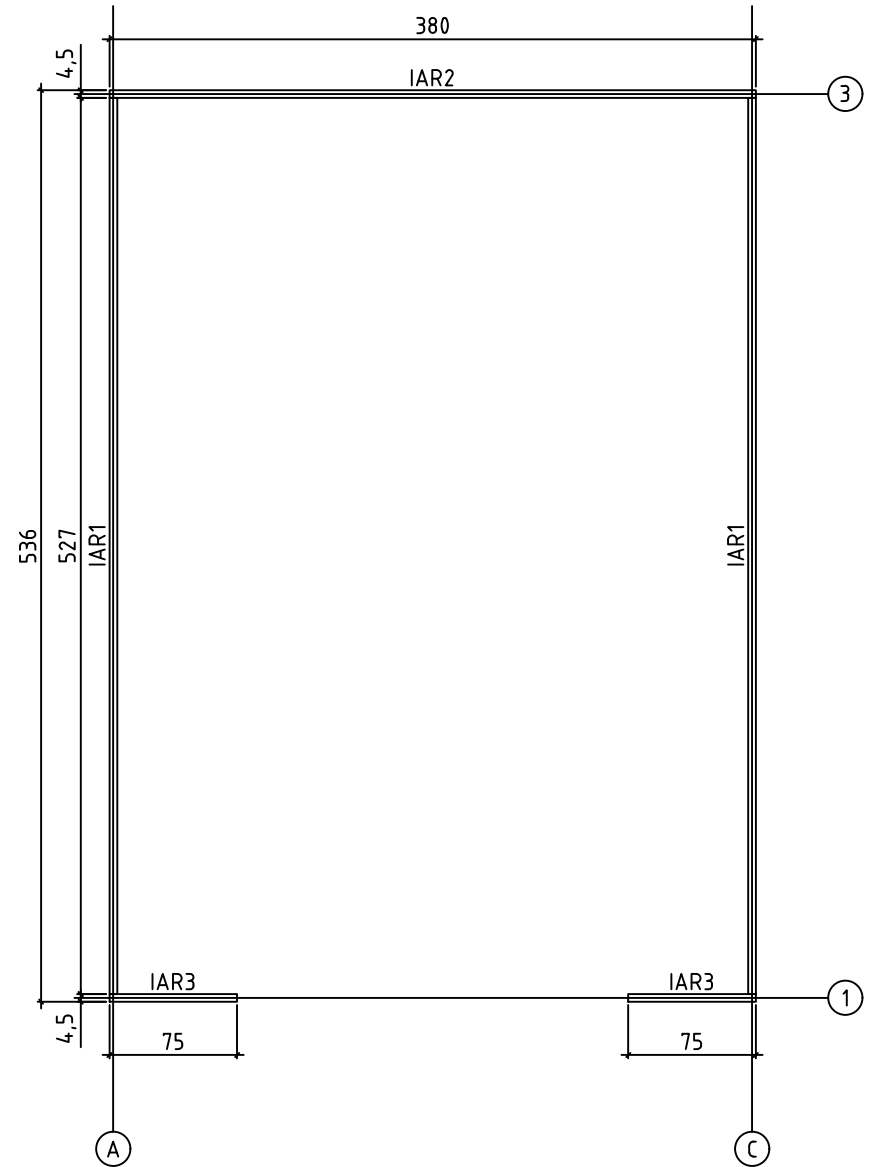

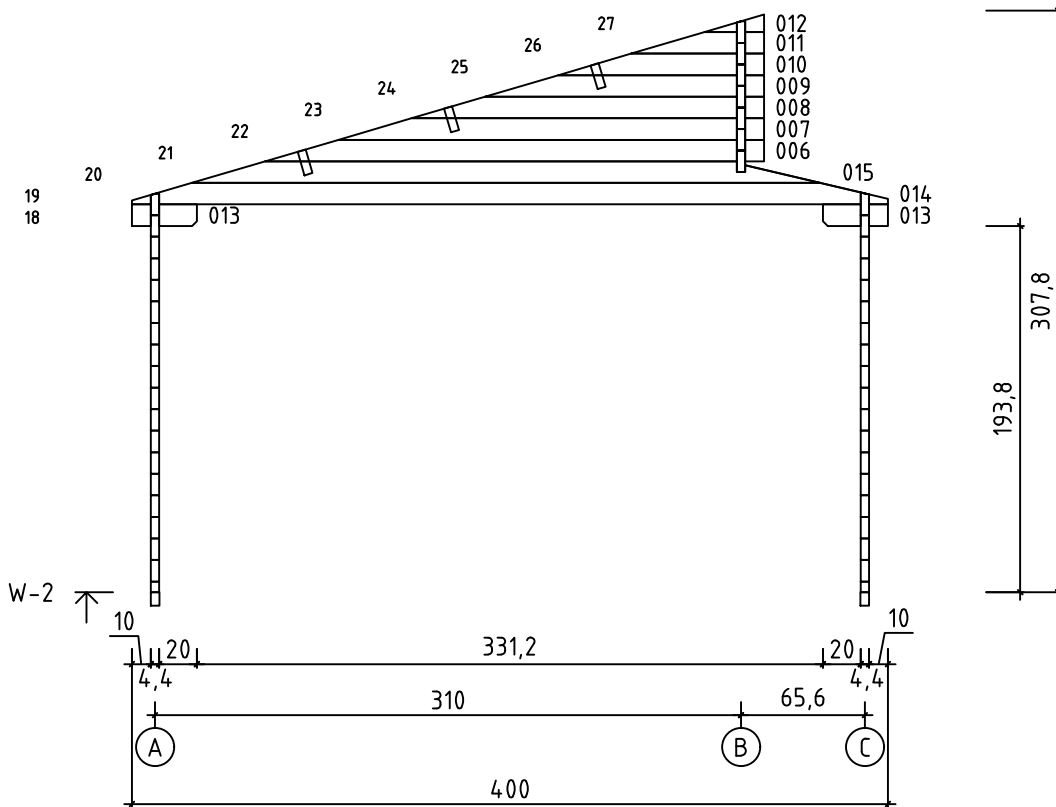
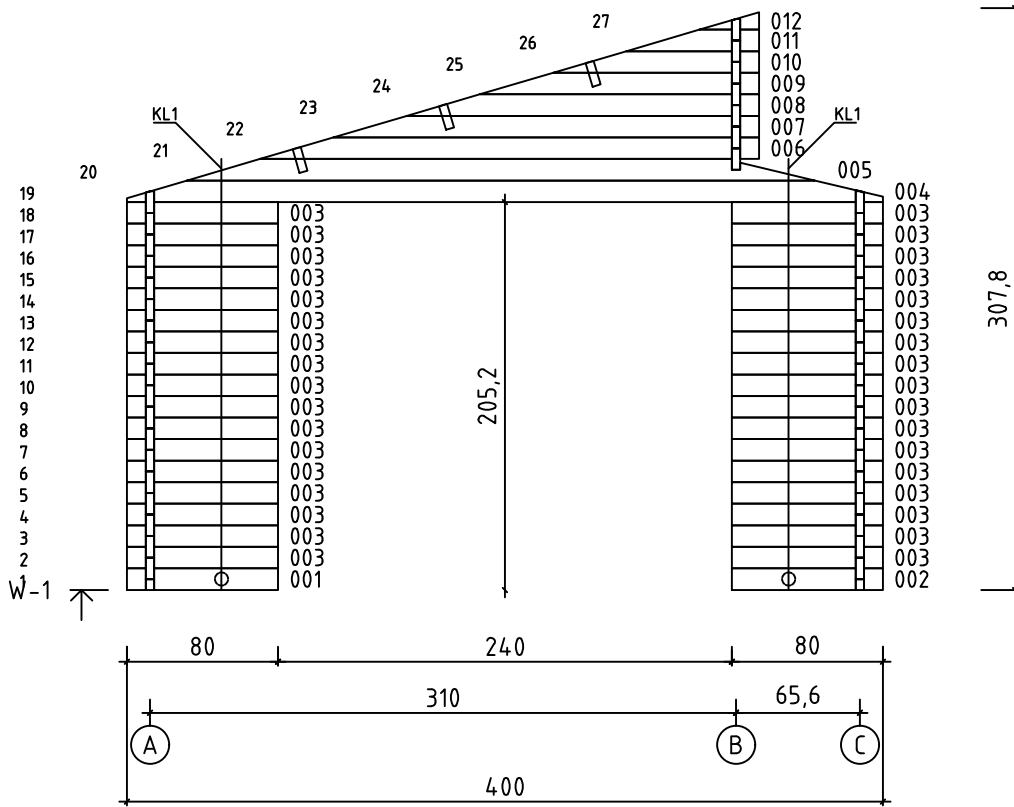

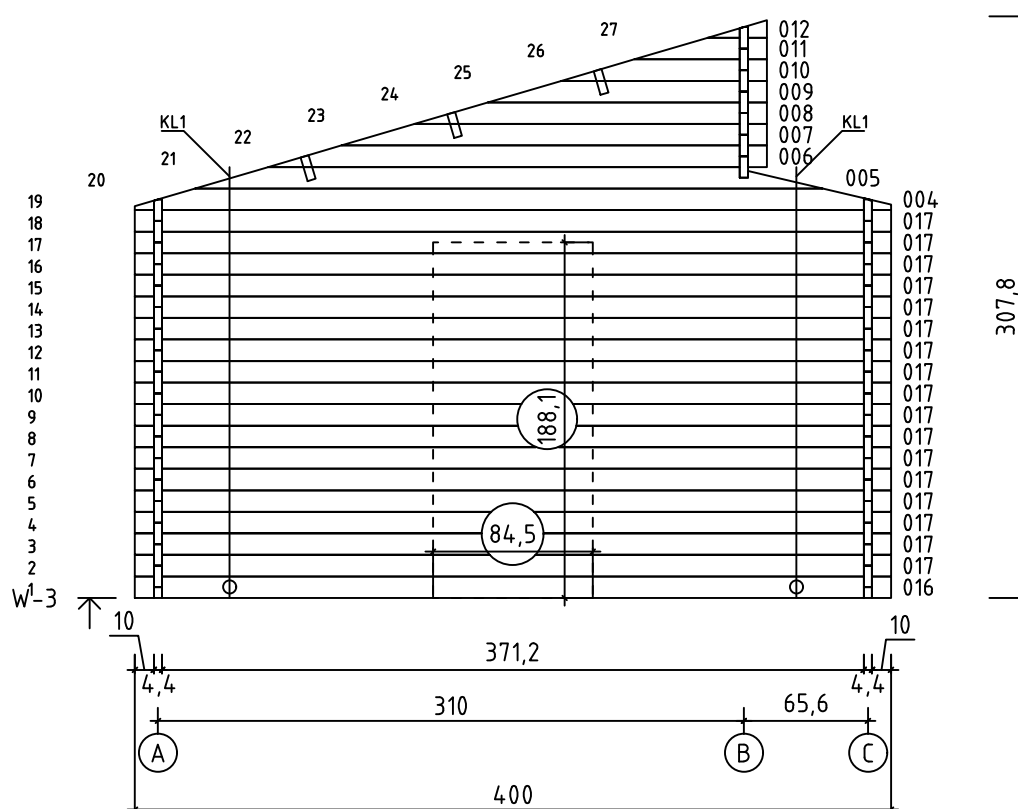

A single door (83.5x185 cm) has been delivered together with the building. You can choose the location for the door by yourself by cutting the wall logs as shown in the picture (see the dotted line).

Eine Einzeltür (83.5 x 185 cm) ist im Lieferumfang enthalten. Über die Positionierung der Tür entscheiden Sie selbst, indem Sie den Ausschnitt für die Tür in Eigenregie einschneiden (siehe Bild unter der gestrichelten Linie).

Une porte simple (83.5x185 cm) est livree avec l'abri. Vous pouvez choisir l'endroit ou vous voulez monter la porte en decoupant les madriers tel qu'illustre dans le schema (voir ligne en pointilles).

Una porta singola (83.5x185 cm) é stata consegnata con la casa. Tu puoi scegliere la posizione della porta secondo il tuo gradimento. tagliando la parete come raffigurato nella fotografia (segui la linea tratteggiata).

Bij uw huisje is een losse enkele deur (83.5x185 cm) geleverd. U heeft hierin een vrije keuze waar u deze wilt inbouwen, door het inzagen van de wandbalk zoals op de tekening (zie de stippellijn).

Majakomplekt sisaldab üksikut (83.5x185 cm), mille asukoht on võimalik ise valida. Ukseava tuleb lõigata joonisel näidatud mõõtudes (vaadake punktiirjooni).

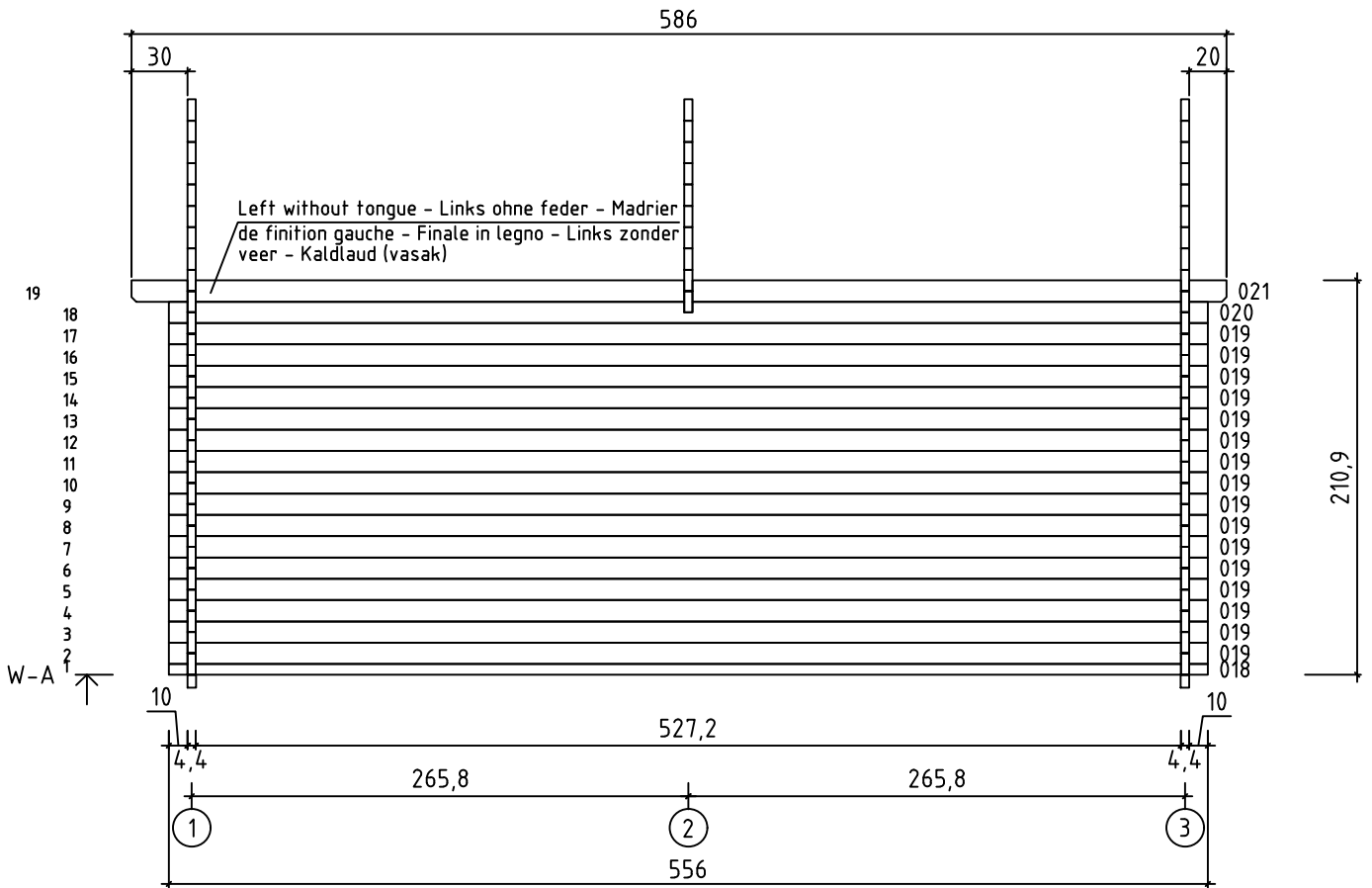
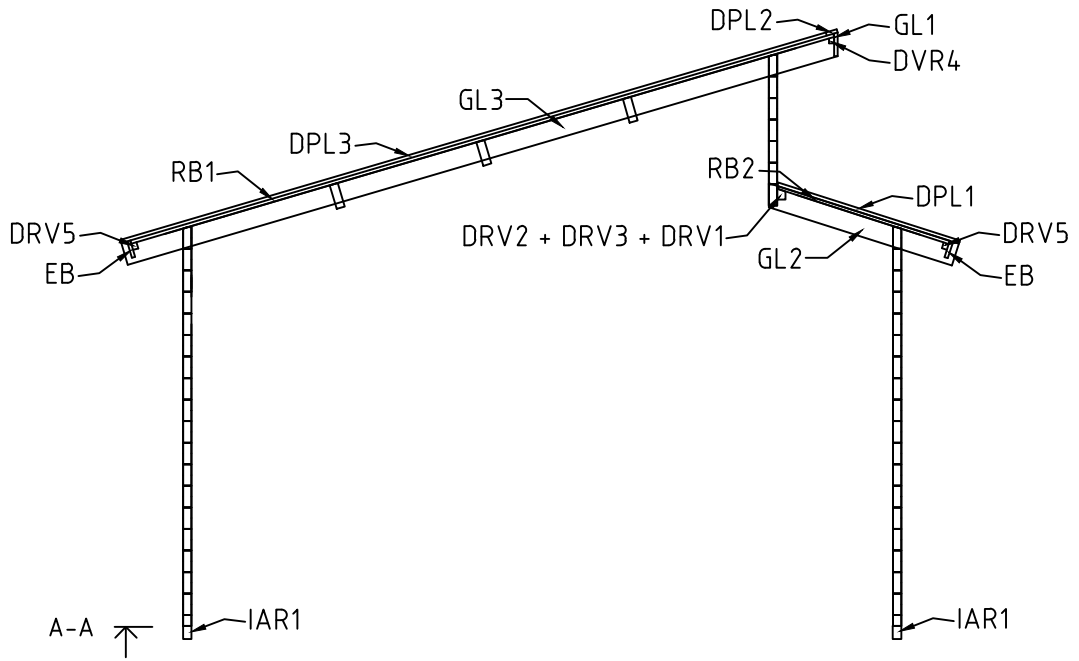



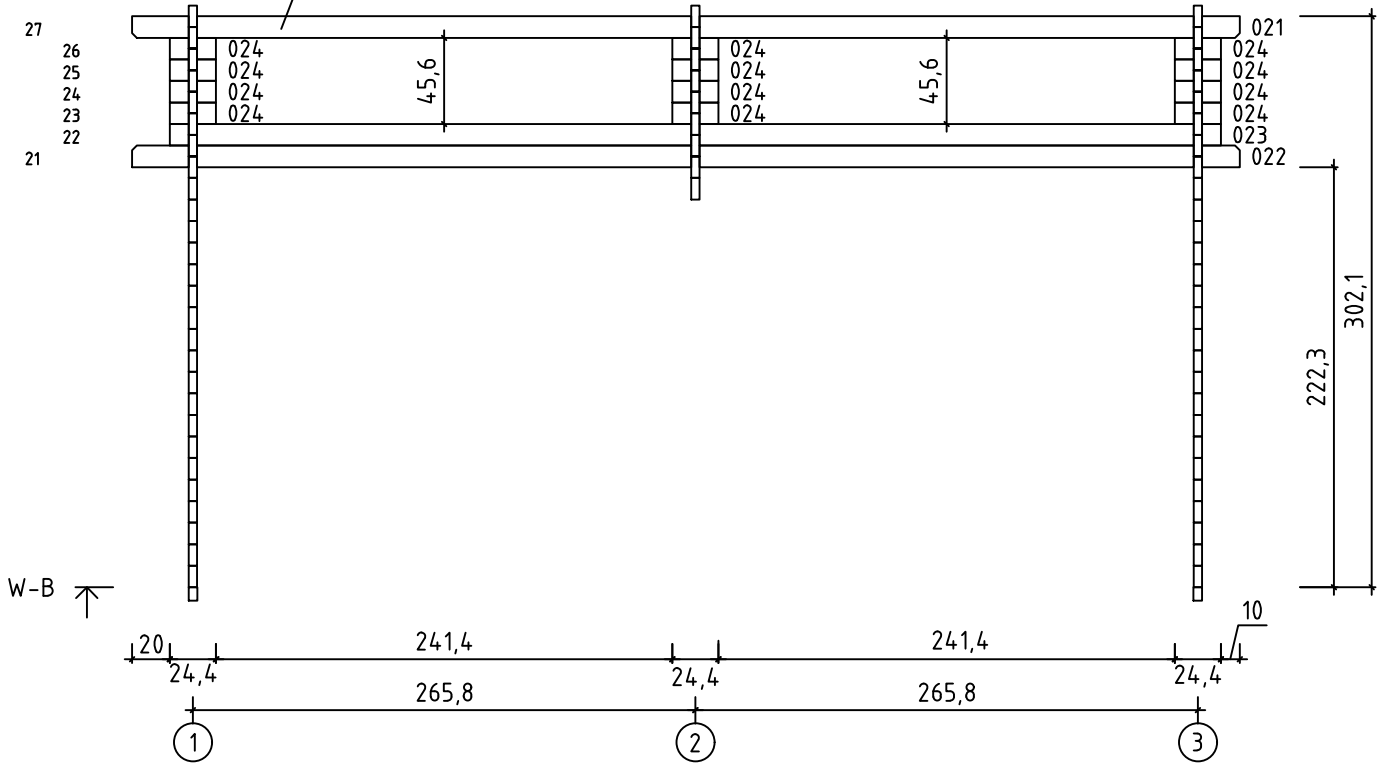

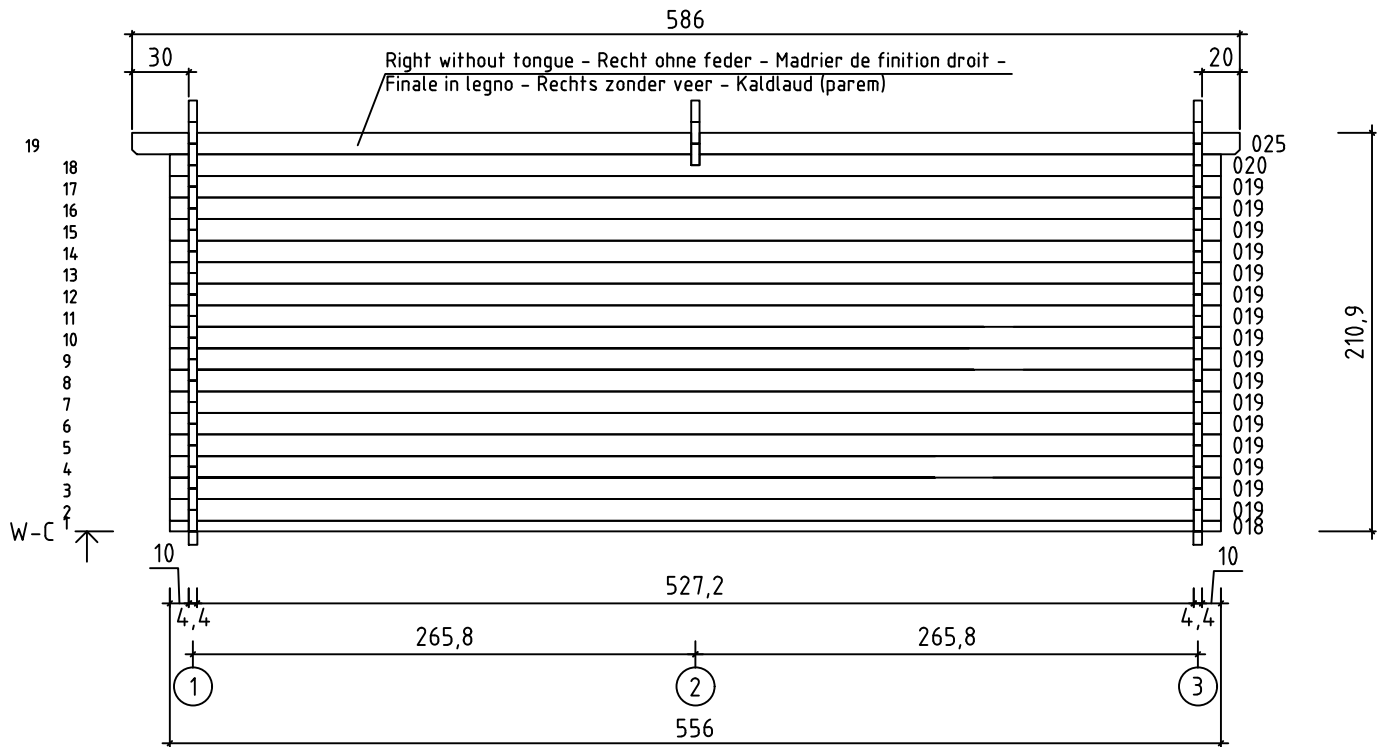

Left without tongue - Links ohne feder - Madrier de finition gauche - Finale in legno -
 Links zonder veer - Kaldlaud (vasak)

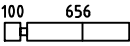
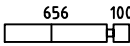
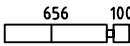

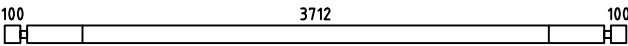
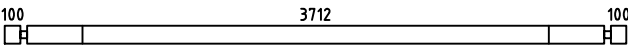
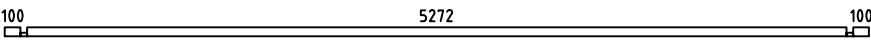
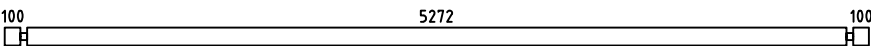
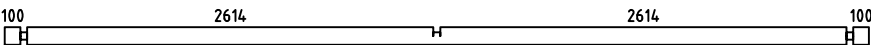
Right without tongue - Recht ohne feder - Madrier de finition droit -
 Finale in legno - Rechts zonder veer - Kaldlaud (parem)

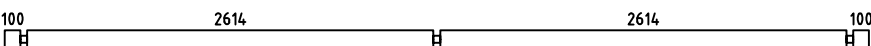

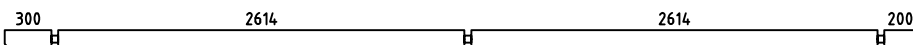
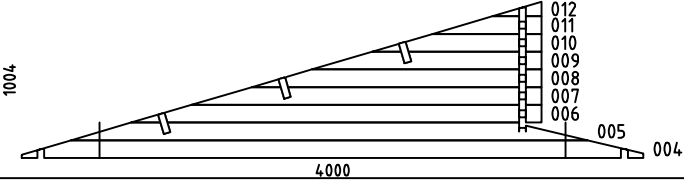
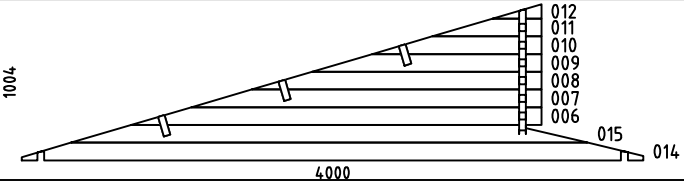
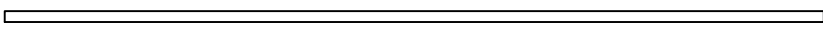
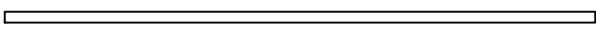
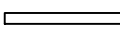
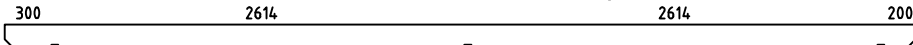
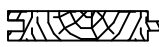

Pos	08.08.2018 Piece list - Stückliste - Liste des pièces - Elementi - Stuklijst - Tükítabel Art. Nr. 443093	7/9	Q	P (mm)	L (mm)
001			1	44x114	800
002			1	44x114	800
003			34	44x114	800
013			2	44x114	344
016			1	44x114	4000
017			17	44x114	4000
018			2	44x57	5560
019			32	44x114	5560
020			2	44x114	5560
021			2	44x120	5860
022			1	44x114	5860
023			1	44x114	5560
024			12	44x114	244
025			1	44x120	5860
W1-1 W3-1			1 1		
W2-1			1		
IAR1	Foundation - Fundament - Fondation - Fondamenta - Fundering - Immutatud alusraam 		2	45x70	5270
IAR2	Foundation - Fundament - Fondation - Fondamenta - Fundering - Immutatud alusraam 		1	45x70	3800
IAR3	Foundation - Fundament - Fondation - Fondamenta - Fundering - Immutatud alusraam 		2	45x70	750
APR1	Roof beam - Dachbalken - Panne de toit - Perlina del tetto - Gordingen / dakbalk - Pärilin 		3	44x140	5860
RB1	Roof boards - Dachbretter - Voliges - Perlina per tetto - Dakhout - Katuselaud 		66	90x18	3850

Pos	08.08.2018 Piece list - Stückliste - Liste des pièces - Elementi - Stuklijst - Tükitalabel Art. Nr. 443093 8/9	Q	P (mm)	L (mm)
RB2	Roof boards - Dachbretter - Voliges - Perlina per tetto - Dakhout - Katuselaud 	66	90x18	1000
DRV1	Wall finishing board - Abschlussbohle - Madrier supérieur de finition - Assi di finitura della parete - Wand afdekplaat - Kald-poollaud 	1	44x57	200
DRV2	Wall finishing board - Abschlussbohle - Madrier supérieur de finition - Assi di finitura della parete - Wand afdekplaat - Kald-poollaud 	1	44x57	300
DRV3	Wall finishing board - Abschlussbohle - Madrier supérieur de finition - Assi di finitura della parete - Wand afdekplaat - Kald-poollaud 	2	44x57	2612
DRV4	Roof edge reinforcement - Dachrandverstärkung - Corniere de renfort de bord de toit - Rinforzo x tetto - Dakrand versterking - Kald-räästatugevdus 	2	28x34	2930
GL1	Gable moulding - Giebelleiste - Planche de rive - Finitura per frontale e retro del tetto - Gevellijst - Kald-viilulaud 	2	18x120	2930
DPL1	Roofing felt fillet - Dachpappenleiste - Baguette de fixation du feutre bitumeux - Asse per fissaggio guaina bituminosa - Afdeklijst asfaltpapier - Katusepapiilist 	2	18x58	1008
DPL2	Roofing felt fillet - Dachpappenleiste - Baguette de fixation du feutre bitumeux - Asse per fissaggio guaina bituminosa - Afdeklijst asfaltpapier - Katusepapiilist 	2	18x58	2890
DPL3	Roofing felt fillet - Dachpappenleiste - Baguette de fixation du feutre bitumeux - Asse per fissaggio guaina bituminosa - Afdeklijst asfaltpapier - Katusepapiilist 	2	18x58	3900
KL1	Treaded rod m10 - Gewindestange m10 - Tige filetée m10 - Barra filettata passo m10 - Draadstang 10m - Keermelatt 	4		170
KL1	Treaded rod m10 - Gewindestange m10 - Tige filetée m10 - passo m10 - Draadstang 10m - Keermelatt 	4		2000
EB	Fascia board - Traufbrett - Bandeau de toit - Finitura lati tetto - Gevellijst - Räästalaud 	4	18x90	2930
DRV5	Roof edge reinforcement - Dachrandverstärkung - Corniere de renfort de bord de toit - Rinforzo x tetto - Dakrand versterking - Räästatugevdus 	4	28x34	2930
	Support beam for gate frame - Stutzbohle für torzarge - Madrier de support du cadre de la porte basculante - Asse di supporto per il telaio della porta - Steunpaal voor poort-/ deurkozijn - Tugipuu 	1	44x140	3710
GL2	Gable moulding - Giebelleiste - Planche de rive - Finitura per frontale e retro del tetto - Gevellijst - Viilulaud 	2	18x120	1100
GL3	Gable moulding - Giebelleiste - Planche de rive - Finitura per frontale e retro del tetto - Gevellijst - Viilulaud 	2	18x120	3900
LD1	Lid for treaded rod hole - Abdeckung für gewindestangenöffnung - Couvercle pour acces réglagé tige filetée - Copeerchio per foro barra filettata - Afdekprofiel voor draadstang - Kaas keermelati avale 	4		
	Lengthening bolt for treaded rod - Verlängerungsmutter für gewindestange - Manchon de raccordement de tige filetée - Bullone per barra filettata passo - Extensie moer voor draadstang - Keermelati jätkumutter 	4	D10	
HS9	Screw for gable moulding - Schrauben für giebelleiste - Vis pour fixation planche de rive - Vite per fissare finiture davanti e dietro del tetto - Schroef voor gevellijst - Kruvi viilulauale 	44	3.5x50	
HS14	Screw for roof edge reinforcement - Schrauben für dachrandverstärkung - Vis pour fixation corniere renfort de bord de toit - Viti x rinforzo bordo tetto - Schroef voor dakrand versterking - Kruv kald-poollauale 	16	4.5x80	
HS12	Screw for fascia boards - Schrauben für traufbretter - Vis pour fixation bandeau de toit - Viti x striscia del tetto - Schroef voor gevellijst - Kruvi räästalauale 	28	4x40	
HS12	Screw for roof edge reinforcement - Schrauben für dachrandverstärkung - Vis pour fixation corniere renfort de bord de toit - Viti x rinforzo bordo tetto - Schroef voor dakrand versterking - Kruvi räästatugevdusele 	42	4x40	
HS18	Screw for gable - Schrauben für giebel - Vis pour fixation des pignons - Viti per timpano - Schroef voor gevelpunt - Kruvi kelba kinnitamiseks 	21	5x120	

Pos	27.11.2017	Piece list - Stückliste - Liste des pièces - Elementi - Stuklijst - Tükítabel 2400x410 TAK.1.100.TSM0 SGC	1/1	Q	P (mm)	L (mm)
-----	------------	--	-----	---	-----------	-----------

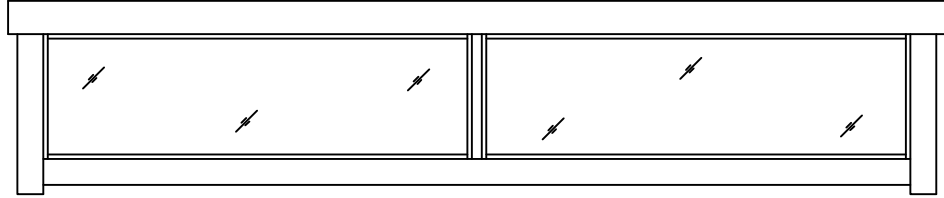
Glass size - Glasgröße - Taille de la vitre - Misura del vetro - Glas afmeting - Klaasi mõõt: 1145x330 mm

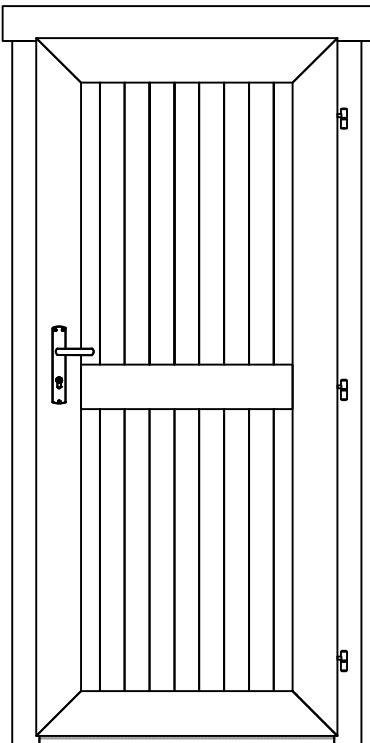
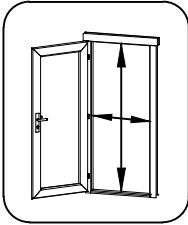
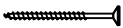
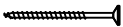

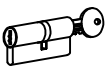
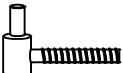
Pos	05.12.2017	Piece list - Stückliste - Liste des pièces - Elementi - Stuklijst - Tükitabel 835x1850 UL.2.100.IVP.MMa TC	1/1	Q	P (mm)	L (mm)
		  <p>735x1768 mm</p>				
HS25	Screw for doorstep - Schrauben für swelle - Vis pour fixation barre de seuil - Vite per soglia della porta - Schroef voor deurdorpel - Kruvi lävepakule		2	4.5x65		
HS16	Screw for door jamb - Schraube für türrahmen - Vis de fixation partie haute avec montants du cadre de porte - Viti x fissaggio montanti porte - Schroef voor deurkozijn - Kruvi ukse lengile		4	5x90		
TL4	Door handle fittings - Türgriff - Poignee de porte - Maniglie - Deurhendel / klink - Ukse käepide		1			
TL5	Set of door lock covers - Schlossblenden - Set de garnitures de porte - Copertura serrature - Slot sluitplaat set - Ukse lukuplaat		1			
	Cylinder lock - Zylinderschloss - Barillet de porte - Serratura - Cylinder slot - Ukse lukusüdamik		1	30x35		
	Male bolt hinge for door - Türband - Partie male de paumelle de porte - Cerniera anube x porta - Scharnier bout - Ukse polthing isane		3			