

*Barbados 2*  
*Art. Nr. 4414502*  
*1/8*

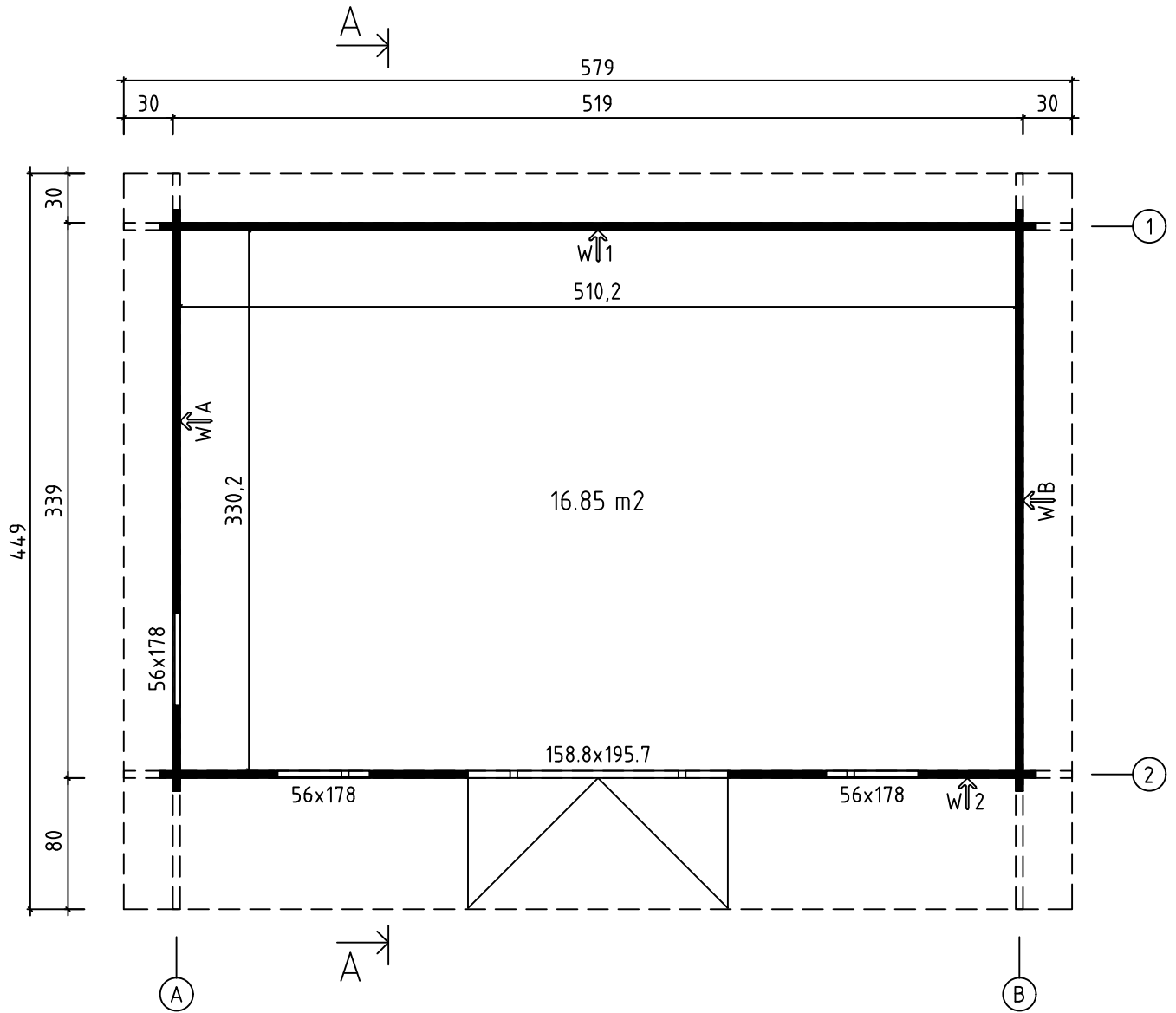

15.01.2018

Groundplan - Grundplan - Plan de masse - Planimetria - Plattegrond - Põhiplaan



Foundation - Fundament - Fondation - Fundamenta - Fundering - Immutatud alusraam





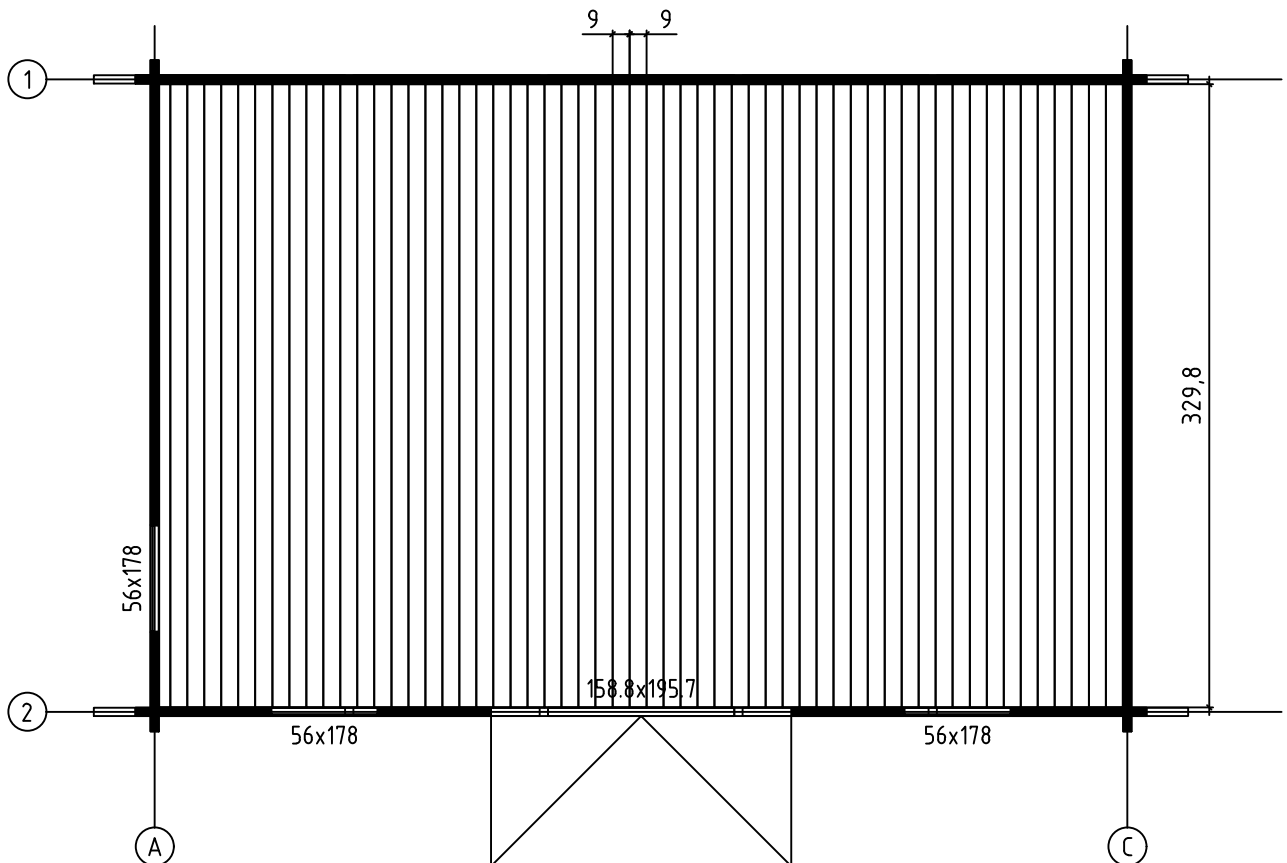

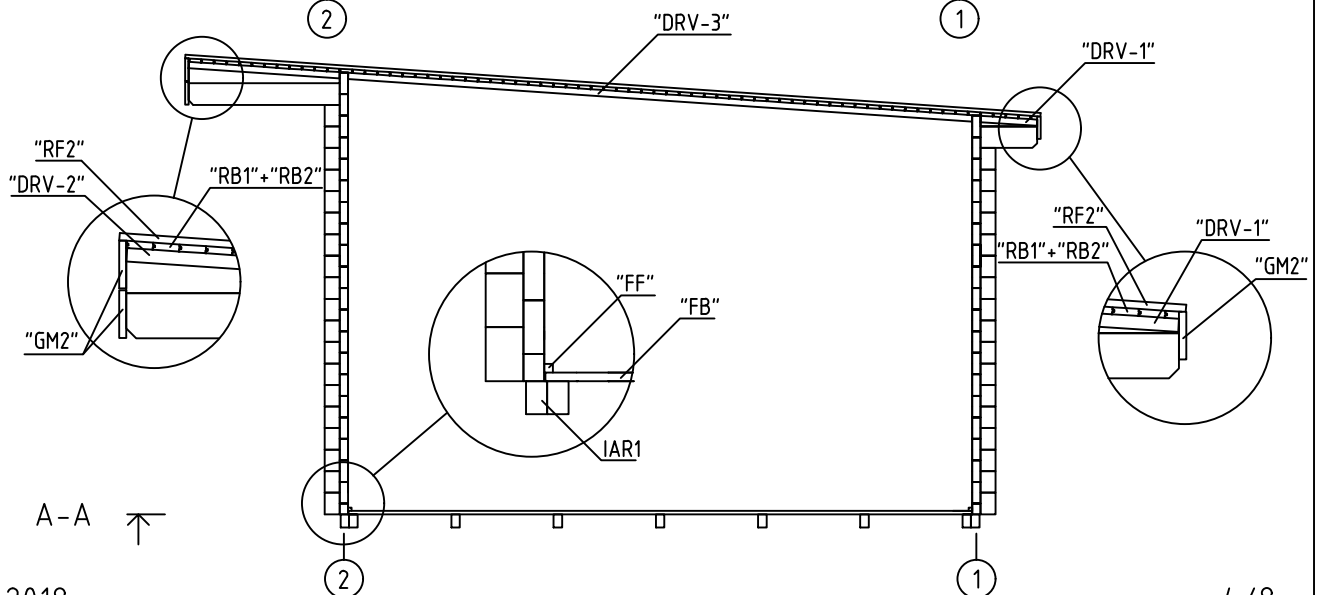
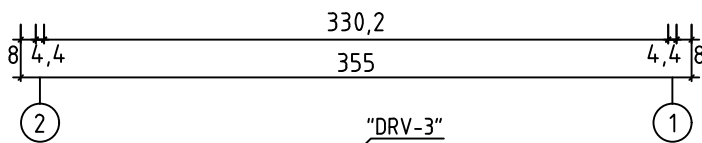
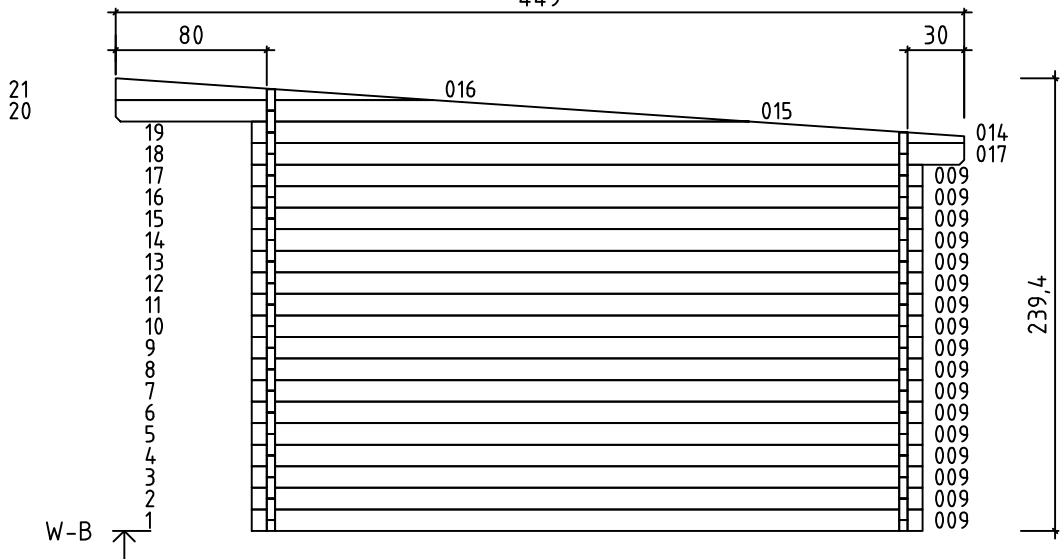
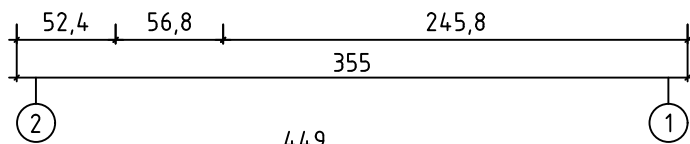
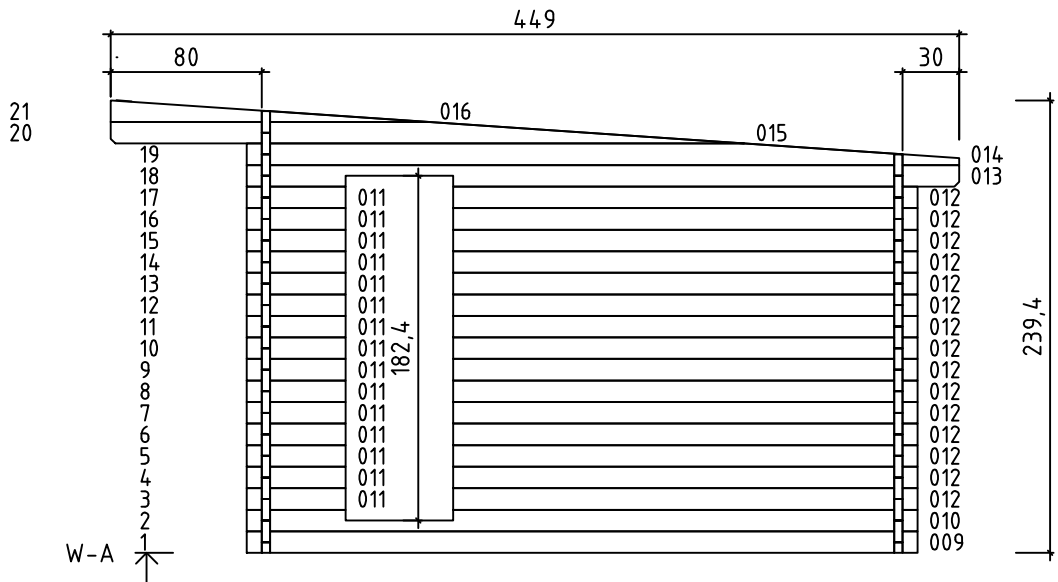

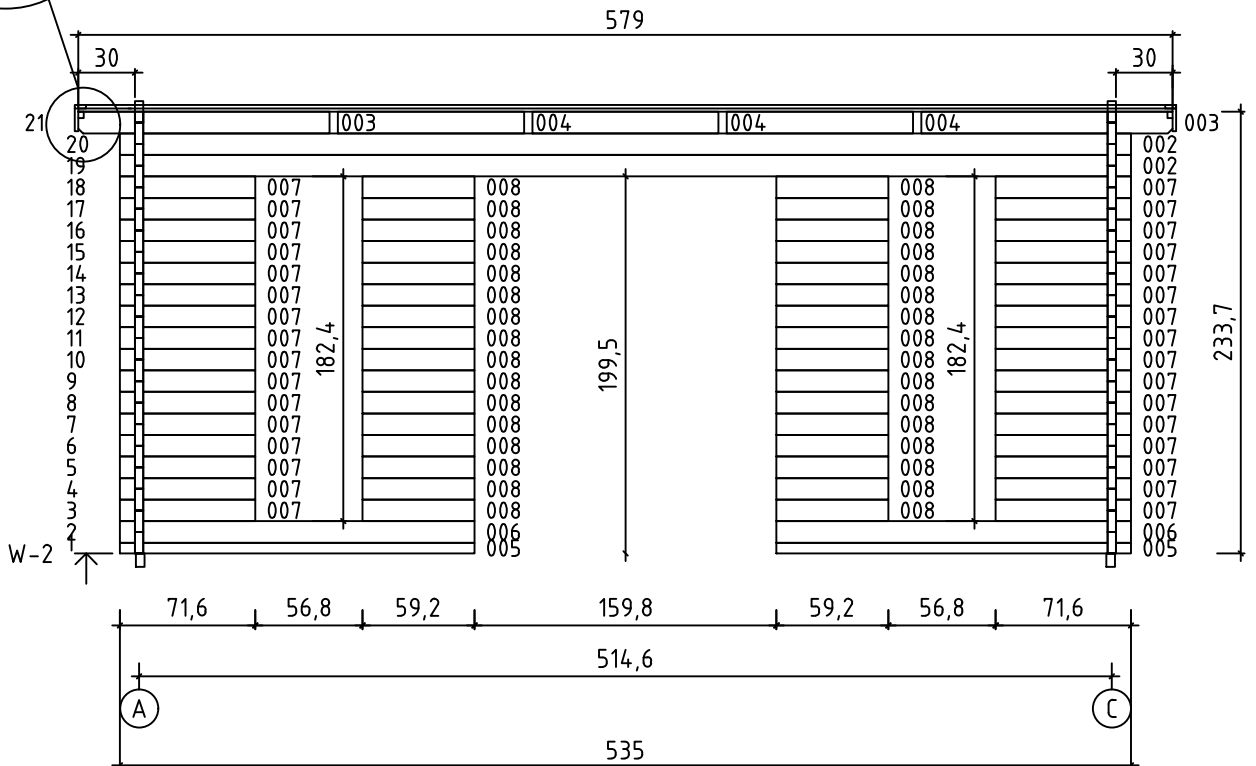
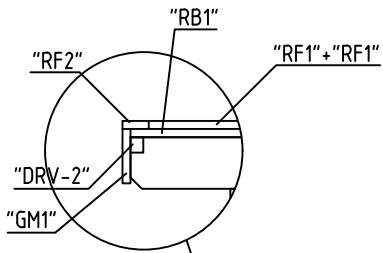
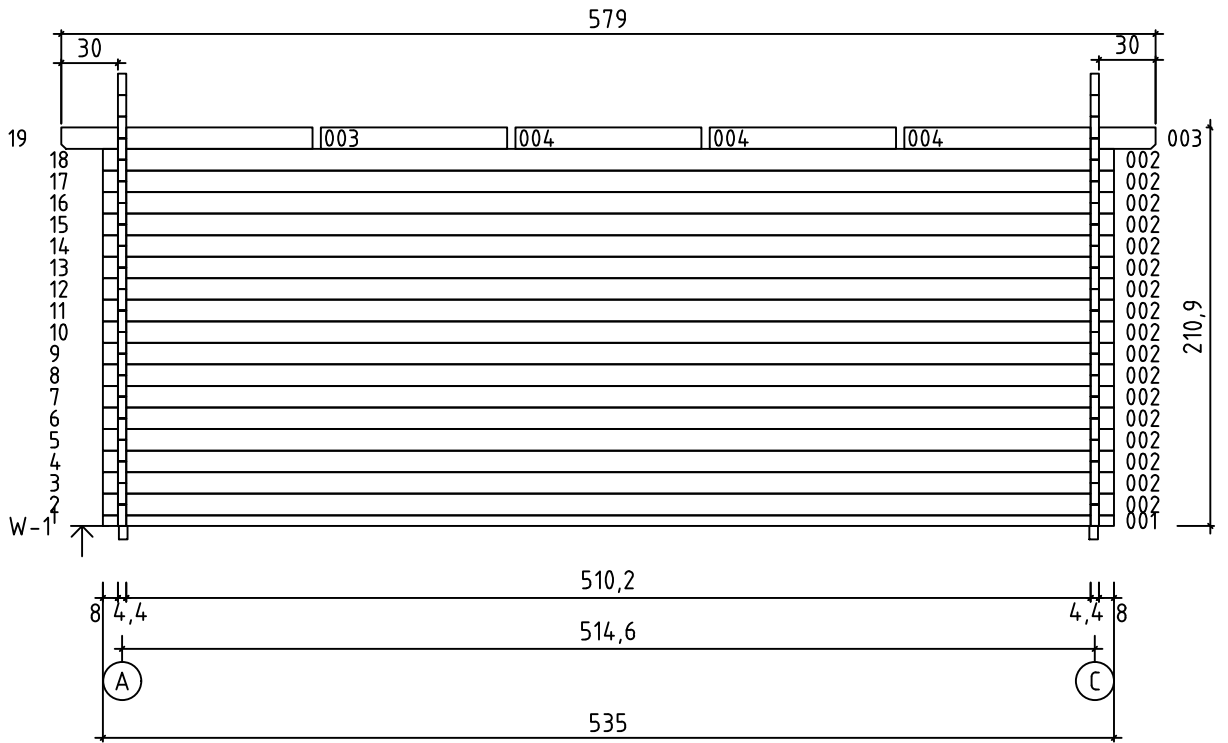

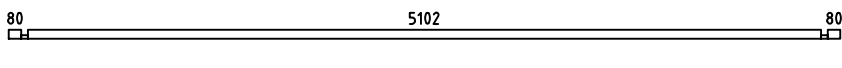
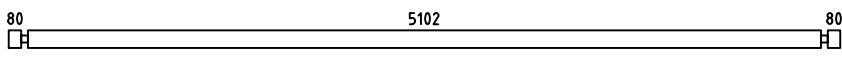
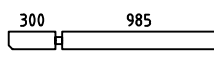
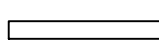
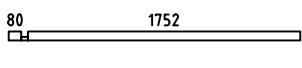
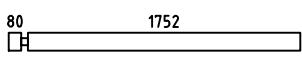
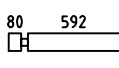
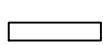
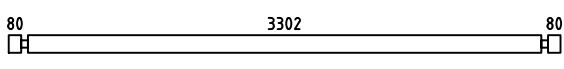
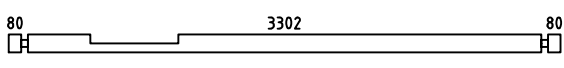
Floor boards - Fussbodenbretter - Plan pose placher - Pavimento - Vloerhout - Põrandalaudis

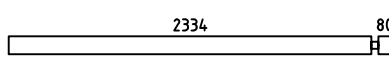
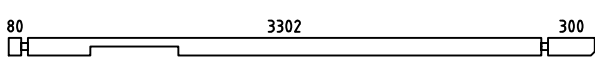
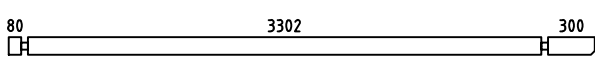
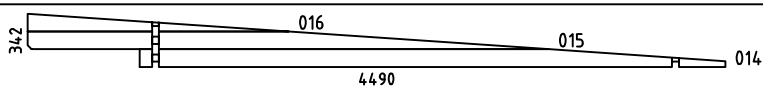
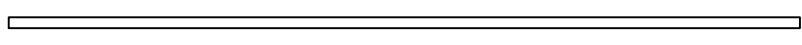
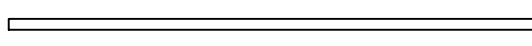
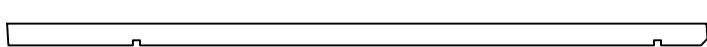

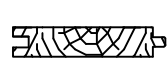



Pos	Piece list - Stückliste - Liste des pièces - Elementi - Stuklijst - Tükitalabel 15.01.2018 Art. Nr. 4414502	6/8	Q	P (mm)	L (mm)
001			1	44x57	5350
002			19	44x114	5350
003			4	44x114	1329
004			6	44x114	985
005			2	44x57	1876
006			2	44x114	1876
007			32	44x114	716
008			32	44x114	592
009			18	44x114	3550
010			1	44x114	3550
011			15	44x114	524
012			15	44x114	2458
013			1	44x114	3770
017			1	44x114	3770
WA-1 WB-1			1 1		
IAR2	Foundation - Fundament - Fondation - Fondamenta - Fundering - Immutatud alusraam 		9	45x70	5090
IAR1	Foundation - Fundament - Fondation - Fondamenta - Fundering - Immutatud alusraam 		2	45x70	3380
SR1	Rafter - Dachsparren - Chevron - Trave - Dak spar - Sarikas 		4	44x140	4510
FB	Floor boards - Fussbodenbretter - Lame de plancher - Pavimento - Vloerhout - Põrandalaud 		57	90x18	3298
RB1	Roof boards - Dachbretter - Voliges - Perlina per tetto - Dakhout - Katuselaud 		51	90x18	4439
RB2	Roof boards - Dachbretter - Voliges - Perlina per tetto - Dakhout - Katuselaud 		51	90x18	1351
FF	Floor fillet - Fussbodenteiste - Corniere de finition du plancher - Finitura per pavimento (battisco pa) - Vloerafwerklijst - Põrandaliist 			18x18	16.79
RF1	Roofing felt fillet - Dachpappenleiste - Baguette de fixation du feutre bitumeux - Asse per fissaggio guaina bituminosa - Afdekljst asfaltpapier - Katusepapiiist 		2	18x58	2855

Pos	Piece list - Stückliste - Liste des pièces - Elementi - Stuklijst - Tükitalabel 15.01.2018 Art. Nr. 4414502	7/8	Q	P (mm)	L (mm)
RF2	Roofing felt fillet - Dachpappenleiste - Baguette de fixation du feutre bitumeux - Asse per fissaggio guaina bituminosa - Afdekljst asfaltpapier - Katusepapiilist		2	18x58	4536
DRV-1	Roof edge reinforcement - Dachrandverstärkung - Corniere de renfort de bord de toit - Rinforzo x tetto - Dakrand versterking - Räästatugevdus		2	28x34	297
DRV-2	Roof edge reinforcement - Dachrandverstärkung - Corniere de renfort de bord de toit - Rinforzo x tetto - Dakrand versterking - Räästatugevdus		2	28x34	800
DRV-3	Roof edge reinforcement - Dachrandverstärkung - Corniere de renfort de bord de toit - Rinforzo x tetto - Dakrand versterking - Räästatugevdus		2	28x34	3306
KFS-1	Storm protection - Sturmleiste - Latte anti-tempete - Protezione anti vento - Stormverankering / beveliging - Tormikinnusliist		2	22x45	2050
KFS-2	Storm protection - Sturmleiste - Latte anti-tempete - Protezione anti vento - Stormverankering / beveliging - Tormikinnusliist		2	22x45	2500
GM 1	Gable moulding - Giebelleiste - Planche de rive - Finitura per frontale e retro del tetto - Gevellijst - Viilulaud		2	18x120	4510
GM 2	Gable moulding - Giebelleiste - Planche de rive - Finitura per frontale e retro del tetto - Gevellijst - Viilulaud		3	18x120	5826
HS9	Screw for gable moulding - Schrauben für giebelleiste - Vis pour fixation planche de rive - Vite per fissare finiture davanti e dietro del tetto - Schroef voor gevellijst - Kruvi viilulauale		66	3.5x50	
HS12	Screw for roof edge reinforcement - Schrauben für dachrandverstärkung - Vis pour fixation corniere renfort de bord de toit - Viti x rinforzo bordo tetto - Schroef voor dakrand versterking - Kruvi räästatugevdusele		24	4x40	
HS18	Screw for roof beams - Schrauben für dachbalken - Vis pour fixation pannes de toit - Viti per perline del tetto - Schroef voor gordingen / dakbalken - Kruvi pärlinitele		12	5x120	
HS18	Screw for gable - Schrauben für giebel - Vis pour fixation des pignons - Viti per timpano - Schroef voor gevelpunt - Kruvi viilude kinnitamiseks		8	5x120	
HS16	Screw for 1. wall beam - Schraube für 1. bohlenreihe - Vis de fixations 1ere rangée de madriers avec poutrelles de fondations - Vite fissaggio alle fondamenta - Schroef voor 1 wandbalk - Kruvi poollauale		8	5x90	
HS16	Screw for foundation - Schrauben zur befestigung fundament - Vis de fixations des poutrelles de fondations - Viti x fondamenta - Schroef voor fundering - Kruvi alusraamile		26	5x90	
HS23	Screw for pos. 003-004 - Schrauben für pos. 003-004 - Vis pour pos. 003-004 - Viti per fissare elemento vedi figura in pos. n. 003-004 - Schroef voor pos. 003-004 - Kruvi pos. 003-004		10	6x180	
NF2	Zn nail for floor fillet - Zn nägel für fussbodenleiste - Pointe pour corniere de finition du plancher - Chiodi x fissaggio pavimento - Spijker(nagel) voor vloer - Nael põrandaliistule		34	1.4x40	
SH44	Hammer block - Schlagholz - Calle de frappe - Blocco di legno da usare come cuscinetto quando si usa il martello - Slagklos - Löögiklots		1		
SFS	Nut for storm protection - Schraubenmutter für sturmleiste - Ecrou pour latte anti-tempete - Dado x asta protezione vento - Moer voor stormverankering - Mutter tormikinnusliistule		8	D8	
NF4	Zn nail for roof - Zn nägel für dachbretter - Pointe pour fixation voliges de toit - Chiodi x perline tetto - Spijker(nagel) voor dakhout - Nael katuselauale		374	2x50	
NF4	Zn nail for floor - Zn nägel für fussbodenbretter - Clous pour plancher - Chiodi x perline pavimento - Spijker(nagel) voor vloer - Nael põrandalauale		406	2x50	
NF5	Zn nail for roofing felt fillet - Zn nägel für dachpappenleiste - Pointe pour baguette de fixation feutre bitumeux - Chiodi x carta bituminosa x tetto - Spijker(nagel) voor asfaltpapier afdekljst - Papiilistunael		34	2x40	
BFS	Bolt for storm protection - Bolzen für sturmleiste - Boulon pour latte anti-tempete - Bullone x asta protezione vento - Bout voor stormankertlat - Puidupolt tormikinnusliistule		8	8x80	
DFS	Washer for storm protection - Dichtscheibe für sturmleiste - Rondelle pour latte anti-tempete - Rondella x asta protezione vento - Afdichtring voor storm strip - Seib tormikinnusliistule		8	D8	







Pos	10.11.2017	Piece list - Stückliste - Liste des pièces - Elementi - Stuklijst - Tükítabel 560x1780 AK.1.100.TPSP DGP+	1/1	Q	P (mm)	L (mm)
-----	------------	--	-----	---	-----------	-----------

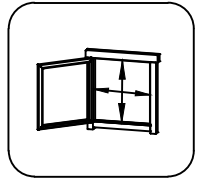
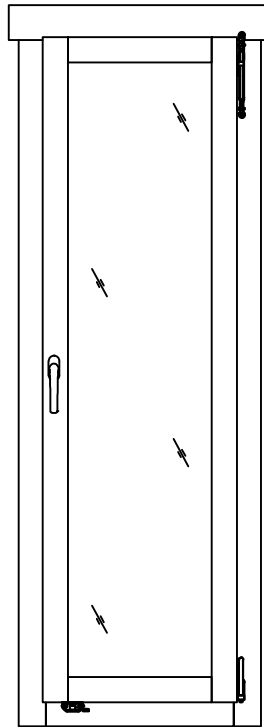



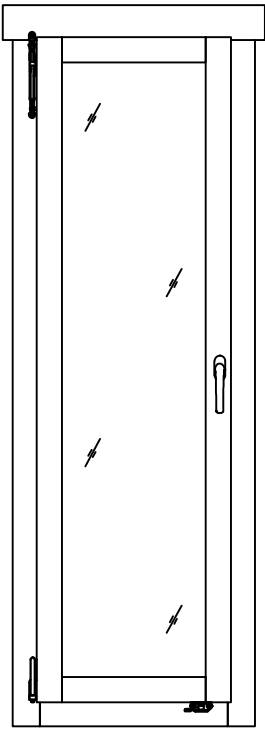
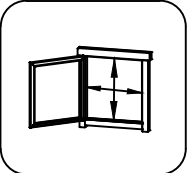

Glass size - Glasgröße - Taille de la vitre - Misura del vetro - Glas afmeting - Klaasi mõõt: 390x1602 mm

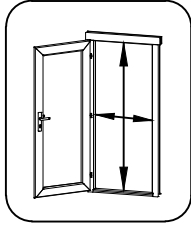
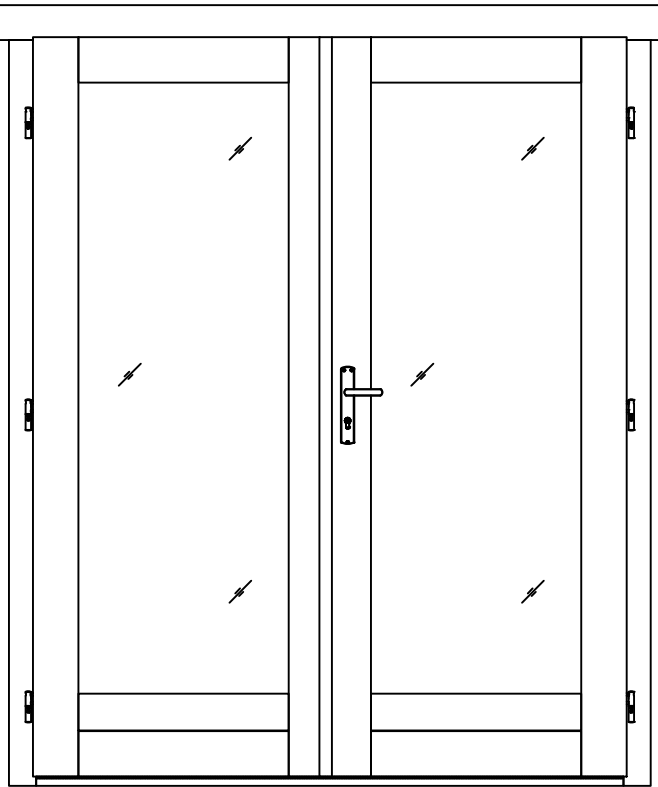
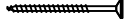
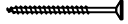
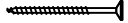

460x1684 mm

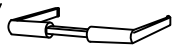
FS2	Window handle fittings - Fenstergriff - Poignee de fenetre - Maniglia c/ferramenta - Raamhendel -/grendel -/klink - Aknalink		1		
-----	---	---	---	--	--

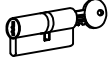
Pos	10.11.2017 Piece list - Stückliste - Liste des pièces - Elementi - Stuklijst - Tükitalabel 560x1780 AK.1.100.TPSV DGP+	1/1	Q	P (mm)	L (mm)
	<p data-bbox="255 152 1289 183">Glass size - Glasgröße - Taille de la vitre - Misura del vetro - Glas afmeting - Klaasi mõõt: 390x1602 mm</p>   <p data-bbox="1364 347 1497 376">460x1684 mm</p>				
FS2	<p data-bbox="255 2132 1024 2190">Window handle fittings - Fenstergriff - Poignee de fenetre - Maniglia c/ferramenta - Raamhendel -/grendel -/klink - Aknalink</p>		1		

Pos	Piece list - Stückliste - Liste des pièces - Elementi - Stuklijst - Tükitalabel 1588x1957 TUK.1.100.TPVP.MM DGP+	1/1	Q	P (mm)	L (mm)
	Glass size - Glasgröße - Taille de la vitre - Misura del vetro - Glas afmeting - Klaasi mõõt: 561x1593 mm			 1488x1873 mm	
					
HS4	Screw for door fillet - Schraube zur Befestigung türleiste - Vis pour fixation baguette d'arret de porte - Viti per massellino della porta - Schroef voor deurlijst - Kruvi ukse kokkuvaltšiliistule		5	3x30	
HS16	Screw for door jamb - Schraube für Türrahmen - Vis de fixation partie haute avec montants du cadre de porte - Viti x fissaggio montanti porte - Schroef voor deurkozijn - Kruvi ukse lengile		4	5x90	
HS25	Screw for doorstep - Schrauben für swelle - Vis pour fixation barre de seuil - Vite per soglia della porta - Schroef voor deurdorpel - Kruvi lävepakule		3	4.5x65	
MH	Male bolt hinge for door - Türband - Partie male de paumelle de porte - Cerniera anube x porta - Scharnier bout - Reguleeritav polthing isane		6	14x80	
HC	Covers for door hinges - Schutzkappe für Türband - Couverture de paumelle de porte - Copertura delle cerniere della porta - Afdek kap voor deurscharnier - Reguleeritava polthinge kate		12		
TL4	Door handle fittings - Türgriff - Poignée de porte - Maniglie - Deurhendel / klink - Ukse käepide		1		
TL5	Set of door lock covers - Schlossblenden - Set de garnitures de porte - Copertura serrature - Slot sluitplaat set - Ukse lukuplaat		1		
	Cylinder lock - Zylinderschloss - Barillet de porte - Serratura - Cylinder slot - Ukse lukusüdamik		1	30x35	
	Striker for barrel bolt - Hülse für Grendelriegel - Gache au sol du targette - Boccola per fermo della porta - Huls voor vergrendelingsschuif - Vasturaud ukse servariivile		2		