

GOTLAND 2E
ART.NR. 440400
1/6

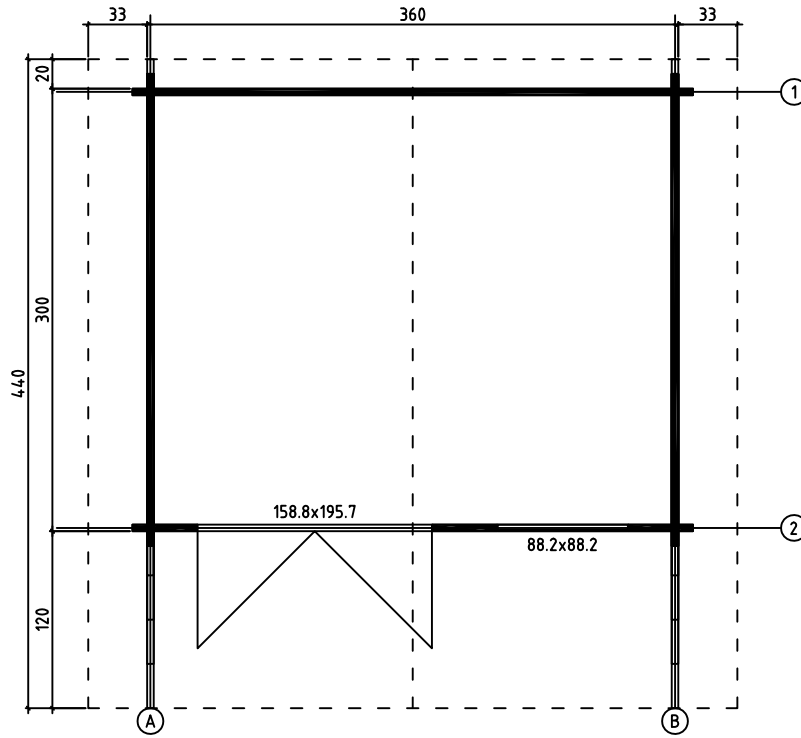

GROUNDPLAN - GRUNDPLAN - PLAN DE MASSE





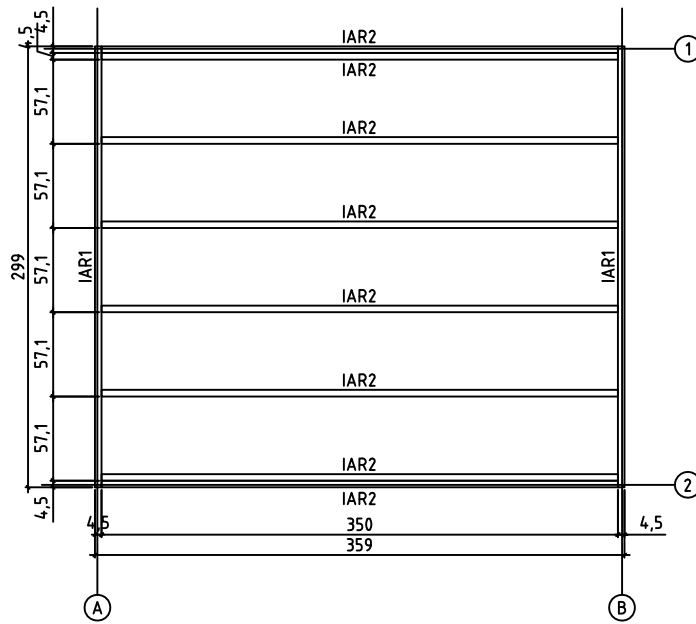



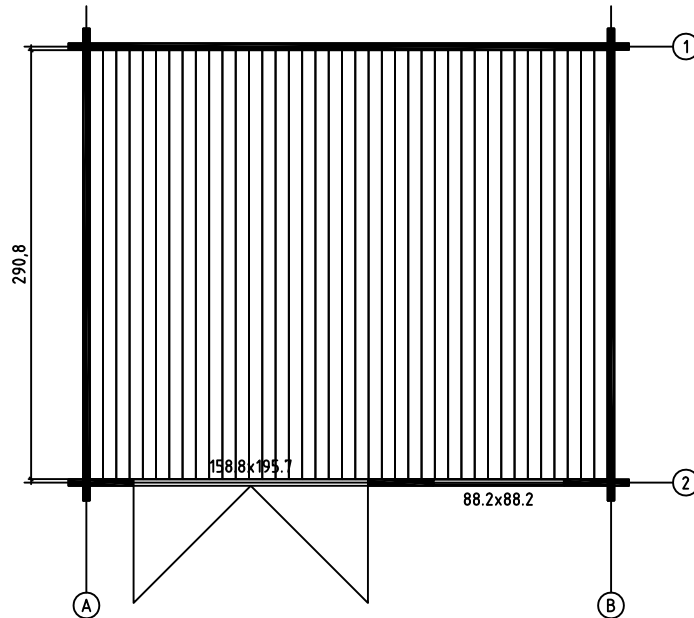

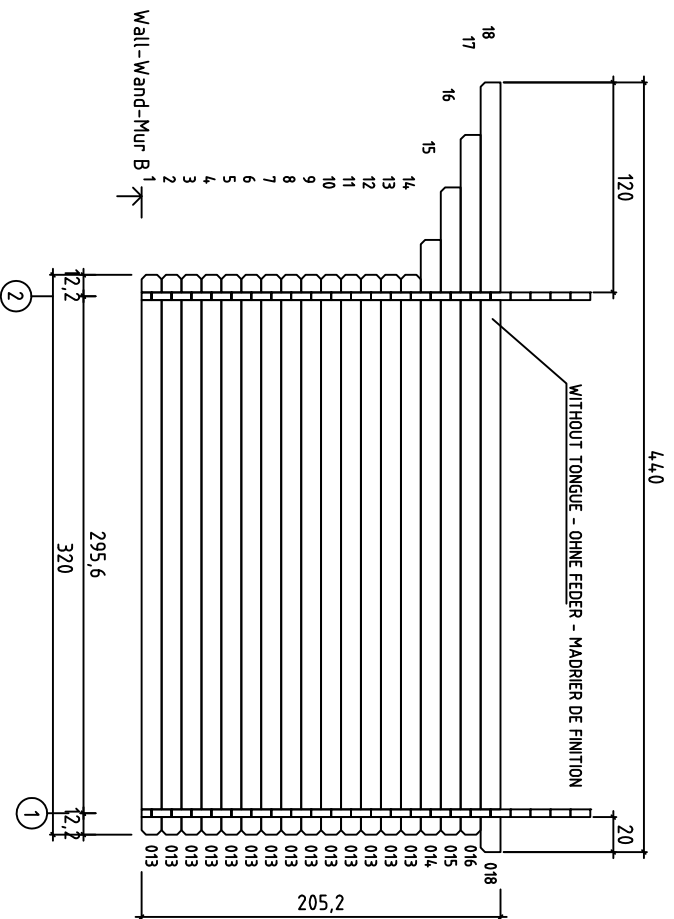
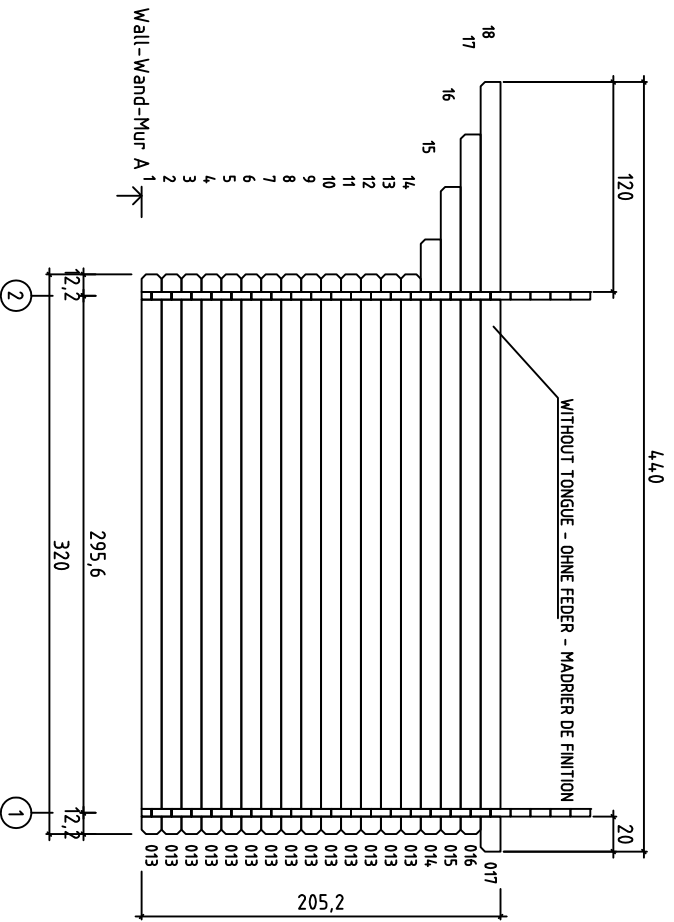
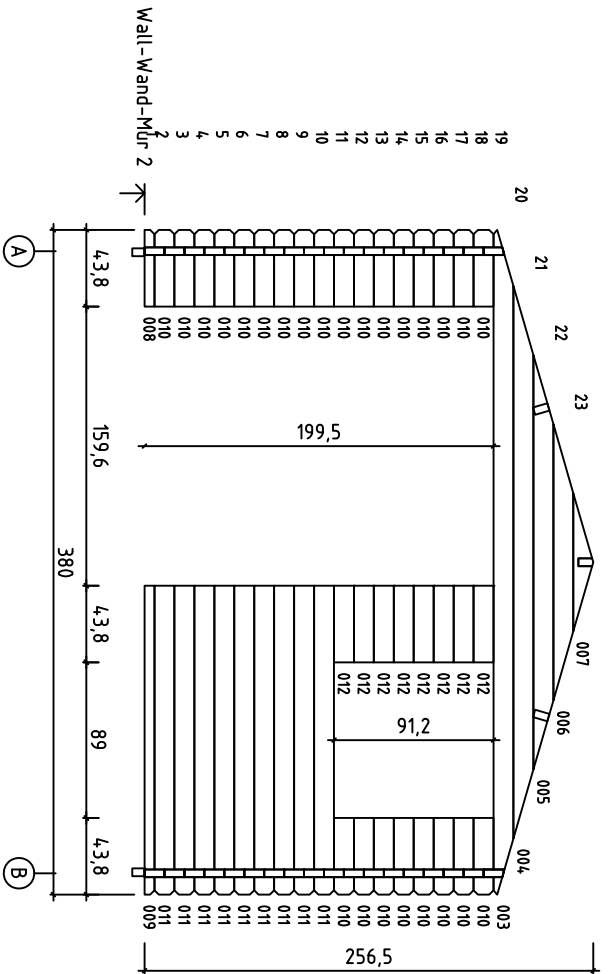
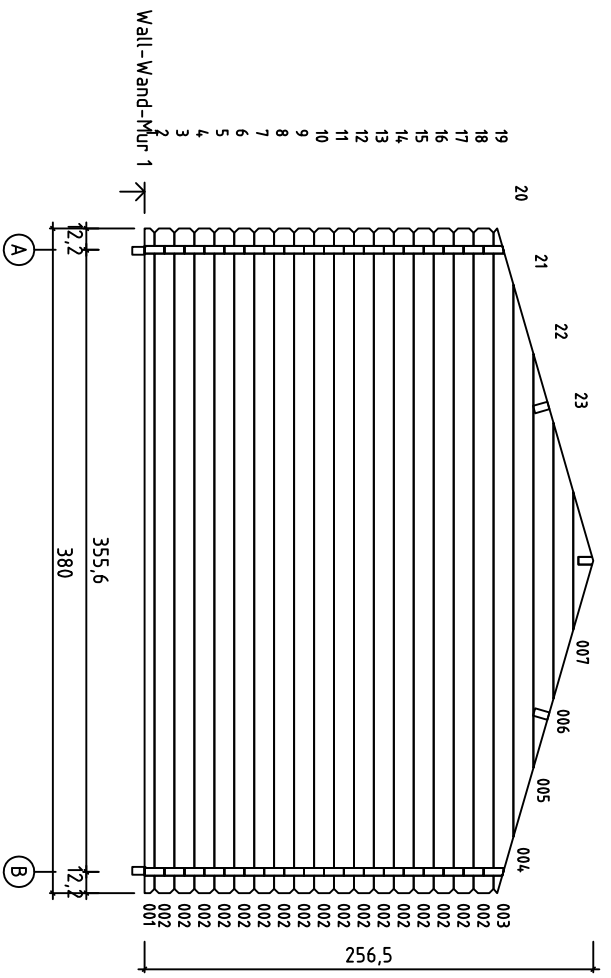

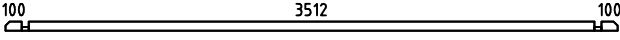
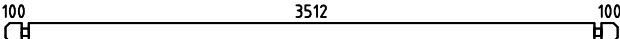

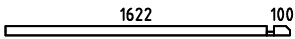

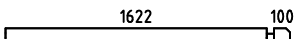
FOUNDATION - FUNDAMENT - FONDATION

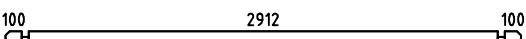
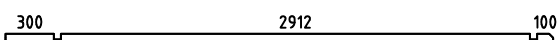

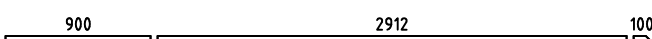

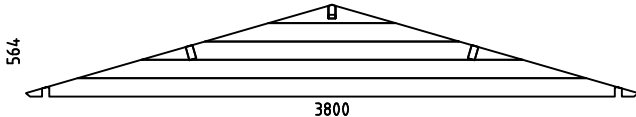
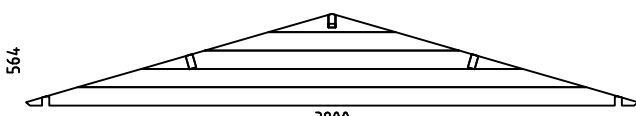
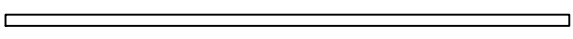
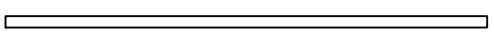
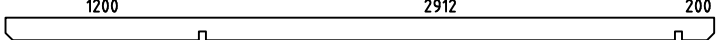
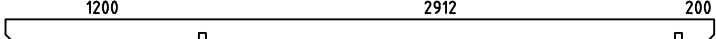





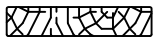

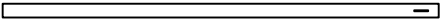

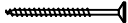
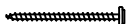





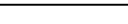

FLOOR BOARDS - FUSSBODENBRETTER - PLAN POSE PLANCHER



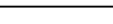
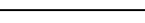

Pos	04.01.2011	ART.NR. 440400	4/6	St.	Profile (mm)	Lenght (mm)
001				1	44x57	3800
002				17	44x114	3800
008				1	44x57	438
009				1	44x57	1766
010				25	44x114	438
011				9	44x114	1766
012				8	44x114	438
013				28	44x114	3200
014				2	44x114	3400
015				2	44x114	3700
016				2	44x114	4000
017				1	44x120	4400
018				1	44x120	4400
W1-1				1		
W2-1				1		
IAR2	FOUNDATION - FUNDAMENT - FONDATION 			8	45x70	3500
IAR1	FOUNDATION - FUNDAMENT - FONDATION 			2	45x70	2990
PR11	ROOF BEAM - DACHBALKEN - PANNE DE TOIT 			1	44x140	4400
PR21	ROOF BEAM - DACHBALKEN - PANNE DE TOIT 			2	44x140	4400
	FLOOR BOARDS - FUSSBODENBRETTER - LAME DE PLANCHER 			39	90x18	2908
	ROOF BOARDS - DACHBRETTER - VOLIGES 			98	90x18	2200
	FLOOR FILLET-FUSSBODENLEISTE - CORNIERE DE FINITION DU PLANCHER 				18x18	12.83
	ROOFING FELT FILLET - DACHPAPPENLEISTE - BAGUETTE DE FIXATION DU FEUTRE BITUMEUX 			4	18x58	2250

Pos	04.01.2011	ART.NR. 440400	5/6	St.	Profile (mm)	Lenght (mm)
	EAVES BOARD - TRAUFBRETT - BANDEAU DE TOIT			2	18x90	4400
	ROOF EDGE REINFORCEMENT - DACHRANDVERSTÄRKUNG - CORNIERE DE RENFORT DE BORD DE TOIT			2	28x34	4400
	STORM PROTECTION - STURMLEISTE LATTE ANTI-TEMPETE			4	22x45	2000
	GABLE MOULDING - GIEBELLEISTE PLANCHE DE RIVE			4	18x120	2250
	WINDOW HANDLE FITTINGS-FENSTERGRIFF - POIGNÉE D'OUVERTURE DE FENETRE			1		
	SCREW FOR GABLE SEGMENT - SCHRAUBEN FÜR DECKBLATT - VIS POUR FIXATION LOSANGE DE FINITION			4	3.5x35	
	SCREW FOR DOORSTEP - SCHRAUBEN FÜR SWELLE - VIS DE FIXATION DU SEUIL DE PORTE			3	4.5x65	
	SCREW FOR GABLE MOULDING - SCHRAUBEN FÜR GIEBELLEISTE - VIS DE FIXATION POUR PLANCHE DE RIVE			24	3.5x50	
	SCREW FOR DOOR FILLET - SCHRAUBE ZUR BEFESTIGUNG TÜRLEISTE VIS D'ASSEMBLAGE DU CADRE DE PORTE			5	3x30	
	SCREW FOR EAVES BOARDS - SCHRAUBEN FÜR TRAUFBRETT - VIS DE FIXATION POUR BANDEAU DE TOIT			20	4x40	
	SCREW FOR ROOF EDGE REINFORCEMENT - SCHRAUBEN FÜR DACHRANDVERSTÄRKUNG - VIS POUR RENFORT DE BORD DE TOIT			20	4x40	
	SCREW FOR ROOF BEAMS - SCHRAUBEN FÜR DACHBALKEN - VIS POUR PANNE DE TOIT			10	5x120	
	SCREW FOR 1. WALL BEAM - SCHRAUBE FÜR 1. BOHLENREIHE - VIS DE FIXATION DES FONDATIONS			5	5x90	
	SCREW FOR FUNDAMENT - SCHRAUBEN ZUR BEFISTIGUNG FUNDAMENT - VIS POUR FONDATION			18	5x90	
	SCREW FOR DOOR JAMB - SCHRAUBE FÜR TÜRRAHMEN - VIS DE FIXATION POUR MONTANT DE PORTE			4	5x90	
	ZN NAIL FOR FLOOR FILLET - ZN NÄGEL FÜR FUSSBODENLEISTE - POINTE POUR CORNIERE DE FINITION DU PLANCHER			26	1.4x40	
	HAMMER BLOCK - SCHLAGHOLZ - CALLE DE FRAPPE			1		
	ZN NAIL FOR ROOFING FELT FILLET - ZN NÄGEL FÜR DACHPAPPENLEISTE - POINTE POUR BAGUETTE FIXATION FEUTRE BITUMEUX			24	2x40	
	BOLT FOR WINDOW HANDLE FITTINGS - BOLZEN FÜR FENSTERGRIFF BESCHLAG - BOULON POUR POIGNÉE D'OUVERTURE DE FENETRE			2		
	GABLE SEGMENT-DECKBLATT - LOSANGE DE FINITION			2		
	NUT FOR STORM PROTECTION - SCHRAUBENMUTTER FÜR STURMLEISTE - ÉCROU POUR LAME ANTI-TEMPETE			8		
	BOLT FOR STORM PROTECTION - BOLZEN FÜR STURMLEISTE - VIS POUR LAME ANTI-TEMPETE			8		
	WASHER FOR STORM PROTECTION - DICHTSCHEIBE FÜR STURMLEISTE - RONDELLE POUR LAME ANTI-TEMPETE			8		
	ZN NAIL FOR ROOF - ZN NÄGEL FÜR DACHBRETT - POINTE POUR TOIT			310	5x50	
	ZN NAIL FOR FLOOR - ZN NÄGEL FÜR FUSSBODENBRETT - CLOUS POUR PLANCHER			240	2x50	

