

Art.Nr. 407499

1/12

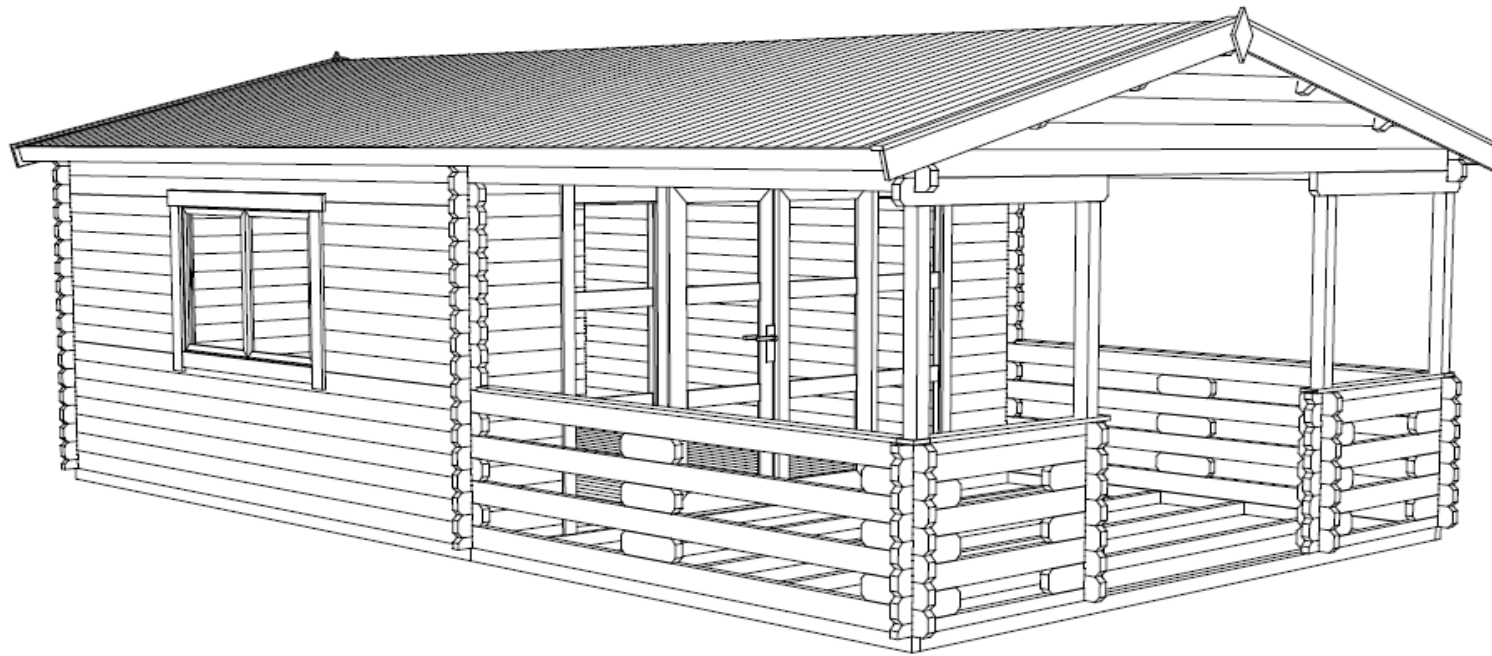

40x114
28.01.2013

Art.Nr. 407499
GROUNDPLAN - GRUNDPLAN - PLAN DE MASSE

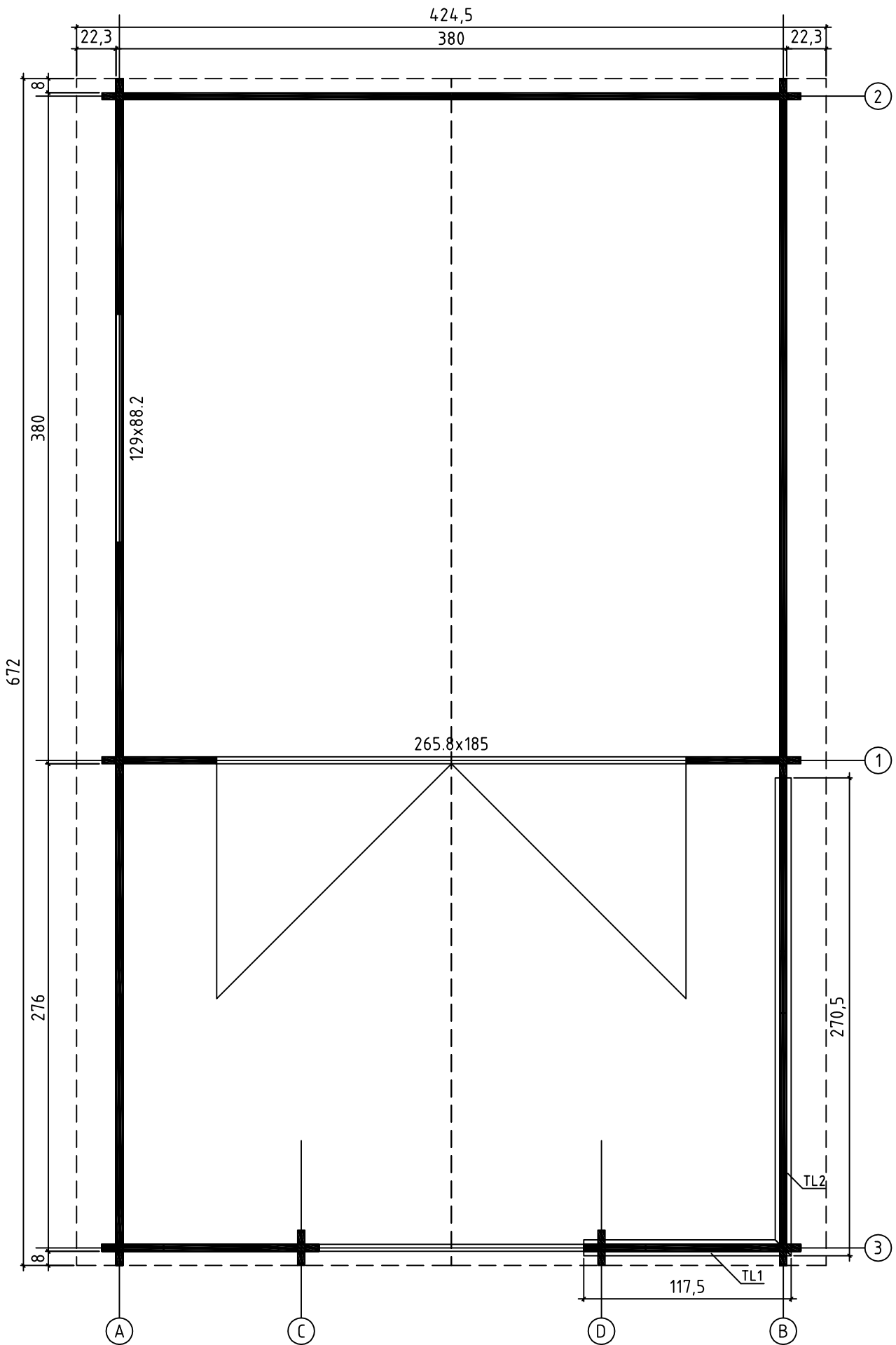

Art.Nr. 407499
FOUNDATION - FUNDAMENT - FONDAZIONE

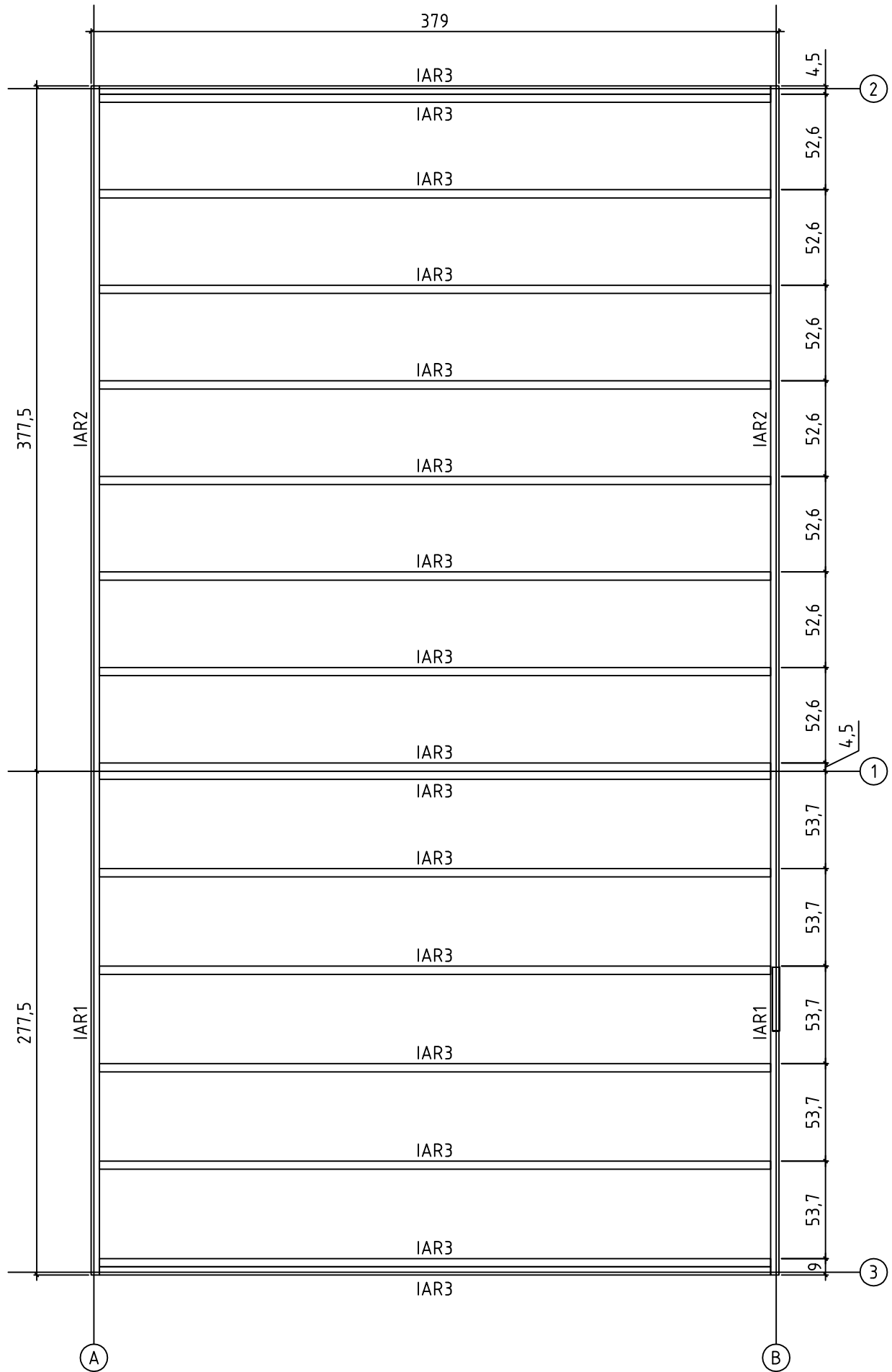





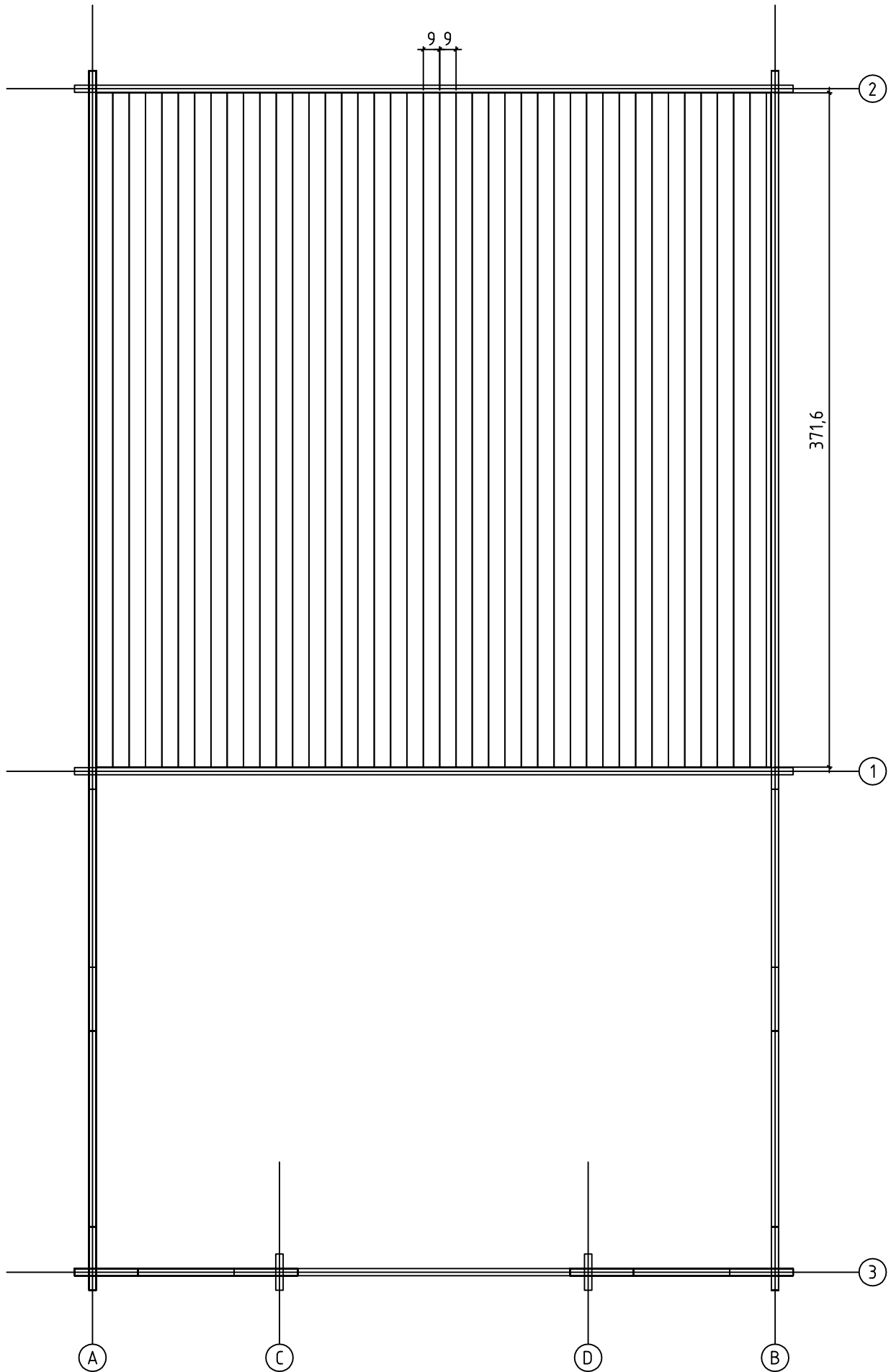

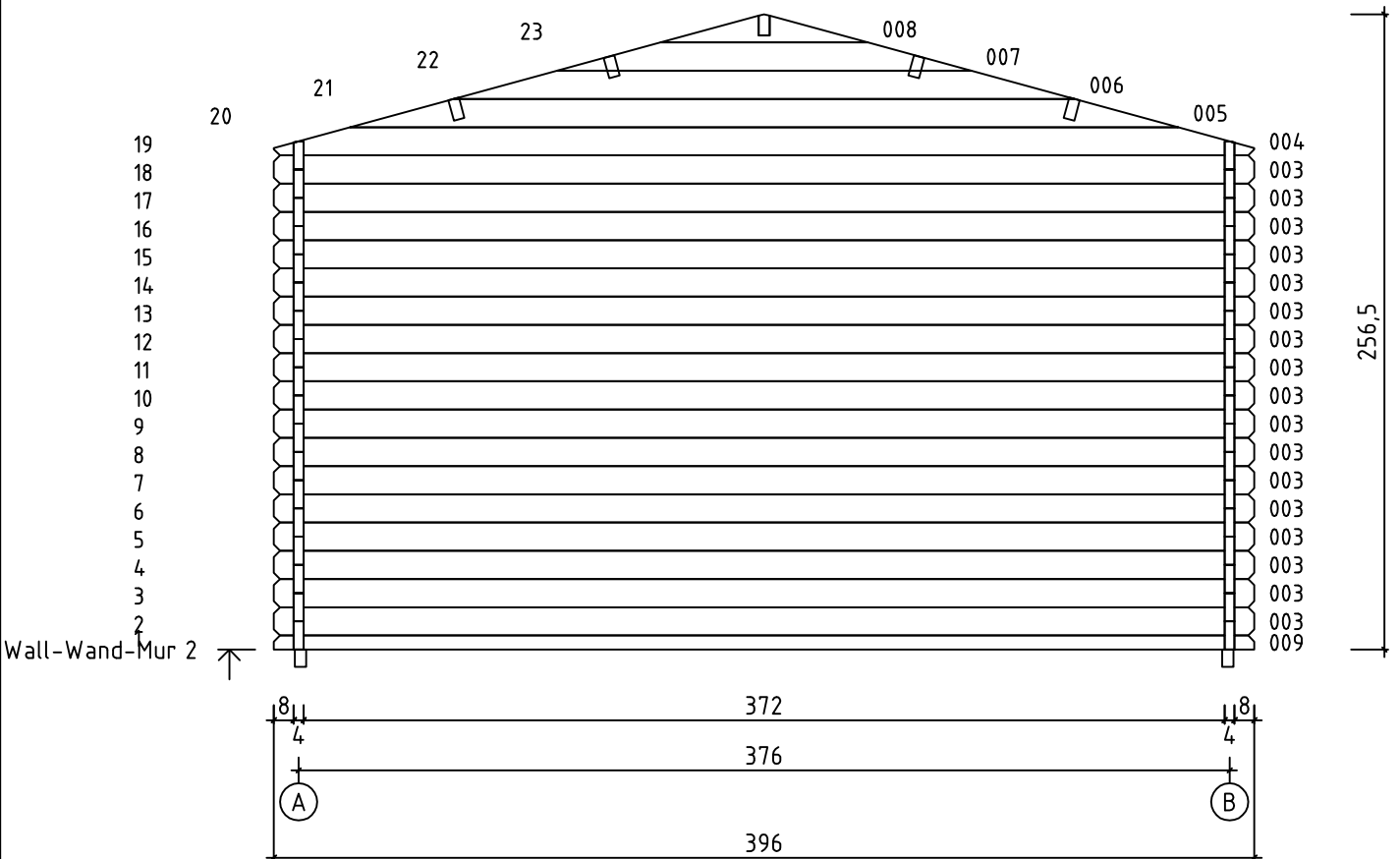
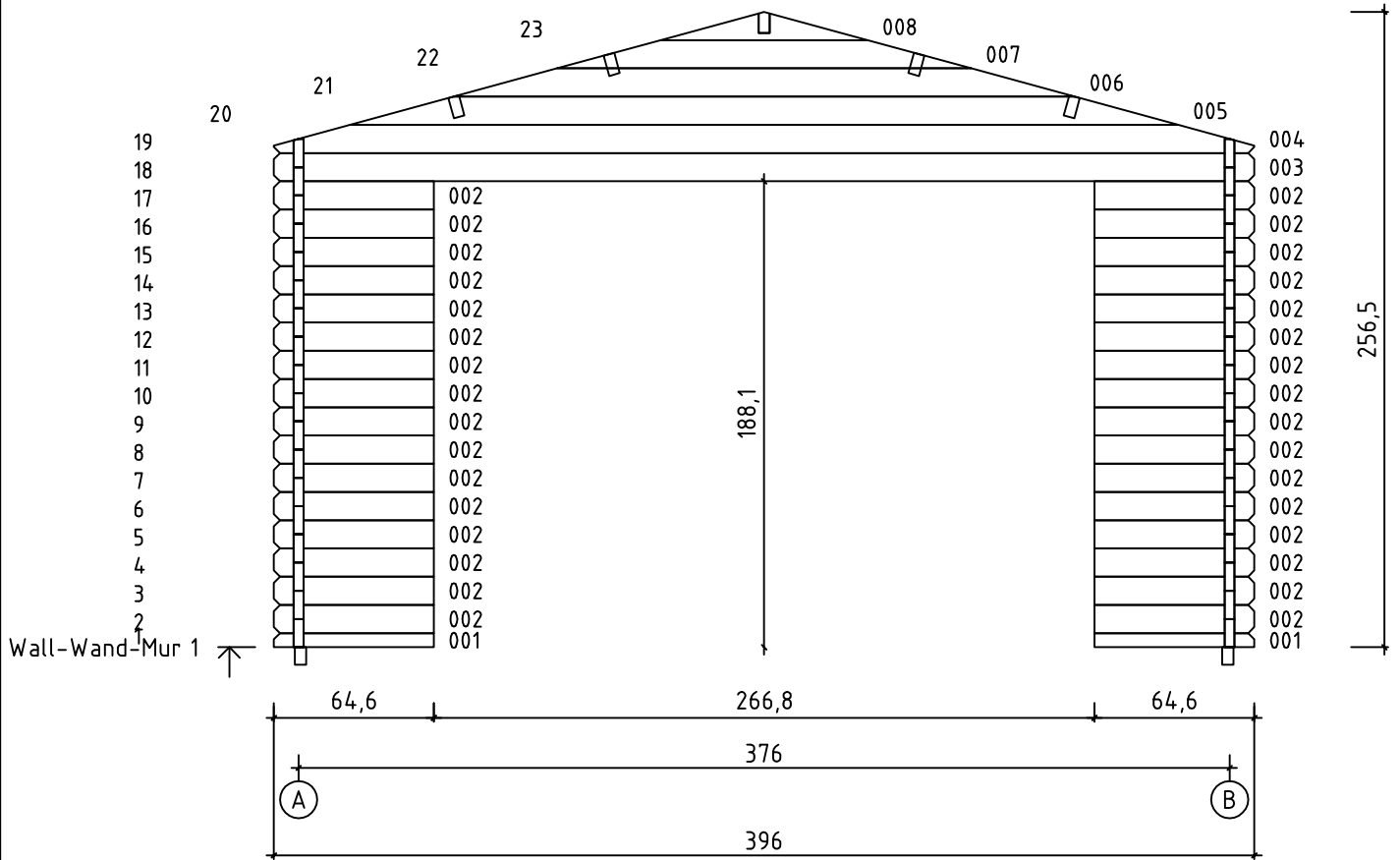
Art.Nr. 407499

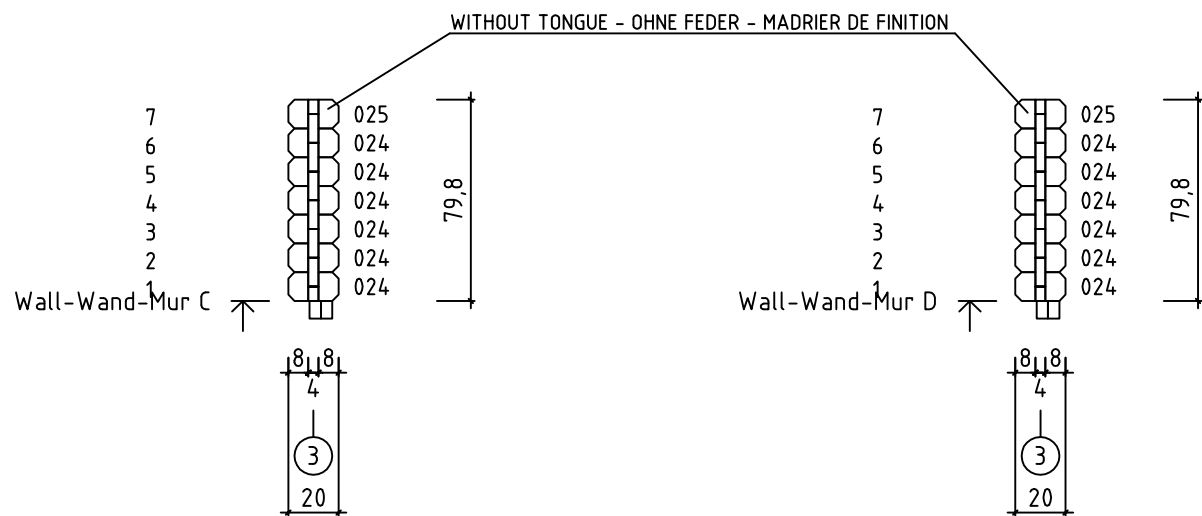
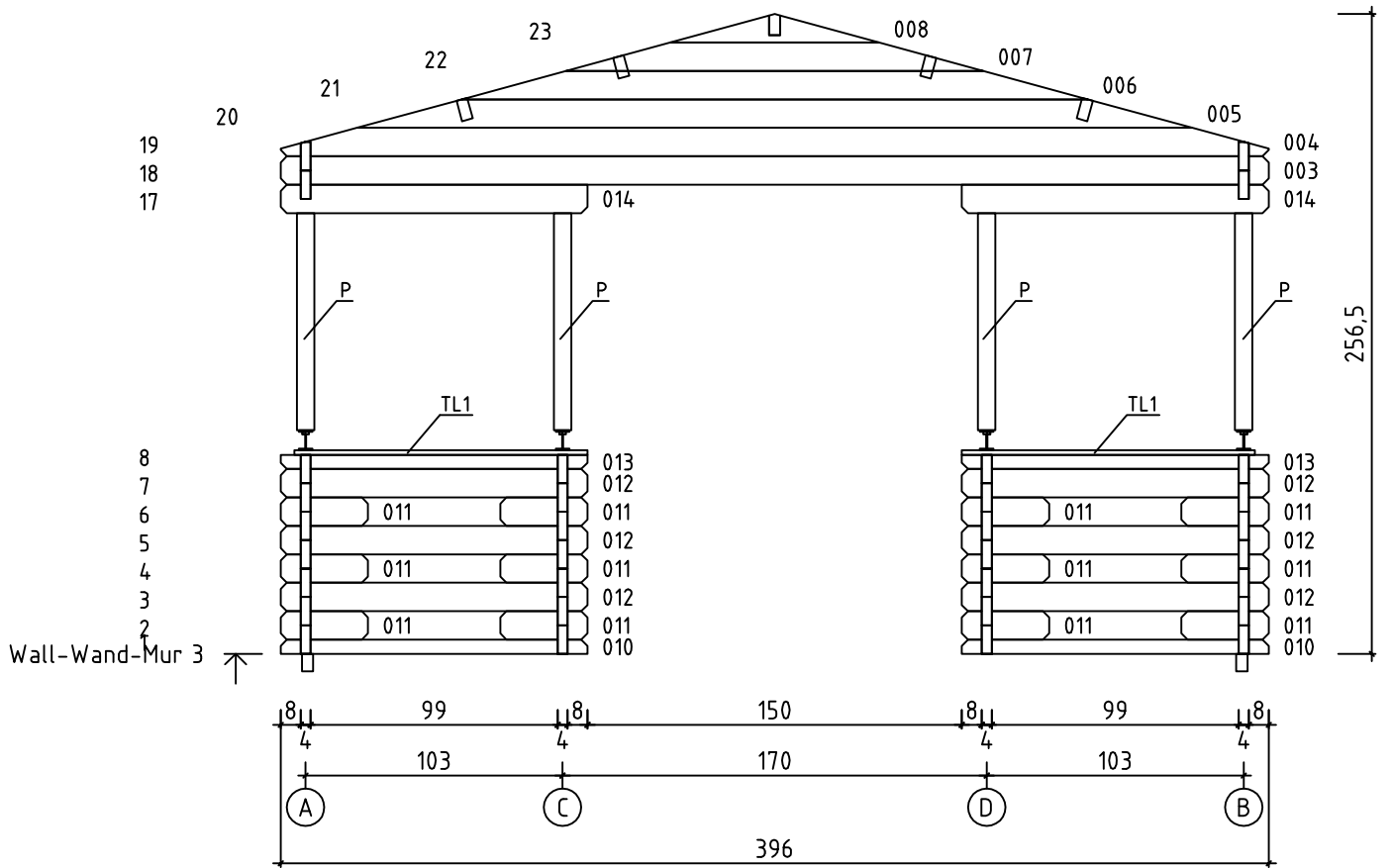
FLOOR BOARDS - FUSSBODENBRETTER - PLAN POSE PLANCHER

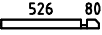
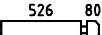
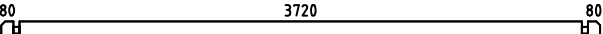
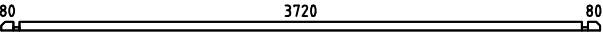
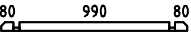

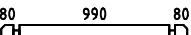
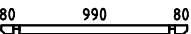
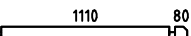
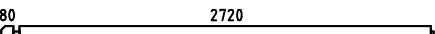
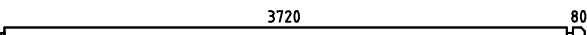

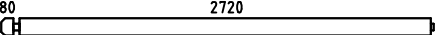
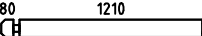
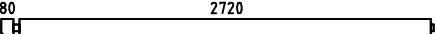
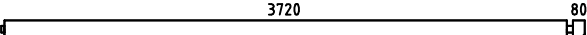
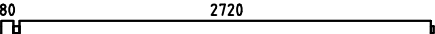
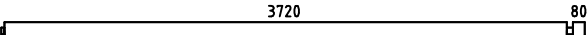

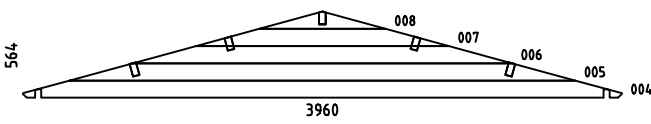
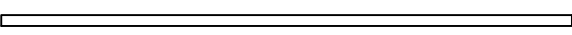
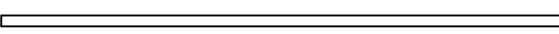
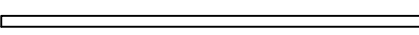



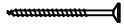
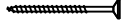
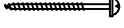
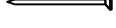

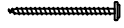
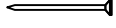
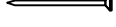
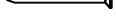

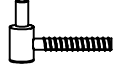

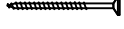

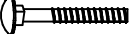

Pos	28.01.2013 Piecelist - Stücklist - Liste des composants Art.Nr. 407499	9/12	Q.	P. (mm)	L. (mm)
001			2	40x57	646
002			32	40x114	646
003			35	40x114	3960
009			1	40x57	3960
010			2	40x57	1230
011			18	40x114	350
012			6	40x114	1230
013			2	40x57	1230
014			2	40x114	1230
015			8	40x114	2860
016			10	40x114	3860
017			6	40x114	350
018			2	40x114	2860
019			16	40x114	1330
020			1	40x120	2860
021			1	40x120	3860
022			1	40x120	2860
023			1	40x120	3860
024			12	40x114	200
025			2	40x114	200
W1-1 W2-1 W3-1			1 1 1		
IAR2		FOUNDATION - FUNDAMENT - FONDATION	2	45x70	3775
IAR3		FOUNDATION - FUNDAMENT - FONDATION	16	45x70	3700
IAR1		FOUNDATION - FUNDAMENT - FONDATION	2	45x70	2775

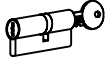
Pos	28.01.2013	Piecelist - Stücklist - Liste des composants Art.Nr. 407499	10/12	Q.	P. (mm)	L. (mm)
PR2		ROOF BEAM - DACHBALKEN - PANNE DE TOIT 3740 80		1	44x140	3860
PR1		ROOF BEAM - DACHBALKEN - PANNE DE TOIT 80 2740		1	44x140	2860
A-PR2		ROOF BEAM - DACHBALKEN - PANNE DE TOIT 3740 80		4	44x140	3860
A-PR1		ROOF BEAM - DACHBALKEN - PANNE DE TOIT 80 2740		4	44x140	2860
	FLOOR BOARDS - FUSSBODENBRETT - LAME DE PLANCHER			42	90x18	3716
	ROOF BOARDS - DACHBRETT - VOLIGES			150	90x18	2200
	FLOOR FILLET-FUSSBODENLEISTE - CORNIERE DE FINITION DU PLANCHER				18x18	14.86
	ROOFING FELT FILLET - DACHPAPPENLEISTE - BAGUETTE DE FIXATION DU FEUTRE BITUMEUX			4	18x58	2250
P	POST - PFOSTEN - POTEAU			4	70x70	928
	EAVES BOARD - TRAUFBRETT - BANDEAU DE TOIT			4	18x90	3360
	ROOF EDGE REINFORCEMENT - DACHRANDVERSTÄRKUNG - CORNIERE DE RENFORT DE BORD DE TOIT			4	28x34	3360
TL1	GUARD-RAIL FOR TERRACE - TERRASSEN GELÄNDER - MAIN COURANTE DE TERRASSE			2	18x90	1175
TL2	GUARD-RAIL FOR TERRACE - TERRASSEN GELÄNDER - MAIN COURANTE DE TERRASSE			2	18x90	2705
	STORM PROTECTION - STURMLEISTE - - LATTE ANTI-TEMPETE			4	22x45	2000
	GABLE MOULDING - GIEBELLEISTE - - PLANCHE DE RIVE			4	18x120	2250
	WINDOW HANDLE FITTINGS - FENSTERGRIFF - POIGNÉE D'OUVERTURE DE FENETRE			1		
	SCREW FOR GABLE SEGMENT - SCHRAUBEN FÜR DECKBLATT - - VIS POUR FIXATION LOSANGE DE FINITION			4	3.5x35	
HS4	SCREW FOR COVERING MOULDING - SCHRAUBEN FÜR DECKUNGSPROFIL - - VIS DE FIXATION PROFILS DE FINITION VERTICAUX A FIXER A L'EXTERIEUR DU CADRE DE LA PORTE			14	3.5x50	
	SCREW FOR POST - SCHRAUBEN FÜR PFOSTEN - - VIS DE FIXATION DES POTEAUX			8	3.5x50	
	SCREW FOR TERRACE REAR BOARDS - SCHRAUBEN FÜR TERRASSEN RAND - - VIS DE FIXATION POUR MAIN COURANTE DE TERRASSE			24	4x40	
	SCREW FOR ROOF BEAMS - SCHRAUBEN FÜR DACHBALKEN - - VIS POUR PANNE DE TOIT			28	5x120	
	SCREW FOR 1. WALL BEAM - SCHRAUBE FÜR 1. BOHLENREIHE - - VIS DE FIXATION DES FONDATIONS			11	5x90	
HS1	SCREW FOR DOOR JAMB - SCHRAUBE FÜR TÜRRAHMEN - - VIS DE FIXATION POUR MONTANT DE PORTE			6	5x90	
	SCREW FOR POST HEIGHT ADJUSTMENT - SCHRAUBEN FÜR REGULIERUNGSSCHRAUBE FÜR PFOSTEN - VIS DE FIXATION DE SUPPORT REGLABLE DE POTEAU			32	6x50	
	SCREW FOR DOOR FILLET - SCHRAUBE ZUR BEFESTIGUNG TÜRLEISTE - VIS D'ASSEMBLAGE DU CADRE DE PORTE			5	3x30	

Pos	28.01.2013	Piecelist - Stücklist - Liste des composants Art.Nr. 407499	11/12	Q.	P. (mm)	L. (mm)
		SCREW FOR EAVES BOARDS - SCHRAUBEN FÜR TRAUFBRETT - VIS DE FIXATION POUR BANDEAU DE TOIT		32	4x40	
		SCREW FOR FUNDAMENT - SCHRAUBEN ZUR BEFESTIGUNG FUNDAMENT - VIS POUR FONDATION		41	5x90	
		SCREW FOR BEAM HOLDER - SCHRAUBEN FÜR BALKENHALTER - VIS DE FIXATION SUPPORT U GALVANISÉ		120	4x40	
		ZN NAIL FOR FLOOR FILLET - ZN NÄGEL FÜR FUSSBODENLEISTE - POINTE POUR CORNIERE DE FINITION DU PLANCHER		30	1.4x40	
		SET OF DOOR LOCK COVERS - SCHLOSSBLENDEN - SET DE GARNITURES DE SERRURE DE PORTE		1		
		HAMMER BLOCK - SCHLAGHOLZ - CALLE DE FRAPPE		1		
		SCREW FOR DOORSTEP - SCHRAUBEN FÜR SWELLE - VIS DE FIXATION DU SEUIL DE PORTE		3	4.5x65	
		ZN NAIL FOR ROOF - ZN NÄGEL FÜR DACHBRETT - POINTE POUR TOIT		626	2x50	
		ZN NAIL FOR FLOOR - ZN NÄGEL FÜR FUSSBODENBRETT - CLOUS POUR PLANCHER		344	2x50	
		ZN NAIL FOR ROOFING FELT FILLET - ZN NÄGEL FÜR DACHPAPPENLEISTE - POINTE POUR BAGUETTE FIXATION FEUTRE BITUMEUX		24	2x40	
		BOLT FOR WINDOW HANDLE FITTINGS - BOLZEN FÜR FENSTERGRIFF BESCHLAG - BOULON POUR POIGNÉE D'OUVERTURE DE FENETRE		2		
		MALE BOLT HINGE FOR DOOR - TÜRRIEGEL - PARTIE MALE DE CHARNIERE DE PORTE		6		
		SCREW FOR GABLE MOULDING - SCHRAUBEN FÜR GIEBELLEISTE - VIS DE FIXATION POUR PLANCHE DE RIVE		32	3.5x50	
		SCREW FOR ROOF EDGE REINFORCEMENT - SCHRAUBEN FÜR DACHRANDVERSTÄRKUNG - VIS POUR RENFORT DE BORD DE TOIT		32	4x40	
		GABLE SEGMENT - DECKBLATT - LOSANGE DE FINITION		1		
		BEAM HOLDER - BALKENHALTER - SUPPORT EN U GALVANISÉ		10		
		NUT FOR STORM PROTECTION - SCHRAUBENMUTTER FÜR STURMLEISTE - ÉCROU POUR LAME ANTI-TEMPETE		8		
		BOLT FOR STORM PROTECTION - BOLZEN FÜR STURMLEISTE - VIS POUR LAME ANTI-TEMPETE		8		
		WASHER FOR STORM PROTECTION - DICHTSCHEIBE FÜR STURMLEISTE - RONDELLE POUR LAME ANTI-TEMPETE		8		
		DOOR HANDLE FITTINGS - TÜRGRIF - SET DE GARNITURES DE SERRURE DE PORTE		1		
		CYLINDER LOCK - ZYLINDERSCHLOSS - CYLINDRE DE SERRURE		1		
		POST HEIGHT ADJUSTMENT - REGULIERUNGSSCHRAUBE FÜR PFOSTEN - SUPPORT RÉGLABLE DE POTEAU		4		

Art.Nr. 407499

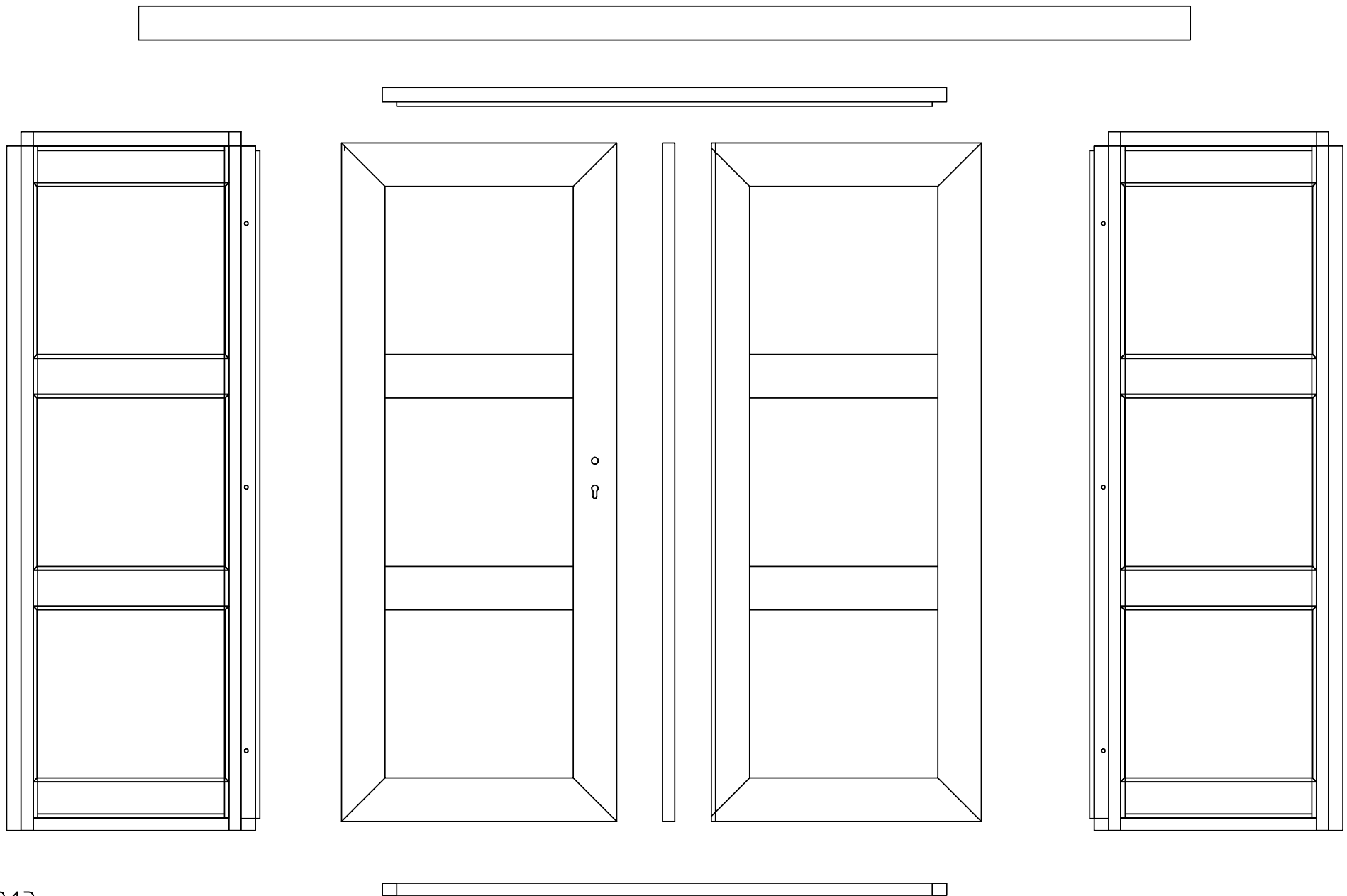

28.01.2013

1/3

Art.Nr. 407499

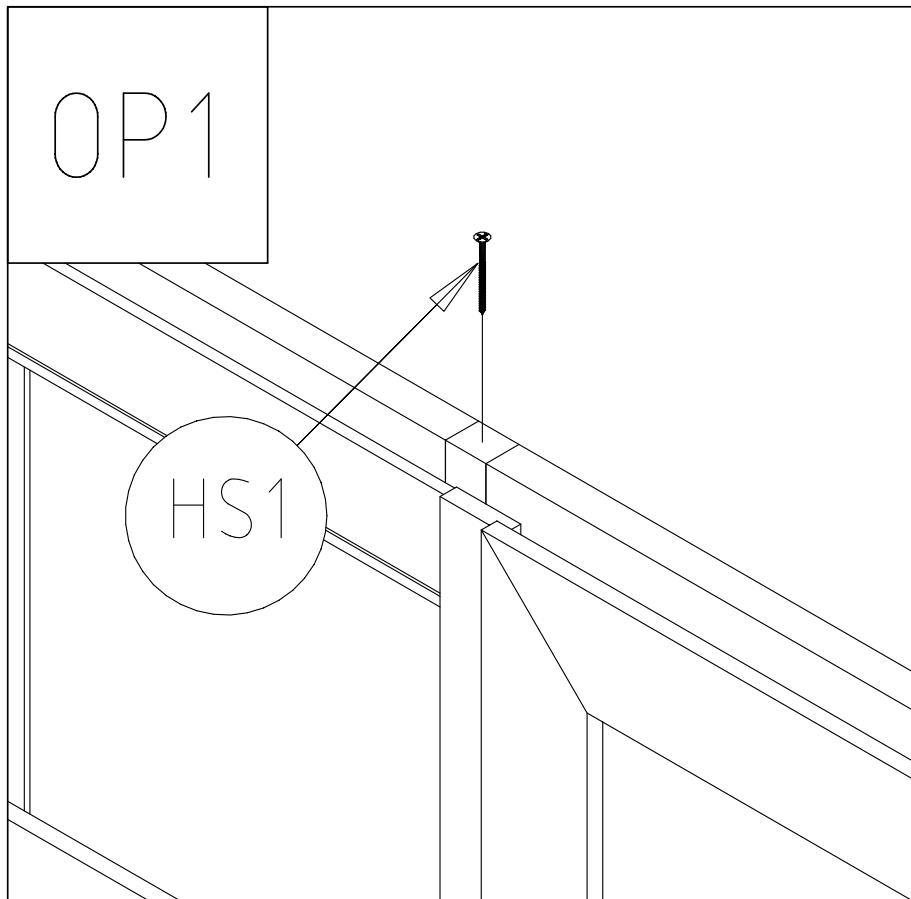
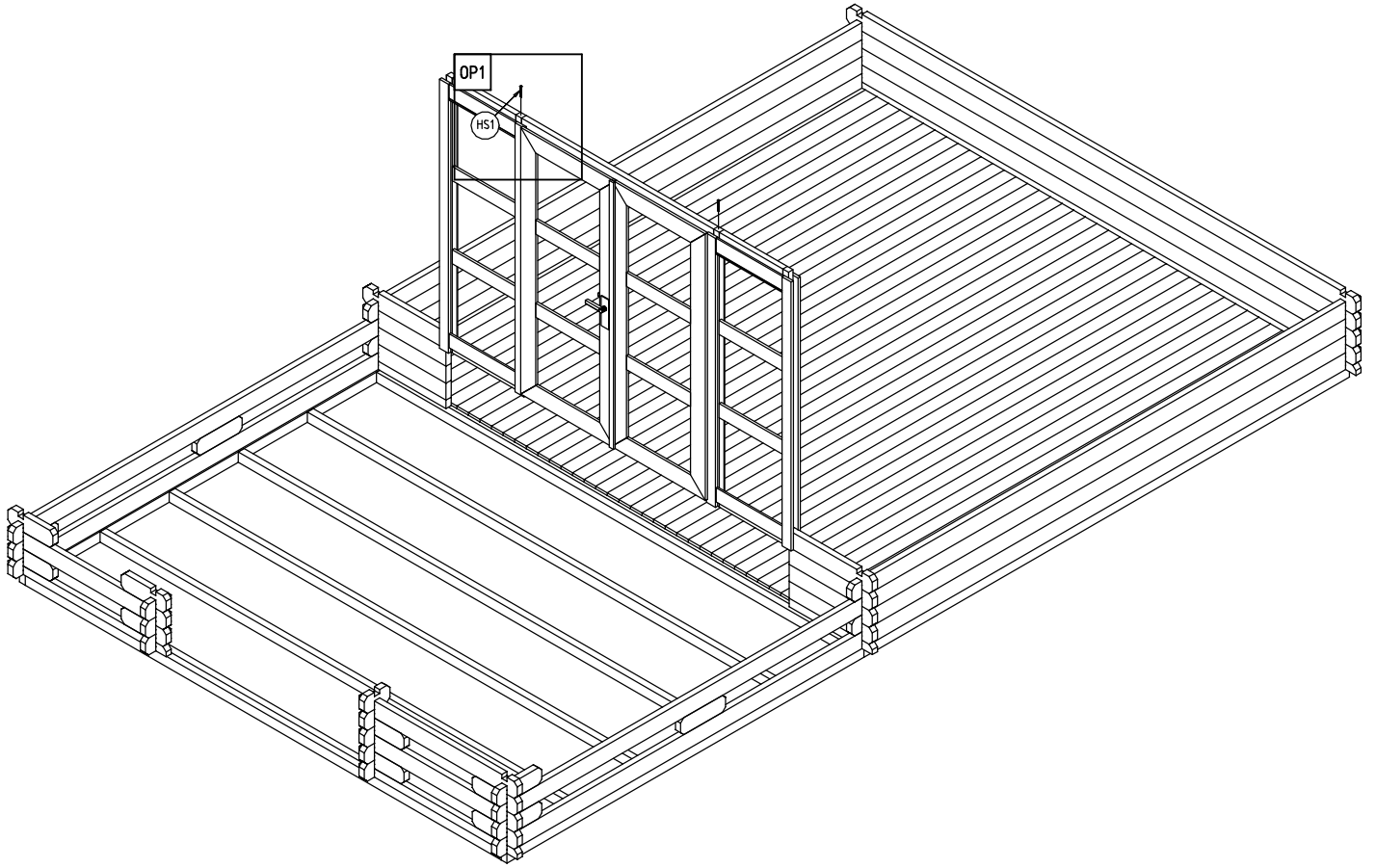

Art.Nr. 407499

